



Edition

11/2023

EQUIPMENT MANUAL

SIMATIC

S7-1500

CPU 1516-3 PN/DP
6ES7516-3AP03-0AB0

support.industry.siemens.com

SIEMENS

SIMATIC

S7-1500
CPU 1516-3 PN/DP
(6ES7516-3AP03-0AB0)

Equipment Manual

Introduction

1

Industrial cybersecurity

2

Product overview

3

Connecting up

4

Interrupts, error messages,
diagnostics and system
alarms

5

Technical specifications

6

Dimensional drawing

A



11/2023

A5E46418484-AD

Legal information

Warning notice system

This manual contains notices you have to observe in order to ensure your personal safety, as well as to prevent damage to property. The notices referring to your personal safety are highlighted in the manual by a safety alert symbol, notices referring only to property damage have no safety alert symbol. These notices shown below are graded according to the degree of danger.

 DANGER
indicates that death or severe personal injury will result if proper precautions are not taken.
 WARNING
indicates that death or severe personal injury may result if proper precautions are not taken.
 CAUTION
indicates that minor personal injury can result if proper precautions are not taken.
NOTICE
indicates that property damage can result if proper precautions are not taken.

If more than one degree of danger is present, the warning notice representing the highest degree of danger will be used. A notice warning of injury to persons with a safety alert symbol may also include a warning relating to property damage.

Qualified Personnel

The product/system described in this documentation may be operated only by **personnel qualified** for the specific task in accordance with the relevant documentation, in particular its warning notices and safety instructions. Qualified personnel are those who, based on their training and experience, are capable of identifying risks and avoiding potential hazards when working with these products/systems.

Proper use of Siemens products

Note the following:

 WARNING
Siemens products may only be used for the applications described in the catalog and in the relevant technical documentation. If products and components from other manufacturers are used, these must be recommended or approved by Siemens. Proper transport, storage, installation, assembly, commissioning, operation and maintenance are required to ensure that the products operate safely and without any problems. The permissible ambient conditions must be complied with. The information in the relevant documentation must be observed.

Trademarks

All names identified by ® are registered trademarks of Siemens AG. The remaining trademarks in this publication may be trademarks whose use by third parties for their own purposes could violate the rights of the owner.

Disclaimer of Liability

We have reviewed the contents of this publication to ensure consistency with the hardware and software described. Since variance cannot be precluded entirely, we cannot guarantee full consistency. However, the information in this publication is reviewed regularly and any necessary corrections are included in subsequent editions.

Table of contents

1	Introduction.....	5
1.1	Introduction.....	5
1.2	Guide documentation S7-1500/ET 200MP.....	6
1.2.1	Information classes S7-1500/ET 200MP.....	6
1.2.2	SIMATIC Technical Documentation.....	8
2	Industrial cybersecurity.....	10
2.1	Introduction to industrial cybersecurity.....	10
2.2	Cybersecurity information.....	10
2.3	Cybersecurity-relevant information.....	11
3	Product overview.....	13
3.1	New functions.....	13
3.2	Application.....	15
3.3	Hardware properties.....	22
3.4	Firmware functions.....	24
3.5	Operating and display elements.....	27
3.5.1	Front view of the CPU with closed front panel.....	27
3.5.2	Front view of the CPU without front flap and view from below.....	29
3.5.3	Rear view of the CPU.....	31
3.6	Operating mode buttons.....	31
4	Connecting up.....	33
5	Interrupts, error messages, diagnostics and system alarms.....	37
5.1	Status and error display of the CPU.....	37
6	Technical specifications.....	41
A	Dimensional drawing.....	57

Introduction

1.1 Introduction

Purpose of the documentation

This manual supplements the system manual of the S7-1500 automation system/ET 200MP distributed I/O system as well as the function manuals. This manual contains a description of the module-specific information. The system-related functions are described in the system manual. All system-spanning functions are described in the function manuals.

The information provided in this equipment manual and the system manual enables you to commission the CPU .

Conventions

STEP 7: In this documentation, "STEP 7" is used as a synonym for all versions of the configuration and programming software "STEP 7 (TIA Portal)".

Please also observe notes marked as follows:

NOTE

A note contains important information on the product described in the documentation, on the handling of the product or on the section of the documentation to which particular attention should be paid.

Recycling and disposal

For environmentally friendly recycling and disposal of your old equipment, contact a certified electronic waste disposal company and dispose of the equipment according to the applicable regulations in your country.

Industry Mall

The Industry Mall is the catalog and order system of Siemens AG for automation and drive solutions on the basis of Totally Integrated Automation (TIA) and Totally Integrated Power (TIP).

You can find catalogs for all automation and drive products on the Internet (<https://mall.industry.siemens.com>).

ID link for the digital nameplate



The ID link is a globally unique identifier according to IEC 61406-1, which you will find in the future as a QR code on your product.

The figure shows an example of an ID link for the CPU 1516-3 PN/DP.

You can recognize the ID link by the frame with a black corner at the bottom right. The ID link takes you to the digital nameplate of your product.

Scan the QR code on the product or on the packaging label with a smartphone camera, barcode scanner, or reader app. Call the ID link.

In the digital nameplate, you will find product data, manuals, declarations of conformity, certificates, and other helpful information about your product.

1.2 Guide documentation S7-1500/ET 200MP

1.2.1 Information classes S7-1500/ET 200MP



The documentation for the SIMATIC S7-1500 automation system and the ET 200MP distributed I/O system is arranged into three areas.

This arrangement enables you to access the specific content you require. Changes and supplements to the manuals are documented in a Product Information.

You can download the documentation free of charge from the Internet

(<https://support.industry.siemens.com/cs/ww/en/view/109742691>).

Basic information



The System Manual and Getting Started describe in detail the configuration, installation, wiring and commissioning of the SIMATIC S7-1500 and ET 200MP systems.

The STEP 7 online help supports you in the configuration and programming.

Examples:

- Getting Started S7-1500
- S7-1500/ET 200MP System Manual
- Online help TIA Portal

Device information



Equipment manuals contain a compact description of the module-specific information, such as properties, wiring diagrams, characteristics and technical specifications.

Examples:

- Equipment Manuals CPUs
- Equipment Manuals Interface Modules
- Equipment Manuals Digital Modules
- Equipment Manuals Analog Modules
- Equipment Manuals Communications Modules
- Equipment Manuals Technology Modules
- Equipment Manuals Power Supply Modules

General information



The function manuals contain detailed descriptions on general topics relating to the SIMATIC S7-1500 and ET 200MP systems.

Examples:

- Function Manual Diagnostics
- Function Manual Communication
- Function Manual Motion Control
- Function Manual Web Server
- Function Manual Cycle and Response Times
- PROFINET Function Manual
- PROFIBUS Function Manual

Product Information

Changes and supplements to the manuals are documented in a Product Information. The Product Information takes precedence over the device and system manuals.

You can find the latest Product Information on the S7-1500 and ET 200MP systems on the Internet (<https://support.industry.siemens.com/cs/de/en/view/68052815>).

Manual Collection S7-1500/ET 200MP

The Manual Collection contains the complete documentation on the SIMATIC S7-1500 automation system and the ET 200MP distributed I/O system gathered together in one file. You can find the Manual Collection on the Internet.

(<https://support.industry.siemens.com/cs/ww/en/view/86140384>)

Manual Collection fail-safe modules

The Manual Collection contains the complete documentation on the fail-safe SIMATIC modules, gathered together in one file.

You can find the Manual Collection on the Internet.

(<https://support.industry.siemens.com/cs/de/en/view/109806400>)

SIMATIC S7-1500 comparison list for programming languages

The comparison list contains an overview of which instructions and functions you can use for which controller families.

You can find the comparison list on the Internet

(<https://support.industry.siemens.com/cs/ww/en/view/86630375>).

1.2.2 SIMATIC Technical Documentation

Additional SIMATIC documents will complete your information. You can find these documents and their use at the following links and QR codes.

The Industry Online Support gives you the option to get information on all topics. Application examples support you in solving your automation tasks.

Overview of the SIMATIC Technical Documentation

Here you will find an overview of the SIMATIC documentation available in Siemens Industry Online Support:



Industry Online Support International

(<https://support.industry.siemens.com/cs/ww/en/view/109742705>)

Watch this short video to find out where you can find the overview directly in Siemens Industry Online Support and how to use Siemens Industry Online Support on your mobile device:



Quick introduction to the technical documentation of automation products per video (<https://support.industry.siemens.com/cs/us/en/view/109780491>)



YouTube video: Siemens Automation Products - Technical Documentation at a Glance (<https://youtu.be/TwLSxxRQsA>)

Retention of the documentation

Retain the documentation for later use.

For documentation provided in digital form:

1. Download the associated documentation after receiving your product and before initial installation/commissioning. Use the following download options:

- Industry Online Support International: (<https://support.industry.siemens.com>)

The article number is used to assign the documentation to the product. The article number is specified on the product and on the packaging label. Products with new, non-compatible functions are provided with a new article number and documentation.

- ID link:

Your product may have an ID link. The ID link is a QR code with a frame and a black frame corner at the bottom right. The ID link takes you to the digital nameplate of your product. Scan the QR code on the product or on the packaging label with a smartphone camera, barcode scanner, or reader app. Call up the ID link.

2. Retain this version of the documentation.

Updating the documentation

The documentation of the product is updated in digital form. In particular in the case of function extensions, the new performance features are provided in an updated version.

1. Download the current version as described above via the Industry Online Support or the ID link.
2. Also retain this version of the documentation.

mySupport

With "mySupport" you can get the most out of your Industry Online Support.

Registration	You must register once to use the full functionality of "mySupport". After registration, you can create filters, favorites and tabs in your personal workspace.
Support requests	Your data is already filled out in support requests, and you can get an overview of your current requests at any time.
Documentation	In the Documentation area you can build your personal library.
Favorites	You can use the "Add to mySupport favorites" to flag especially interesting or frequently needed content. Under "Favorites", you will find a list of your flagged entries.
Recently viewed articles	The most recently viewed pages in mySupport are available under "Recently viewed articles".
CAX data	The CAX data area gives you access to the latest product data for your CAX or CAE system. You configure your own download package with a few clicks: <ul style="list-style-type: none"> • Product images, 2D dimension drawings, 3D models, internal circuit diagrams, EPLAN macro files • Manuals, characteristics, operating manuals, certificates • Product master data

You can find "mySupport" on the Internet. (<https://support.industry.siemens.com/My/ww/en>)

Application examples

The application examples support you with various tools and examples for solving your automation tasks. Solutions are shown in interplay with multiple components in the system - separated from the focus on individual products.

You can find the application examples on the Internet.
(<https://support.industry.siemens.com/cs/ww/en/ps/ae>)

Industrial cybersecurity

2.1 Introduction to industrial cybersecurity

Due to the digitalization and increasing networking of machines and industrial plants, the risk of cyber attacks is also growing. Appropriate protective measures are therefore mandatory, particularly in the case of critical infrastructure facilities.

Refer to the System Manual (<https://support.industry.siemens.com/cs/us/en/view/59191792>) for general information and measures regarding industrial cybersecurity.

This section provides an overview of security-related information pertaining to your SIMATIC device.

NOTE

Security-relevant changes to software or devices are documented in the section "New functions ([Page 13](#))".

2.2 Cybersecurity information

Siemens provides products and solutions with industrial cybersecurity functions that support the secure operation of plants, systems, machines, and networks.

In order to protect plants, systems, machines, and networks against cyber threats, it is necessary to implement – and continuously maintain – a holistic, state-of-the-art industrial cybersecurity concept. Siemens' products and solutions constitute one element of such a concept.

Customers are responsible for preventing unauthorized access to their plants, systems, machines and networks. Such systems, machines and components should only be connected to an enterprise network or the internet if and to the extent such a connection is necessary and only when appropriate security measures (e.g. firewalls and/or network segmentation) are in place.

For more information on protective industrial cybersecurity measures for implementation, please visit (<https://www.siemens.com/global/en/products/automation/topic-areas/industrial-cybersecurity.html>).

Siemens' products and solutions undergo continuous development to make them more secure. Siemens strongly recommends that product updates are applied as soon as they are available and that the latest product versions are used. Use of product versions that are no longer supported, and failure to apply the latest updates may increase customers' exposure to cyber threats.

To stay informed about product updates at all times, subscribe to the Siemens Industrial Cybersecurity RSS Feed under (<https://new.siemens.com/global/en/products/services/cert.html>).

2.3 Cybersecurity-relevant information

Note all cybersecurity-relevant information.

Topics with cybersecurity-relevant information	Reference
Operational application environment and security assumptions	
Requirements for the operational application environment of the system and security assumptions	This section is found in the System Manual (https://support.industry.siemens.com/cs/us/en/view/59191792).
Area of application	You can find the section Area of application (Page 15) in this Equipment Manual.
Security properties of the product	
<p>Access protection</p> <p>Physical protection:</p> <ul style="list-style-type: none"> You can protect the CPU against unauthorized access by locking the front flap. <p>Password protection</p> <p>You can also protect the CPU with a password.</p> <p>Password categories:</p> <ul style="list-style-type: none"> Password to protect confidential configuration data Password in the context of user management (UMAC) Password for display 	<p>Information on locking and on password protection can be found in this Equipment Manual in the section Operator controls and display elements (Page 27).</p> <p>Also note the information on the topic of access protection in the Protection section of the System Manual (https://support.industry.siemens.com/cs/us/en/view/59191792).</p>
<p>Integrated protection functions</p> <ul style="list-style-type: none"> The CPUs have integrated protection functions. 	<p>For information on the protection functions, refer to the "Overview of protection functions" section of the System Manual (https://support.industry.siemens.com/cs/us/en/view/59191792).</p>
<p>PROFINET Security Class 1</p> <ul style="list-style-type: none"> The device supports PROFINET Security Class 1. With the introduction of PROFINET Security Class 1, additional security settings have been integrated into the PROFINET communication. 	<p>Detailed information about PROFINET Security Class 1 and the additional security settings can be found in the PROFINET with STEP 7 Function Manual (https://support.industry.siemens.com/cs/us/en/view/49948856).</p>
Reading out and verifying signatures	You can find detailed information on reading and verifying signatures in the STEP 7 online help (TIA Portal).
Supported Ethernet services	<p>Information about supported services can be found in the section Technical specifications (Page 41).</p> <p>You can find detailed information on the supported Ethernet services in the Communication Function Manual (https://support.industry.siemens.com/cs/us/en/view/59192925).</p>
Interfaces, ports, protocols and services	
<p>Information on the following is security related:</p> <ul style="list-style-type: none"> Communications layer and communication role Default states Enabling/disabling ports and services 	<p>You can find detailed information on these topics in the Communication Function Manual (https://support.industry.siemens.com/cs/us/en/view/59192925).</p>
Secure operation	

2.3 Cybersecurity-relevant information

Topics with cybersecurity-relevant information	Reference
Corrective measures for known risks	Corrective measures for known risks are announced on the Siemens ProductCERT (https://siemens.com/productcert) Web page. For more information on SIEMENS ProductCERT, refer to the System Manual (https://support.industry.siemens.com/cs/us/en/view/59191792).
Security checks	Application-specific security measures such as cyclic checks of the configuration via checksums are described in the System Manual (https://support.industry.siemens.com/cs/us/en/view/59191792).
Recording Security events	Information on recording security events can be found in the "Safe operation of CPUs" section of the System Manual (https://support.industry.siemens.com/cs/us/en/view/59191792).
Secure decommissioning Products that contain security-relevant data must be securely decommissioned before disposal or resale.	Information on secure decommissioning can be found in the "Safe operation of the system" section of the System Manual (https://support.industry.siemens.com/cs/us/en/view/59191792).

Product overview

3.1 New functions

This section contains an overview of the most important new firmware functions of the CPU compared with the predecessor version CPU (V3.0).

New functions of the CPU in firmware version V3.1

New functions	Applications	Customer benefits
Integrated safety		
Syslog messages	The CPU stores syslog messages in a local cache (temporary memory). The messages can be forwarded to a syslog server.	The syslog server saves all syslog messages from its connected devices. The messages can be displayed on the interface of the server and potential security risks can be identified.
Local user management	As of TIA Portal version V19 and FW version V3.1, the CPUs feature improved management of users, roles, and CPU function rights (User Management & Access Control, UMAC). Starting with the above mentioned version, you can manage all project users with their rights (e.g. access rights) for all CPUs in the project. You can do this in the editor for users and roles in the TIA Portal.	Project users can be managed via the TIA Portal with their rights (for example, access rights) for all CPUs in the project in the editor for users and roles.
Communication of the CPU		
Implementation of PROFINET Security Class 1	As of V19, STEP 7 offers extended configuration options for the SNMP and DCP protocols in order to meet the requirements for PROFINET Security Class 1.	Additional protection of communication within your PROFINET network.
Project-internal shared device/shared I-device	As of STEP7 V19, a shared device/shared I-device together with a maximum of two IO controllers can be created in a single project. Previously, the second IO controller required its own project.	Simpler configuration.
Handling timeouts while exchanging data	When network loads are high, timeouts may occur in PROFINET IO devices during data record communication. Previously, the PROFINET IO communication was reduced by the CPU in this case. As of STEP 7 V19 and FW version V3.1, you can configure the behavior of the respective PROFINET interface.	PROFINET IO communication is maintained even under high grid loads
Web server of the CPU		
New Web API methods:	Many new API methods extend your access options to the CPU via the Web API.	Additional applications for the web server
Technology functions of the CPU		

3.1 New functions

New functions	Applications	Customer benefits
Axis functions	Measuring gearbox for positioning/synchronous axis	Advanced configuration options
	Torque feedforward control for positioning/synchronous axis: The torque feedforward control of the CPU controls the torque required to accelerate the axis, taking into account the motion profile.	Complex motion sequences can be executed faster and more precisely. This leads to a reduction of following errors in acceleration phases.
	Three drive stop modes can be configured for the alarm response "Remove enable".	You can choose between a deceleration ramp, coasting down, and rapid stop.
	Dynamic filter with floating mean value	The new "Floating mean value filter" mode is available for the dynamic filter.
	Standstill signal on external encoder	The standstill signal is also available for external encoders. The standstill signal is output when the encoder values are within the defined standstill window.
	Virtual axis	The axis is operated in the virtual mode with improved runtime behavior. The new mode replaces the existing behavior of the virtual axis.
Measuring input functions	Monitoring measuring input	With the "Measuring via monitoring" measuring input type, the measuring input can capture the measured signal of another configured measuring input.
	Cyclic measuring for central measuring input	Cyclic measuring possible without additional technology module
Trace functionality of the CPU		
Live monitoring for the long-term trace	With live monitoring for the long-term trace, you can: <ul style="list-style-type: none"> • Display and analyze values directly in the graph during recording • Use superimposed measurements for the long-term trace • Synchronize time bases 	Improved display and analysis of long-term traces
Long-term project trace	With the long-term project trace, you can record signals of different S7-1500 CPUs simultaneously. The CPUs must be configured in a network. The recording is stored on a drive that you have configured.	Extended scope of functions

Reference

You can find an overview of all new functions, improvements and revisions in the respective firmware versions on the Internet (<https://support.industry.siemens.com/cs/ww/en/view/109478459>).

3.2 Application

SIMATIC S7-1500 is the modular control system for a wide variety of automation applications in discrete automation.

SIMATIC S7-1500 is the cost-effective and convenient solution for a broad range of tasks and offers the following advantages:

- Modular, fanless design
- Simple realization of distributed structures
- User-friendly handling

Areas of application of the SIMATIC S7-1500 automation system include, for example:

- Special-purpose machines
- Textile machinery
- Packaging machines
- General mechanical engineering
- Controller engineering
- Machine tool engineering
- Installation engineering
- Electrical industry and crafts
- Automobile engineering
- Water/waste water
- Food & Beverage

Areas of application of the SIMATIC S7-1500R/H redundant system include, for example:

- Tunnels
- Airports (e.g. baggage conveyors)
- Subways
- Shipbuilding
- Wastewater treatment plants
- High-bay warehouses

Areas of application of the SIMATIC S7-1500T automation system for advanced motion control applications include, for example:

- Packaging machines
- Converting applications
- Assembly automation
- Pick-and-place automation
- Palletizers

Several CPUs with various levels of performance and a comprehensive range of modules with many convenient features are available. Fail-safe CPUs enable use in fail-safe applications.

The modular design allows you to use only those modules that you need for your application. The controller can be retrofitted with additional modules at any time to expand its range of tasks.

High industrial suitability due to the high resistance to EMC, shock and vibration enable universal use of the SIMATIC S7-1500, S7-1500R/H and S7-1500T automation systems.

Performance segments of standard CPUs

The CPUs can be used for smaller and mid-range applications, as well as for the high-end range of machine and plant automation.

Table 3-1 Standard CPUs

CPU	Performance segment	PROFIBUS interfaces	PROFINET IO RT/IRT interfaces	PROFINET IO RT interface	Basic PROFINET functionality	Work memory	Processing time for bit operations
CPU 1511-1 PN	Standard CPU for small to mid-range applications	--	1	--	--	1.8 MB	25 ns
CPU 1513-1 PN	Standard CPU for mid-range applications	--	1	--	--	3.1 MB	25 ns
CPU 1515-2 PN	Standard CPU for mid-range to large applications	--	1	1	--	5.5 MB	6 ns
CPU 1516-3 PN/DP	Standard CPU for demanding applications and communication tasks	1	1	1	--	9.5 MB	6 ns
CPU 1517-3 PN/DP	Standard CPU for demanding applications and communication tasks	1	1	1	--	10 MB	2 ns
CPU 1518-4 PN/DP	Standard CPU for high-performance applications, demanding communication tasks and very short reaction times	1	1	1	1	66 MB	1 ns
CPU 1518-4 PN/DP MFP	Standard CPU for high-performance applications, demanding communication tasks, very short reaction times and C/C++ blocks for the user program	1	1	1	1	116* MB	1 ns

* 50 MB of the integrated work memory is reserved for the function library of CPU runtime

Performance segments of redundant CPUs

The CPUs of the S7-1500R/H redundant system offer a high degree of reliability and system availability. A redundant configuration of the most important automation components reduces the likelihood of production downtimes and the consequences of component errors. The higher the risks and costs of a production downtime, the more worthwhile the use of a redundant system. The avoidance of production downtimes compensates for the generally higher investment costs.

Table 3-2 Redundant CPUs

CPU	Performance segment	PROFIBUS interfaces	PROFINET IO RT/IRT interfaces	PROFINET IO RT interface	Basic PROFINET functionality	Work memory	Processing time for bit operations
CPU 1513R-1 PN	Redundant CPU for smaller to mid-range applications	--	1	--	--	3.1 MB	50 ns
CPU 1515R-2 PN	Redundant CPU for mid-range to large applications	--	1	--	1	5.5 MB	20 ns
CPU 1517H-3 PN	Redundant CPU for demanding applications and communication tasks	--	1	--	1	10 MB	4 ns
CPU 1518HF-4 PN	Fail-safe and redundant CPU for demanding applications and communication tasks	--	1	--	2	69 MB	4 ns

Performance segments of compact CPUs

The compact CPUs can be used for smaller to mid-range applications and have an integrated analog and digital on-board I/O as well as integrated technology functions.

Table 3-3 Compact CPUs

CPU	Performance segment	PROFIBUS interfaces	PROFINET IO RT/IRT interfaces	PROFINET IO RT interface	Basic PROFINET functionality	Work memory	Processing time for bit operations
CPU 1511C-1 PN	Compact CPU for small to mid-range applications	--	1	--	--	1.8 MB	25 ns
CPU 1512C-1 PN	Compact CPU for mid-range applications	--	1	--	--	2.4 MB	25 ns

The following table shows the specific properties of the Compact CPUs.

	CPU 1511C-1 PN	CPU 1512C-1 PN
Integrated analog inputs/outputs	5 inputs/2 outputs	5 inputs/2 outputs
Integrated digital inputs/outputs	16 inputs/16 outputs	32 inputs/32 outputs
High-speed counters	6	6
Frequency meters	6 (max. 100 kHz)	6 (max. 100 kHz)
Period duration measurement	6 channels	6 channels

3.2 Application

	CPU 1511C-1 PN	CPU 1512C-1 PN
Pulse width modulation (PWM output)	Max. 4 (up to 100 kHz)	Max. 4 (up to 100 kHz)
Pulse Train Output (PTO output)	Max. 4 (up to 100 kHz)	Max. 4 (up to 100 kHz)
Frequency output	Up to 100 kHz	Up to 100 kHz

Performance segments of technology CPUs

The technology CPUs can be used for low and mid-range applications, as well as for the high-end range of machine and plant automation. Because of their extended motion control functions, they are primarily used for drive control.

Table 3-4 Technology CPUs

CPU	Performance segment	PROFIBUS interfaces	PROFINET IO RT/IRT interfaces	PROFINET IO RT interface	Basic PROFINET functionality	Work memory	Processing time for bit operations
CPU 1511T-1 PN	Technology CPU for small to mid-range applications	--	1	--	--	1.95 MB	25 ns
CPU 1515T-2 PN	Technology CPU for mid-range to large applications	--	1	1	--	6 MB	6 ns
CPU 1516T-3 PN/DP	Technology CPU for high-end applications and communication tasks	1	1	1	--	10.5 MB	6 ns
CPU 1517T-3 PN/DP	Technology CPU for high-end applications and communication tasks	1	1	1	--	11 MB	2 ns
CPU 1518T-4 PN/DP	Technology CPU for high-performance motion control applications with large quantities, demanding communication tasks and very short reaction times	1	1	1	1	69 MB	1 ns
CPU 1511TF-1 PN CPU 1515TF-2 PN CPU 1516TF-3 P-N/DP CPU 1517TF-3 P-N/DP CPU 1518TF-4 P-N/DP	These CPUs are described in the fail-safe CPUs.						

Performance segments of fail-safe CPUs

The fail-safe CPUs are intended for users who want to implement demanding standard and fail-safe applications both centrally and decentrally.

These fail-safe CPUs allow the processing of standard and safety programs on a single CPU. This allows fail-safe data to be evaluated in the standard user program. The integration also provides the system advantages and the extensive functionality of SIMATIC for fail-safe applications.

The fail-safe CPUs are certified for use in safety mode up to:

- Safety class (Safety Integrity Level) SIL 3 according to IEC 61508:2010
- Performance Level (PL) e and Category 4 according to ISO 13849-1:2015 or EN ISO 13849-1:2015

For IT security, local user management can be used to individually restrict F-Configuration and F-Program access for users.

Table 3-5 Fail-safe CPUs

CPU	Performance segment	PROFIBUS interfaces	PROFINET IO RT/IRT interfaces	PROFINET IO RT interface	Basic PROFINET functionality	Work memory	Processing time for bit operations
CPU 1511F-1 PN	Fail-safe CPU for small to mid-range applications	--	1	--	--	1.95 MB	25 ns
CPU 1511TF-1 PN	Fail-safe technology CPU for small to mid-range applications	--	1	--	--	1.95 MB	25 ns
CPU 1513F-1 PN	Fail-safe CPU for mid-range applications	--	1	--	--	3.4 MB	25 ns
CPU 1515F-2 PN	Fail-safe CPU for mid-range to large applications	--	1	1	--	6 MB	6 ns
CPU 1515TF-2 PN	Fail-safe technology CPU for high-end applications and communication tasks	--	1	1	--	6 MB	6 ns
CPU 1516F-3 PN/DP	Fail-safe CPU for demanding applications and communication tasks	1	1	1	--	10.5 MB	6 ns
CPU 1516TF-3 PN/DP	Fail-safe technology CPU for high-end applications and communication tasks	1	1	1	--	10.5 MB	6 ns
CPU 1517F-3 PN/DP	Fail-safe CPU for demanding applications and communication tasks	1	1	1	--	11 MB	2 ns
CPU 1517TF-3 PN/DP	Fail-safe technology CPU for high-end applications and communication tasks	1	1	1	--	11 MB	2 ns

* 50 MB of the integrated work memory is reserved for the function library of CPU runtime

3.2 Application

CPU	Performance segment	PROFIBUS interfaces	PROFINET IO RT/IRT interfaces	PROFINET IO RT interface	Basic PROFINET functionality	Work memory	Processing time for bit operations
CPU 1518F-4 PN/DP	Fail-safe CPU for high-performance applications, demanding communication tasks and very short reaction times	1	1	1	1	69 MB	1 ns
CPU 1518F-4 PN/DP MFP	Fail-safe CPU for high-performance applications, demanding communication tasks, very short reaction times and C/C++ blocks for the user program	1	1	1	1	119* MB	1 ns
CPU 1518TF-4 P-N/DP	Technology CPU for high-performance motion control applications with large quantities, demanding communication tasks and very short reaction times	1	1	1	1	69 MB	1 ns

* 50 MB of the integrated work memory is reserved for the function library of CPU runtime

In addition to the CPUs, further components such as SINAMICS drives dispose of integrated safety functions. Additional information about integrated safety functions in drives can be found in the manuals for the respective products.

Security Integrated

In conjunction with STEP 7, each CPU offers password-based know-how protection against unauthorized reading out or modification of the program blocks.

Copy protection provides reliable protection against unauthorized reproduction of program blocks. With copy protection, individual blocks on the SIMATIC Memory Card are linked to its serial number so that the block can only be executed if the configured memory card is inserted in the CPU.

In addition, all project users can be managed via the local user management. Rights such as access rights can be set individually for each user.

Improved manipulation protection allows changed or unauthorized transfers of engineering data to be detected by the controller.

The use of an Ethernet CP (CP 1543-1) provides you with additional access protection through a firewall or possibilities to establish secure VPN connections.

Design and handling

All CPUs of the SIMATIC S7-1500 product series feature a display with plain text information. The display provides information on order numbers, firmware versions, and serial numbers of all connected modules. Additionally the IP address of the CPU and other network settings can be set directly on site, without a programming device. Error messages are shown on the display directly in plain text. When performing servicing, you can minimize plant downtimes by quickly accessing the diagnostics alarms. Detailed information about this and a multitude of other display functions is available in the SIMATIC S7-1500 Display Simulator (<https://support.industry.siemens.com/cs/ww/en/view/109761758>).

Uniform front connectors for all modules and integrated potential jumpers for flexible formation of potential groups simplify storage. Additional components such as circuit breakers, relays, etc., can be installed quickly and easily, since a DIN rail is implemented in the rail of the SIMATIC S7-1500. The CPUs of the SIMATIC S7-1500 product series can be expanded centrally and in a modular fashion with signal modules. Space-saving expansion enables flexible adaptation to each application.

The system cabling for digital signal modules enables fast and clear connection to sensors and actuators from the field (fully modular connection consisting of front connector modules, connection cables and I/O modules), as well as easy wiring inside the control cabinet (flexible connection consisting of front connectors with assembled single conductors).

System diagnostics and alarms

Integrated system diagnostics is activated by default for the CPUs. The different types of diagnostics are configured instead of programmed. System diagnostics information and alarms from the drives are displayed consistently and in plain text:

- On the CPU display
- In STEP 7
- On the HMI
- On the Web server

This information is available in RUN mode, but also in STOP mode of the CPU. The diagnostic information is updated automatically when you configure new hardware components.

The CPU is available as a central interrupt server in up to three project languages. The HMI takes over the display in the project languages defined for the CPU. If you require alarm texts in additional languages, you can load them into your HMI via the configured connection. The CPU, STEP 7 and their HMI ensure data consistency without additional engineering steps. The maintenance work is easier.

3.3 Hardware properties

Article number

6ES7516-3AP03-0AB0

View of the module

The figure below shows the CPU 1516-3 PN/DP.



Figure 3-1 CPU 1516-3 PN/DP

NOTE

Protective film

Please note that the CPU is supplied with a removable protective film on the display.

Properties

The 1516-3 PN/DP has the following technical properties:

Property	Description	Additional information
CPU display	All CPUs of the SIMATIC S7-1500 product series feature a display with plain text information. The display provides information on order numbers, firmware version and serial numbers of all connected modules. In addition, you can set the IP address of the CPU and make further network settings. The display shows occurring error messages directly in plain text. In addition to the functions listed here, a multitude of other functions that are described in the SIMATIC S7-1500 Display Simulator are shown on the display.	<ul style="list-style-type: none"> S7-1500, ET 200MP system manual (http://support.automation.siemens.com/WW/view/en/59191792) SIMATIC S7-1500 Display Simulator (https://support.industry.siemens.com/cs/ww/en/view/109761758)
Supply voltage	The 24 V DC supply voltage is fed in via a 4-pin plug located at the bottom of the CPU.	<ul style="list-style-type: none"> Section Connecting (Page 33) S7-1500, ET 200MP (http://support.automation.siemens.com/WW/view/en/59191792) system manual
PROFINET IO		
PROFINET interface (X1 P1R and X1 P2R)	The interface has two ports. In addition to basic PROFINET functionality, it also supports PROFINET IO RT (real time) and IRT (isochronous real time).	PROFINET (https://support.industry.siemens.com/cs/ww/en/view/49948856) function manual
PROFINET interface (X2 P1)	The interface has one port. In addition to basic PROFINET functionality, it also supports PROFINET IO RT (real time).	
Operation of the CPU as <ul style="list-style-type: none"> IO controller I-device 	<ul style="list-style-type: none"> IO controller: As an IO controller, the CPU addresses the connected IO devices I-device: As an I-device (intelligent IO device), the CPU is assigned to a higher-level IO controller and is used in the process as an intelligent pre-processing unit of sub-processes 	
PROFIBUS DP		
PROFIBUS interface (X3)	The interface is used for connecting to a PROFIBUS network.	PROFIBUS (https://support.industry.siemens.com/cs/ww/en/view/59193579) function manual
Operation of the CPU as a DP master	In the role as a DP master, the CPU addresses the connected DP slaves. It is not possible for the CPU to take the role of a DP slave.	

Accessories

You can find information on "Accessories/spare parts" in the S7-1500, ET 200MP system manual (<http://support.automation.siemens.com/WW/view/en/59191792>).

3.4 Firmware functions

Functions

The CPU 1516-3 PN/DP supports the following firmware functions:

Function	Description	Additional information
Integrated system diagnostics	The system automatically generates the alarms for system diagnostics and outputs the alarms via a programming device/PC, HMI device, the web server or the integrated display. System diagnostics information is also available when the CPU is in STOP mode.	Diagnostics function manual (https://support.industry.siemens.com/cs/ww/en/view/59192926)
Integrated web server	The web server allows you to access CPU data over a network. Evaluations, diagnostics, and modifications are thus possible over long distances. Monitoring and evaluation is possible without STEP 7; all you need is a Web browser. Make sure that you take appropriate measures (e.g. limiting network access, using firewalls) to protect the CPU from being compromised.	<ul style="list-style-type: none"> Web server Function Manual (https://support.industry.siemens.com/cs/ww/en/view/59193560) Security with SIMATIC S7 Controllers system manual (https://support.industry.siemens.com/cs/ww/en/view/90885010)
Integrated trace functionality	<p>Trace functionality supports you in troubleshooting and/or optimizing the user program.</p> <p>You can record device tags and evaluate the recordings with the trace and logic analyzer function. Tags are, for example, drive parameters or system and user tags of a CPU.</p> <p>The device saves the recordings. You can read out and permanently save the recordings with the configuration system (ES), if required. The trace and logic analyzer function is therefore suitable for monitoring highly dynamic processes.</p> <p>The trace recording can also be displayed via the web server.</p> <p>With the project trace, you record the tags of multiple devices within a project, for example, a controller and a drive.</p> <p>With the long-term trace, you record up to 64 different tags for each cycle in a .csv file over an extended period (e.g. hours, days).</p>	Function manual for trace and logic analyzer function (http://support.automation.siemens.com/WW/view/en/64897128)
OPC UA	<p>With OPC UA, data is exchanged via an open and vendor-neutral communication protocol.</p> <p>The CPU can act as OPC UA server. The CPU can communicate with OPC UA clients as an OPC UA server.</p> <p>In turn, the CPU can access an OPC UA server as OPC UA client, allow the OPC UA server to run methods and read out information from the OPC UA server.</p> <p>Through OPC UA Companion Specification, methods can be specified in a uniform and vendor-neutral way. The specified methods enable you to integrate devices from a wide range of manufacturers into your plants and production processes more easily.</p>	Communication function manual (https://support.industry.siemens.com/cs/ww/en/view/59192925)

Function	Description	Additional information
Configuration control	The configuration control allows you to handle different real hardware configurations with a maximum hardware configuration. Especially in series machine manufacturing, this means that you have the option of operating/configuring different expansion variants of a machine within a single project.	S7-1500, ET 200MP system manual (http://support.automation.siemens.com/WW/view/en/59191792)
PROFINET IO		
RT (real time)	RT prioritizes PROFINET IO frames over standard frames. This ensures the required determinism in the automation technology. In this process, the data is transferred via prioritized Ethernet frames.	PROFINET function manual (https://support.industry.siemens.com/cs/ww/en/view/49948856)
IRT (isochronous real time)	A reserved bandwidth within the send clock is available for IRT data. The reserved bandwidth ensures that the IRT data can be transmitted in time-synchronized intervals, unaffected by other high network loads (e.g. TCP/IP communication or additional real time communication). Update times with maximum determinism can be realized through IRT. Isochronous applications are possible with IRT.	
Isochronous mode	The Isochronous mode system property records measured values and process data and processes the signals in a fixed system clock. Isochronous mode contributes to high control quality and hence to greater manufacturing precision. Isochronous mode reduces potential fluctuations of the process reaction times to a minimum. Time-assured processing makes higher machine cycles possible.	
MRP (Media Redundancy Protocol)	It is possible to establish redundant networks via the Media Redundancy Protocol. Redundant transmission links (ring topology) ensure that an alternative communication path is made available if a transmission link fails. The PROFINET devices that are part of this redundant network form an MRP domain. RT operation is possible with the use of MRP.	
MRPD (Media Redundancy with Planned Duplication)	The advantage of the MRP extension MRPD is that, in the event of a failure of a device or a line in the ring, all other devices continue to be supplied with IO data without interruption and with short update times. MRPD is based on IRT and MRP. To realize media redundancy with short update times, the PROFINET devices participating in the ring send their data in both directions. The devices receive this data at both ring ports so that there is no ring reconfiguration time.	
Shared device	The "Shared device" function allows you to divide the modules or submodules of an IO device up among different IO controllers. Numerous IO controllers are often used in larger or widely distributed systems. Without the "Shared device" function, each I/O module of an IO device is assigned to the same IO controller. If sensors that are physically close to each other must provide data to different IO controllers, several IO devices are required. The "Shared device" function allows the modules or submodules of an IO device to be divided up among different IO controllers, thus allowing flexible	

3.4 Firmware functions

Function	Description	Additional information
	automation concepts. You can, for example, combine I/O modules that are physically close to each other in one IO device.	PROFINET function manual (https://support.industry.siemens.com/cs/ww/en/view/49948856)
PROFInergy	PROFInergy is a PROFINET-based data interface for switching off consumers centrally and with full coordination during pause times regardless of the manufacturer or device type. The goal is that the process is only provided with the energy that is absolutely required. Most of the energy is saved by the process. The PROFINET device itself only contributes a few watts to the savings potential.	
Integrated technology		
Motion Control	S7-1500 CPUs support the controlled positioning and traveling of axes via S7-1500 Motion Control functions by means of the following technology objects: Speed axes, positioning axes, synchronous axes, external encoders, output cams, cam tracks, and measuring inputs <ul style="list-style-type: none"> • Speed-controlled axis for controlling a drive with speed specification • Positioning axis for positioning of a drive with closed-loop position control • Synchronous axis to interconnect with a master value. The axis is synchronized to the master axis position • External encoder for detecting the actual position of an encoder and its use as a master value for synchronous operation • Cams, cam track for position-dependent generation of switching signals • Measuring input for fast, accurate and event-dependent sensing of actual positions 	S7-1500T Motion Control function manuals (https://support.industry.siemens.com/cs/ww/en/view/109751049)
Integrated closed-loop control functionality	<ul style="list-style-type: none"> • PID Compact (continuous PID controller) • PID 3Step (step controller for integrating actuators) • PID Temp (temperature controller for heating and cooling with two separate actuators) 	PID control (https://support.industry.siemens.com/cs/ww/en/view/108210036) function manual
Integrated safety		
Know-how protection	The know-how protection protects user blocks against unauthorized access and modifications.	S7-1500, ET 200MP (http://support.automation.siemens.com/WW/view/en/59191792) system manual
Copy protection	Copy protection links user blocks with the serial number of one or more SIMATIC Memory Cards or the serial number of one or more CPUs. User programs cannot run without the corresponding SIMATIC Memory Card or CPU.	
Local user management (as of FW version V3.1)	Improved management of users, roles, and CPU function rights (User Management & Access Control, UMAC). You can use the local user management in the editor to manage all project users along with their rights (e.g. access rights) for users and roles of the project in the TIA Portal.	

Function	Description	Additional information
Access protection (up to FW version V3.0)	You can use authorization levels to assign separate rights to different users.	S7-1500, ET 200MP (http://support.automation.siemens.com/WW/view/en/59191792) system manual
Integrity protection	The CPUs feature an integrity protection function by default. This helps to detect any manipulation of the engineering data on the SIMATIC Memory Card or during data transfer between the TIA Portal and the CPU, and to check communication from a SIMATIC HMI system to the CPU for possible manipulation of engineering data. The user receives a corresponding message about manipulation of engineering data detected by the integrity protection.	
Password provider	As an alternative to manual password input, you can connect a password provider to STEP 7. A password provider offers the following advantages: <ul style="list-style-type: none"> • Convenient handling of passwords. STEP 7 reads in the password automatically for the blocks. This saves you time. • Optimum block protection because the users themselves do not know the password. 	

3.5 Operating and display elements

3.5.1 Front view of the CPU with closed front panel

The following figure shows the front view of the CPU 1516-3 PN/DP.

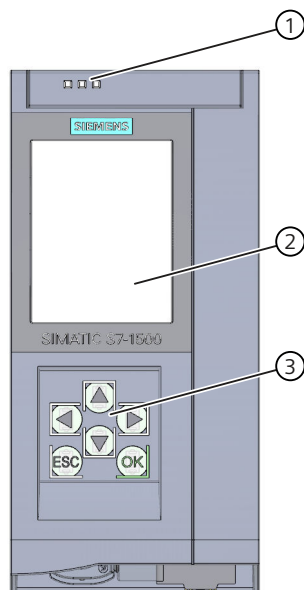

- ① LEDs for the current operating mode and diagnostic status of the CPU
- ② Display
- ③ Operator control buttons

Figure 3-2 View of the CPU 1516-3 PN DP (with front panel) - front

NOTE

Temperature range for display

To increase its service life, the display switches off at a temperature below the permitted operating temperature of the device. When the display cools down, it automatically switches itself on again. When the display is switched off, the LEDs continue to show the status of the CPU.

For more information on the temperatures at which the display switches itself on and off, refer to the Technical specifications [\(Page 41\)](#).

Removing and fitting the front panel or display

You can remove and fit the front panel or the display during operation.

! WARNING

Personal injury and damage to property may occur

Personal injury or material damage can occur in zone 2 hazardous areas if you remove or fit the display while the S7-1500 automation system is running.

Before you remove or insert the display in zone 2 hazardous areas, always make sure that the power supply to the S7-1500 automation system is switched off.

Locking the front panel

You can lock the front panel to protect the SIMATIC memory card and the operating mode buttons of the CPU against unauthorized access.

You can attach a security seal or a padlock with a diameter of 3 mm to the front panel.

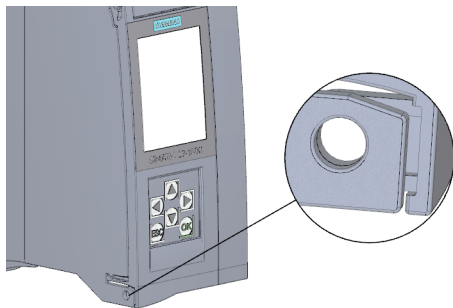

Figure 3-3 Locking latch on the CPU

In addition to the mechanical lock, you can also block access to a password-protected CPU on the display (local lock) and assign a password for the display. You can find additional information on the display, configurable protection levels and local locks in the S7-1500/ET 200MP <http://support.automation.siemens.com/WW/view/en/59191792> system manual.

Reference

You will find detailed information on the individual display options, a training course and a simulation of the available menu commands in the SIMATIC S7-1500 Display Simulator (<https://support.industry.siemens.com/cs/ww/en/view/109761758>).

3.5.2 Front view of the CPU without front flap and view from below

The figure below shows the operator controls and connection elements of the CPU 1516-3 PN/DP.

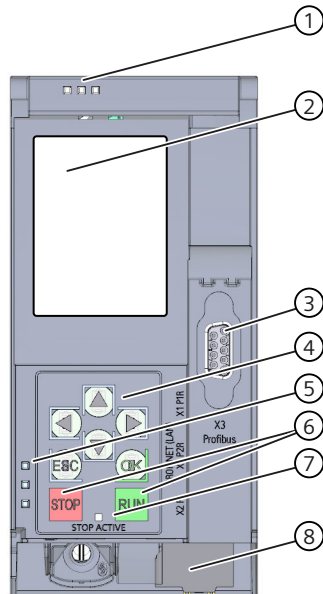

- ① LEDs for the current operating state and diagnostic status of the CPU
- ② Display
- ③ PROFIBUS interface (X3)
- ④ Arrow keys
- ⑤ LED displays for the PROFINET interface
- ⑥ STOP and RUN operating mode buttons
- ⑦ STOP-ACTIVE LED
- ⑧ Connector for the supply voltage

Figure 3-4 View of the CPU 1516-3 PN/DP (without front flap) – front

NOTE

Removing the display

Only remove the display if it is faulty.

You can find information on removing and replacing displays in the S7-1500, ET 200MP system manual (<http://support.automation.siemens.com/WW/view/en/59191792>).

3.5 Operating and display elements

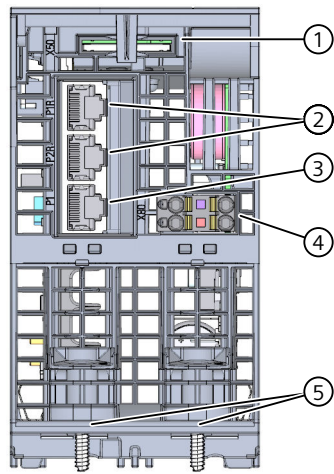

- ① Slot for the SIMATIC Memory Card
- ② PROFINET IO interface (X1) with 2 ports
- ③ PROFINET IO interface (X2) with 1 port
- ④ Connector for supply voltage
- ⑤ Fastening screw

Figure 3-5 View of the CPU 1516-3 PN/DP - bottom

3.5.3 Rear view of the CPU

The following figure shows the connection elements on the rear of the CPU 1516-3 PN/DP.

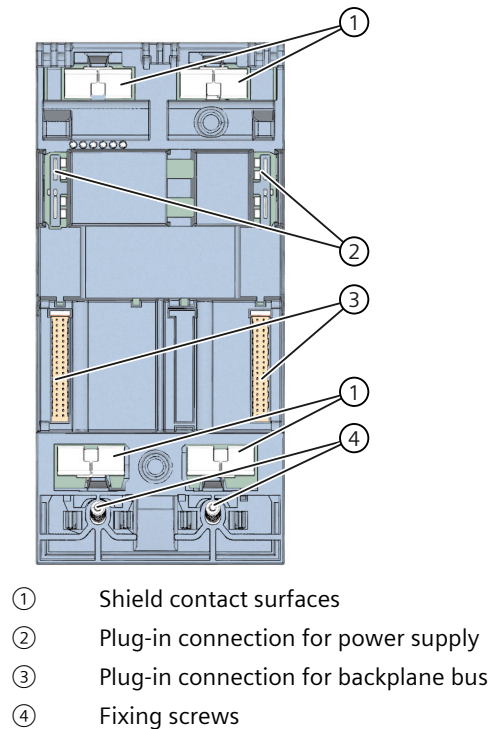

Figure 3-6 View of the CPU 1516-3 PN/DP - rear

3.6 Operating mode buttons

You use the operating mode buttons to:

- Request a change to a specific operating state
- Disable or enable the change to a specific operating state
 (if the operating mode button STOP is active, for example, you cannot switch the CPU to RUN via a communication task configured in the TIA Portal or via the display)

The following table shows the meaning of the corresponding operation of the operating mode buttons.

Table 3-6 Meaning of the operating mode buttons

Operation of the operating mode buttons	Meaning	Explanation
RUN	RUN mode	The CPU has permission to go to RUN.
STOP	STOP mode	The CPU does not have permission to go to RUN.
1. Press the operating mode button STOP. Result: The RUN/STOP LED lights up yellow.	Manual memory reset (with SIMATIC memory card inserted) or Reset to factory settings (without inserted SIMATIC memory card)	The CPU is executing a memory reset. or The CPU is being reset to factory settings. You can find additional information in the S7-1500/ET 200MP system manual

3.6 Operating mode buttons

Operation of the operating mode buttons	Meaning	Explanation
2. Press the operating mode button STOP until the RUN/STOP LED lights up for the 2nd time and remains continuously lit (this takes three seconds). After this, release the button. 3. Press the operating mode button STOP again within the next three seconds.		https://support.industry.siemens.com/cs/ww/en/view/59191792 .

Connecting up

This section provides information on the terminal assignment of the individual interfaces and the block diagram of the CPU 1516-3 PN/DP.

24 V DC supply voltage (X80)

The connector for the power supply is plugged in when the CPU ships from the factory. The following table shows the signal names and the descriptions of the pin assignment of the 24 V DC supply voltage.

Table 4-1 Pin assignment 24 V DC supply voltage

View	Signal name ¹⁾		Description
Connector			
	1	1L+	+ 24 V DC of the supply voltage
	2	1M	Ground of the supply voltage
	3	2M	Ground of the supply voltage for loop-through ²⁾
	4	2L+	+ 24 V DC of the supply voltage for loop-through ²⁾

¹⁾ 1L+ and 2L+ as well as 1M and 2M are bridged internally

²⁾ Maximum 10 A permitted

If the CPU is supplied by a system power supply, it is not necessary to connect the 24 V supply.

PROFINET interface X1 with 2-port switch (X1 P1R and X1 P2R)

The assignment corresponds to the Ethernet standard for an RJ45 plug.

- When autonegotiation is deactivated, the RJ45 socket is allocated as a switch (MDI-X).
- When autonegotiation is activated, autocrossing is in effect and the RJ45 socket is allocated either as data terminal equipment (MDI) or a switch (MDI-X).

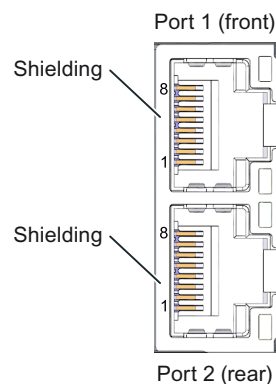

PROFINET interface X2 with 1 port (X2 P1)

The assignment corresponds to the Ethernet standard for an RJ45 plug. Autocrossing is always active on X2. This means the RJ45 socket is allocated either as data terminal equipment (MDI) or a switch (MDI-X).

Removing the PROFINET plug

You need a screwdriver (max. blade width 2.5 mm) to remove the PROFINET plug.

PROFIBUS interface X3

The table below shows the terminal assignment of the PROFIBUS interface. The assignment corresponds to the standard assignment of an RS485 interface.

Table 4-2 PROFIBUS interface terminal assignment

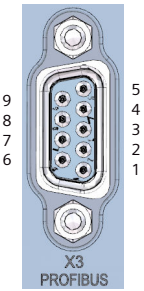
View	Signal name		Description
	1	-	-
	2	-	-
	3	RxD/TxD-P	Data line B
	4	RTS	Request To Send
	5	M5V2	Data reference potential (from station)
	6	P5V2	Supply plus (from station)
	7	-	-
	8	RxD/TxD-N	Data line A
	9	-	-

NOTE

Supply of I/O devices

The CPU 1516-3 PN/DP does not provide a 24 V DC power supply on the PROFIBUS interface. I/O devices (for example, PC adapter USB 6ES7972-0CB20-0XA0) are only operational on the interface in conjunction with a plug-in power supply set for external power supply.

The innovative successor product, PC adapter USB A2, receives the required power supply via the USB port. This means it does not need a 24 V DC supply voltage and can be operated **without** a plug-in power supply set for external power supply.

Removing the display

You can find a description of how to remove and replace the display in the S7-1500, ET 200MP (<http://support.automation.siemens.com/WW/view/en/59191792>) system manual.

Reference

You can find additional information on the topics of "Connecting the CPU" and "Accessories/spare parts" in the S7-1500, ET 200MP (<http://support.automation.siemens.com/WW/view/en/59191792>) system manual.

Assignment of the MAC addresses

CPU 1516-3 PN/DP has two PROFINET interfaces, with the first interface having two ports. The PROFINET interfaces each have a MAC address, and each of the PROFINET ports has its own MAC address. The CPU 1516-3 PN/DP therefore has five MAC addresses in total.

The MAC addresses of the PROFINET ports are needed for the LLDP protocol, for example for the neighborhood discovery function.

The number range of the MAC addresses is sequential. The first and last MAC addresses are printed on the rating plate on the right side of each CPU 1516-3 PN/DP.

The table below shows how the MAC addresses are assigned.

Table 4-3 Assignment of the MAC addresses

	Assignment	Labeling
MAC address 1	PROFINET interface X1 (visible in STEP 7 in accessible devices)	<ul style="list-style-type: none"> • Front, lasered • Right side, lasered (start of number range)
MAC address 2	Port X1 P1R (required for LLDP, for example)	<ul style="list-style-type: none"> • Front and right side, not lasered
MAC address 3	Port X1 P2R (required for LLDP, for example)	<ul style="list-style-type: none"> • Front and right side, not lasered
MAC address 4	PROFINET interface X2 (visible in STEP 7 in accessible devices)	<ul style="list-style-type: none"> • Front, lasered
MAC address 5	Port X2 P1 (required for LLDP, for example)	<ul style="list-style-type: none"> • Right side, lasered (end of number range)

Block diagram

The following figure shows the block diagram of the CPU 1516-3 PN/DP.

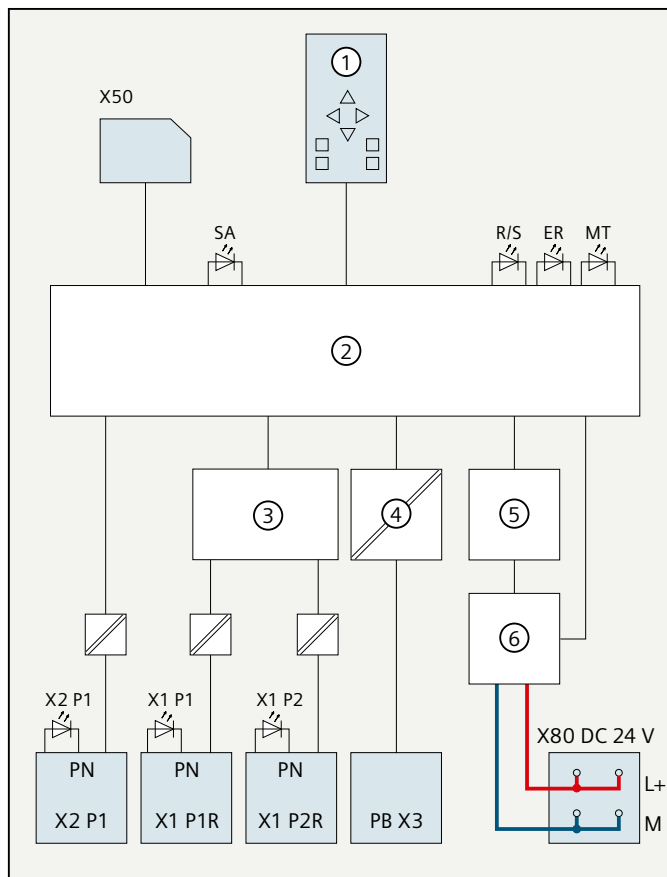

①	CPU with control and operating mode buttons	PN X2 P1	PROFINET interface X2 port 1
②	Electronics	PB X3	PROFIBUS interface X3
③	PROFINET 2-port switch	X80 24 V DC	Infeed of supply voltage
④	PROFIBUS DP driver	L+	24 V DC supply voltage
⑤	Backplane bus interface	Chassis ground	Ground
⑥	Internal supply voltage	SA	STOP-ACTIVE LED (yellow)
X50	SIMATIC memory card	R/S	RUN/STOP LED (green/yellow)
PN X1 P1R	PROFINET interface X1 port 1	ER	ERROR LED (red)
PN X1 P2R	PROFINET interface X1 port 2	MT	MAINT LED (yellow)
		X1 P1, X1 P2, X2 P1	LED Link TX/RX

Figure 4-1 Block diagram of the CPU 1516-3 PN/DP

Interrupts, error messages, diagnostics and system alarms

5

The LED displays of the CPU 1516-3 PN/DP are described below.

You will find additional information on "Interrupts" in the STEP 7 online help.

You can find additional information on the topics of "Diagnostics" and "System alarms" in the Diagnostics (<http://support.automation.siemens.com/WW/view/en/59192926>) function manual.

5.1 Status and error display of the CPU

LED display

The figure below shows the CPU 1516-3 PN/DP LEDs.

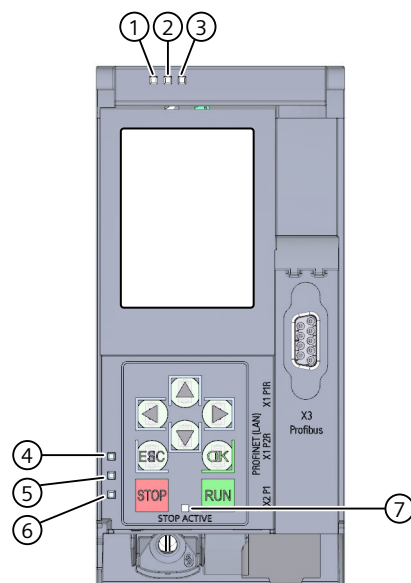

































- ① RUN/STOP LED (green/yellow LED)
- ② ERROR LED (red LED)
- ③ MAINT LED (yellow LED)
- ④ LINK RX/TX LED for port X1 P1 (yellow/green LED)
- ⑤ LINK RX/TX LED for port X1 P2 (yellow/green LED)
- ⑥ LINK RX/TX LED for port X2 P1 (yellow/green LED)
- ⑦ STOP-ACTIVE LED



Figure 5-1 LED display of the CPU 1516-3 PN/DP (without front flap)

Meaning of the RUN/STOP, ERROR and MAINT LEDs

The CPU 1516-3 PN/DP has three LEDs for displaying the current operating state and diagnostic status. The following table shows the meaning of the various combinations of colors for the RUN/STOP, ERROR and MAINT LEDs.

Table 5-1 Meaning of the LEDs





RUN/STOP LED	ERROR LED	MAINT LED	Meaning
 LED off	 LED off	 LED off	Missing or insufficient power supply on the CPU.
 LED off	 LED flashes red	 LED off	An error has occurred.
 LED lit green	 LED off	 LED off	CPU is in RUN mode.
 LED lit green	 LED off	 LED lit yellow	Maintenance demanded for the plant. You need to promptly check/replace the affected hardware within a short period of time.
			Active Force job
			OPC UA server of the CPU expects initial trust lists and CRLs via GDS Push function.
 LED lit green	 LED off	 LED flashes yellow	Bad configuration
 LED lit yellow	 LED flashes red	 LED off	A diagnostics event is pending.
 LED lit yellow	 LED off	 LED flashes yellow	Firmware update using SIMATIC Memory Card successfully completed.
 LED lit yellow	 LED off	 LED off	CPU is in STOP mode.
			CPU runs a program with active breakpoints. The program is at a breakpoint.
 LED lit yellow	 LED flashes red	 LED flashes yellow	The program on the SIMATIC memory card is causing an error.
			Firmware update using SIMATIC Memory Card has failed.
			The CPU has detected an error state. Additional information is available via the CPU diagnostic buffer.
 LED flashes yellow	 LED off	 LED off	CPU is performing internal activities during STOP, e.g. startup after STOP.
			Download of the user program from the SIMATIC memory card
			CPU is executing a program with active breakpoint. The program is presently moving from one breakpoint to another.
			Firmware update is being performed.
 LED flashes yellow/green	 LED off	 LED off	Startup (transition from STOP → RUN)

RUN/STOP LED	ERROR LED	MAINT LED	Meaning
 LED flashes yellow/green	 LED flashes red	 LED flashes yellow	Startup (CPU booting)
			Test of LEDs during startup, inserting a module.
			LED flashing test

Meaning of LINK RX/TX LED

Each port has a LINK RX/TX LED. The table below shows the various "LED scenarios" of the ports of the CPU 1516-3 PN/DP.

Table 5-2 Meaning of the LED

LINK TX/RX LED	Meaning
 LED off	There is no Ethernet connection between the PROFINET interface of the PROFINET device and the communication partner. No data is currently being sent/received via the PROFINET interface. There is no LINK connection.
 LED flashes green	The CPU is performing an "LED flash test".
 LED lit green	There is an Ethernet connection between the PROFINET interface of your PROFINET device and a communication partner.
 LED flashes yellow/green	Data is currently being received/sent by a communication partner in the Ethernet via the PROFINET interface of the PROFINET device.

NOTE

"LED" instruction

You can read the status (e.g. "On" or "Off") of LEDs of a CPU or a module using the "LED" instruction. Note, however, that it is not possible to read the LED status of the LINK RX/TX LEDs on all S7-1500 CPUs.

You can find additional information on the "LED" instruction in the STEP 7 online help.

Meaning of STOP-ACTIVE LED

The following table shows the meaning of the STOP-ACTIVE LED for the CPU 1516-3 PN/DP.

Table 5-3 Meaning of the LED

STOP-ACTIVE LED	Meaning
 LED lit yellow	The CPU has been switched to STOP mode using the STOP button.

5.1 Status and error display of the CPU

STOP-ACTIVE LED	Meaning
	<ul style="list-style-type: none"> • As long as the STOP-ACTIVE LED is lit, switching the CPU to RUN mode is only possible using the RUN button. • The CPU can then no longer be set to RUN mode via display operation or via online functions. The state of the buttons is retained at power-off. If the CPU should not start up automatically after a power-on, you have to keep the STOP button pressed during startup until the STOP-ACTIVE LED is activated. • If automatic startup is to be reliably prevented after a power-on, the STOP button has to be kept pressed during the startup of the CPU until the STOP-ACTIVE LED is activated.
<p style="text-align: center;">□ LED off</p>	<ul style="list-style-type: none"> • The CPU has been set to STOP mode using the display or programming device/PC and not with the STOP button on the device. • The CPU is in RUN mode.

Technical specifications

The following table shows the technical specifications as of 11/2023. You will find a data sheet including daily updated technical specifications on the Internet (<https://support.industry.siemens.com/cs/ww/en/pv/6ES7516-3AP03-0AB0/td?dl=en>).

Article number	6ES7516-3AP03-0AB0
General information	
Product type designation	CPU 1516-3 PN/DP
HW functional status	FS04
Firmware version	V3.1
<ul style="list-style-type: none"> FW update possible 	Yes
Product function	
<ul style="list-style-type: none"> I&M data 	Yes; I&M0 to I&M3
<ul style="list-style-type: none"> Isochronous mode 	Yes; Distributed and central; with minimum OB 6x cycle of 375 μ s (distributed) and 1 ms (central)
<ul style="list-style-type: none"> SysLog 	Yes
Engineering with	
<ul style="list-style-type: none"> STEP 7 TIA Portal configurable/integrated from version 	V19 (FW V3.1) / V18 (FW V3.0) or higher; with older TIA Portal versions configurable as 6ES7516-3AN02-0AB0
Configuration control	
via dataset	Yes
Display	
Screen diagonal [cm]	6.1 cm
Control elements	
Number of keys	8
Mode buttons	2
Supply voltage	
Rated value (DC)	24 V
permissible range, lower limit (DC)	19.2 V
permissible range, upper limit (DC)	28.8 V
Reverse polarity protection	Yes
Mains buffering	
<ul style="list-style-type: none"> Mains/voltage failure stored energy time 	5 ms
<ul style="list-style-type: none"> Repeat rate, min. 	1/s
Input current	
Current consumption (rated value)	0.69 A
Current consumption, max.	1.08 A
Inrush current, max.	1.15 A; Rated value
I^2t	0.6 A ² ·s

Article number	6ES7516-3AP03-0AB0
Power	
Infeed power to the backplane bus	12 W
Power consumption from the backplane bus (balanced)	6.7 W
Power loss	
Power loss, typ.	4 W
Memory	
Number of slots for SIMATIC memory card	1
SIMATIC memory card required	Yes
Work memory	
<ul style="list-style-type: none"> integrated (for program) 	2 Mbyte
<ul style="list-style-type: none"> integrated (for data) 	7.5 Mbyte
Load memory	
<ul style="list-style-type: none"> Plug-in (SIMATIC Memory Card), max. 	32 Gbyte
Backup	
<ul style="list-style-type: none"> maintenance-free 	Yes
CPU processing times	
for bit operations, typ.	6 ns
for word operations, typ.	7 ns
for fixed point arithmetic, typ.	9 ns
for floating point arithmetic, typ.	37 ns
CPU-blocks	
Number of elements (total)	8 000; Blocks (OB, FB, FC, DB) and UDTs
DB	
<ul style="list-style-type: none"> Number range 	1 ... 60 999; subdivided into: number range that can be used by the user: 1 ... 59 999, and number range of DBs created via SFC 86: 60 000 ... 60 999
<ul style="list-style-type: none"> Size, max. 	7.5 Mbyte; For DBs with absolute addressing, the max. size is 64 KB
FB	
<ul style="list-style-type: none"> Number range 	0 ... 65 535
<ul style="list-style-type: none"> Size, max. 	1 Mbyte
FC	
<ul style="list-style-type: none"> Number range 	0 ... 65 535
<ul style="list-style-type: none"> Size, max. 	1 Mbyte

Article number	6ES7516-3AP03-0AB0
OB	
<ul style="list-style-type: none"> • Size, max. 	1 Mbyte
<ul style="list-style-type: none"> • Number of free cycle OBs 	100
<ul style="list-style-type: none"> • Number of time alarm OBs 	20
<ul style="list-style-type: none"> • Number of delay alarm OBs 	20
<ul style="list-style-type: none"> • Number of cyclic interrupt OBs 	20; With minimum OB 3x cycle of 250 μs
<ul style="list-style-type: none"> • Number of process alarm OBs 	50
<ul style="list-style-type: none"> • Number of DPV1 alarm OBs 	3
<ul style="list-style-type: none"> • Number of isochronous mode OBs 	3
<ul style="list-style-type: none"> • Number of technology synchronous alarm OBs 	2
<ul style="list-style-type: none"> • Number of startup OBs 	100
<ul style="list-style-type: none"> • Number of asynchronous error OBs 	4
<ul style="list-style-type: none"> • Number of synchronous error OBs 	2
<ul style="list-style-type: none"> • Number of diagnostic alarm OBs 	1
Nesting depth	
<ul style="list-style-type: none"> • per priority class 	24
Counters, timers and their retentivity	
S7 counter	
<ul style="list-style-type: none"> • Number 	2 048
Retentivity	
– adjustable	Yes
IEC counter	
<ul style="list-style-type: none"> • Number 	Any (only limited by the main memory)
Retentivity	
– adjustable	Yes
S7 times	
<ul style="list-style-type: none"> • Number 	2 048
Retentivity	
– adjustable	Yes
IEC timer	
<ul style="list-style-type: none"> • Number 	Any (only limited by the main memory)
Retentivity	
– adjustable	Yes
Data areas and their retentivity	
Retentive data area (incl. timers, counters, flags), max.	512 kbyte; In total; available retentive memory for bit memories, timers, counters, DBs, and technology data (axes): 472 KB
Extended retentive data area (incl. timers, counters, flags), max.	7.5 Mbyte; When using PS 6 0W 24/48/60 V DC HF

Article number	6ES7516-3AP03-0AB0
Flag	
<ul style="list-style-type: none"> • Size, max. • Number of clock memories 	<p>16 kbyte</p> <p>8; 8 clock memory bit, grouped into one clock memory byte</p>
Data blocks	
<ul style="list-style-type: none"> • Retentivity adjustable • Retentivity preset 	<p>Yes</p> <p>No</p>
Local data	
<ul style="list-style-type: none"> • per priority class, max. 	64 kbyte; max. 16 KB per block
Address area	
Number of IO modules	8 192; max. number of modules / submodules
I/O address area	
<ul style="list-style-type: none"> • Inputs • Outputs 	<p>32 kbyte; All inputs are in the process image</p> <p>32 kbyte; All outputs are in the process image</p>
per integrated IO subsystem	
<ul style="list-style-type: none"> – Inputs (volume) – Outputs (volume) 	<p>8 kbyte</p> <p>8 kbyte</p>
per CM/CP	
<ul style="list-style-type: none"> – Inputs (volume) – Outputs (volume) 	<p>8 kbyte</p> <p>8 kbyte</p>
Subprocess images	
<ul style="list-style-type: none"> • Number of subprocess images, max. 	32
Hardware configuration	
Number of distributed IO systems	64; A distributed I/O system is characterized not only by the integration of distributed I/O via PROFINET or PROFIBUS communication modules, but also by the connection of I/O via AS-i master modules or links (e.g. IE/PB-Link)
Number of DP masters	
<ul style="list-style-type: none"> • integrated • Via CM 	<p>1</p> <p>8; A maximum of 8 CMs/CPs (PROFIBUS, PROFINET, Ethernet) can be inserted in total</p>
Number of IO Controllers	
<ul style="list-style-type: none"> • integrated • Via CM 	<p>2</p> <p>8; A maximum of 8 CMs/CPs (PROFIBUS, PROFINET, Ethernet) can be inserted in total</p>
Rack	
<ul style="list-style-type: none"> • Modules per rack, max. • Number of lines, max. 	<p>32; CPU + 31 modules</p> <p>1</p>
PtP CM	
<ul style="list-style-type: none"> • Number of PtP CMs 	the number of connectable PtP CMs is only limited by the number of available slots

Article number	6ES7516-3AP03-0AB0
Time of day	
Clock	
<ul style="list-style-type: none"> Type 	Hardware clock
<ul style="list-style-type: none"> Backup time 	6 wk; At 40 °C ambient temperature, typically
<ul style="list-style-type: none"> Deviation per day, max. 	10 s; Typ.: 2 s
Operating hours counter	
<ul style="list-style-type: none"> Number 	16
Clock synchronization	
<ul style="list-style-type: none"> supported 	Yes
<ul style="list-style-type: none"> to DP, master 	Yes
<ul style="list-style-type: none"> to DP, slave 	Yes
<ul style="list-style-type: none"> in AS, master 	Yes
<ul style="list-style-type: none"> in AS, slave 	Yes
<ul style="list-style-type: none"> on Ethernet via NTP 	Yes
Interfaces	
Number of PROFINET interfaces	2
Number of PROFIBUS interfaces	1
1. Interface	
Interface types	
<ul style="list-style-type: none"> RJ 45 (Ethernet) 	Yes; X1
<ul style="list-style-type: none"> Number of ports 	2
<ul style="list-style-type: none"> integrated switch 	Yes
Protocols	
<ul style="list-style-type: none"> IP protocol 	Yes; IPv4
<ul style="list-style-type: none"> PROFINET IO Controller 	Yes
<ul style="list-style-type: none"> PROFINET IO Device 	Yes
<ul style="list-style-type: none"> SIMATIC communication 	Yes
<ul style="list-style-type: none"> Open IE communication 	Yes; Optionally also encrypted
<ul style="list-style-type: none"> Web server 	Yes
<ul style="list-style-type: none"> Media redundancy 	Yes

Article number	6ES7516-3AP03-0AB0
PROFINET IO Controller	
Services	
– Isochronous mode	Yes
– Direct data exchange	Yes; Requirement: IRT and isochronous mode (MRPD optional)
– IRT	Yes
– PROFINET energy	Yes; per user program
– Prioritized startup	Yes; Max. 32 PROFINET devices
– Number of connectable IO Devices, max.	256; In total, up to 1 000 distributed I/O devices can be connected via AS-i, PROFIBUS or PROFINET
– Of which IO devices with IRT, max.	64
– Number of connectable IO Devices for RT, max.	256
– of which in line, max.	256
– Number of IO Devices that can be simultaneously activated/deactivated, max.	8; in total across all interfaces
– Number of IO Devices per tool, max.	8
– Updating times	The minimum value of the update time also depends on communication share set for PROFINET IO, on the number of IO devices, and on the quantity of configured user data
– PROFINET Security Class	1
Update time for IRT	
– for send cycle of 250 µs	250 µs to 4 ms; Note: In the case of IRT with isochronous mode, the minimum update time of 375 µs of the isochronous OB is decisive
– for send cycle of 500 µs	500 µs to 8 ms
– for send cycle of 1 ms	1 ms to 16 ms
– for send cycle of 2 ms	2 ms to 32 ms
– for send cycle of 4 ms	4 ms to 64 ms
– With IRT and parameterization of "odd" send cycles	Update time = set "odd" send clock (any multiple of 125 µs: 375 µs, 625 µs ... 3 875 µs)
Update time for RT	
– for send cycle of 250 µs	250 µs to 128 ms
– for send cycle of 500 µs	500 µs to 256 ms
– for send cycle of 1 ms	1 ms to 512 ms
– for send cycle of 2 ms	2 ms to 512 ms
– for send cycle of 4 ms	4 ms to 512 ms

Article number	6ES7516-3AP03-0AB0
PROFINET IO Device	
Services	
– Isochronous mode	No
– IRT	Yes
– PROFIenergy	Yes; per user program
– Shared device	Yes
– Number of IO Controllers with shared device, max.	4
– activation/deactivation of I-devices	Yes; per user program
– Asset management record	Yes; per user program
– PROFINET Security Class	SNMP Configuration and DCP Read Only
2. Interface	
Interface types	
• RJ 45 (Ethernet)	Yes; X2
• Number of ports	1
• integrated switch	No
Protocols	
• IP protocol	Yes; IPv4
• PROFINET IO Controller	Yes
• PROFINET IO Device	Yes
• SIMATIC communication	Yes
• Open IE communication	Yes; Optionally also encrypted
• Web server	Yes
• Media redundancy	No

Article number	6ES7516-3AP03-0AB0
PROFINET IO Controller	
Services	
– Isochronous mode	No
– Direct data exchange	No
– IRT	No
– PROFINergy	Yes; per user program
– Prioritized startup	No
– Number of connectable IO Devices, max.	32; In total, up to 1 000 distributed I/O devices can be connected via AS-i, PROFIBUS or PROFINET
– Number of connectable IO Devices for RT, max.	32
– of which in line, max.	32
– Number of IO Devices that can be simultaneously activated/deactivated, max.	8; in total across all interfaces
– Number of IO Devices per tool, max.	8
– Updating times	The minimum value of the update time also depends on communication share set for PROFINET IO, on the number of IO devices, and on the quantity of configured user data
– PROFINET Security Class	1
Update time for RT	
– for send cycle of 1 ms	1 ms to 512 ms
PROFINET IO Device	
Services	
– Isochronous mode	No
– IRT	No
– PROFINergy	Yes; per user program
– Prioritized startup	No
– Shared device	Yes
– Number of IO Controllers with shared device, max.	4
– activation/deactivation of I-devices	Yes; per user program
– Asset management record	Yes; per user program
– PROFINET Security Class	SNMP Configuration and DCP Read Only
3. Interface	
Interface types	
• RS 485	Yes; X3
• Number of ports	1

Article number	6ES7516-3AP03-0AB0
Protocols	
<ul style="list-style-type: none"> • PROFIBUS DP master • PROFIBUS DP slave • SIMATIC communication 	<p>Yes</p> <p>No</p> <p>Yes</p>
PROFIBUS DP master	
<ul style="list-style-type: none"> • Number of connections, max. • Number of DP slaves, max. 	<p>48; for the integrated PROFIBUS DP interface</p> <p>125; In total, up to 1 000 distributed I/O devices can be connected via AS-i, PROFIBUS or PROFINET</p>
Services	
<ul style="list-style-type: none"> – Equidistance – Isochronous mode – Activation/deactivation of DP slaves 	<p>Yes</p> <p>Yes</p> <p>Yes</p>
Interface types	
RJ 45 (Ethernet)	
<ul style="list-style-type: none"> • 100 Mbps • Autonegotiation • Autocrossing • Industrial Ethernet status LED 	<p>Yes</p> <p>Yes</p> <p>Yes</p> <p>Yes</p>
RS 485	
<ul style="list-style-type: none"> • Transmission rate, max. 	12 Mbit/s
Protocols	
PROFIsafe	No
Number of connections	
<ul style="list-style-type: none"> • Number of connections, max. • Number of connections reserved for ES/HMI/web • Number of connections via integrated interfaces • Number of S7 routing paths 	<p>256; via integrated interfaces of the CPU and connected CPs / CMs</p> <p>10</p> <p>128</p> <p>16</p>
Redundancy mode	
<ul style="list-style-type: none"> • H-Sync forwarding 	Yes
Media redundancy	
<ul style="list-style-type: none"> – Media redundancy – MRP – MRP interconnection, supported – MRPD – Switchover time on line break, typ. – Number of stations in the ring, max. 	<p>only via 1st interface (X1)</p> <p>Yes; MRP Automanager according to IEC 62439-2 Edition 2.0, MRP Manager; MRP Client</p> <p>Yes; as MRP ring node according to IEC 62439-2 Edition 3.0</p> <p>Yes; Requirement: IRT</p> <p>200 ms; For MRP, bumpless for MRPD</p> <p>50</p>

Article number	6ES7516-3AP03-0AB0
SIMATIC communication	
<ul style="list-style-type: none"> • PG/OP communication • S7 routing • Data record routing • S7 communication, as server • S7 communication, as client • User data per job, max. 	<p>Yes; encryption with TLS V1.3 pre-selected</p> <p>Yes</p> <p>Yes</p> <p>Yes</p> <p>Yes</p> <p>See online help (S7 communication, user data size)</p>
Open IE communication	
<ul style="list-style-type: none"> • TCP/IP <ul style="list-style-type: none"> – Data length, max. – several passive connections per port, supported • ISO-on-TCP (RFC1006) <ul style="list-style-type: none"> – Data length, max. • UDP <ul style="list-style-type: none"> – Data length, max. – UDP multicast • DHCP • DNS • SNMP • DCP • LLDP • Encryption 	<p>Yes</p> <p>64 kbyte</p> <p>Yes</p> <p>Yes</p> <p>64 kbyte</p> <p>Yes</p> <p>2 kbyte; 1 472 bytes for UDP broadcast</p> <p>Yes; max. 118 multicast circuits</p> <p>Yes</p> <p>Yes</p> <p>Yes</p> <p>Yes</p> <p>Yes</p> <p>Yes; Optional</p>
Web server	
<ul style="list-style-type: none"> • HTTP • HTTPS 	<p>Yes; Standard and user pages</p> <p>Yes; Standard and user pages</p>

Article number	6ES7516-3AP03-0AB0
OPC UA	
<ul style="list-style-type: none"> • Runtime license required • OPC UA Client <ul style="list-style-type: none"> – Application authentication – Security policies – User authentication – Number of connections, max. – Number of nodes of the client interfaces, recommended max. – Number of elements for one call of OPC-UA_NodeGetHandleList/OPC-UA_ReadList/OPC-UA_WriteList, max. – Number of elements for one call of OPC-UA_NameSpaceGetIndexList, max. – Number of elements for one call of OPC-UA_MethodGetHandleList, max. – Number of simultaneous calls of the client instructions for session management, per connection, max. – Number of simultaneous calls of the client instructions for data access, per connection, max. – Number of registerable nodes, max. – Number of registerable method calls of OPC-UA_MethodCall, max. – Number of inputs/outputs when calling OPC-UA_MethodCall, max. 	<p>Yes; "Medium" license required</p> <p>Yes; Data Access (registered Read/Write), Method Call</p> <p>Yes</p> <p>Available security policies: None, Basic128Rsa15, Basic256Rsa15, Basic256Sha256</p> <p>"anonymous" or by user name & password</p> <p>10</p> <p>2 000</p> <p>300</p> <p>20</p> <p>100</p> <p>1</p> <p>5</p> <p>5 000</p> <p>100</p> <p>20</p>

Article number	6ES7516-3AP03-0AB0
<ul style="list-style-type: none"> • OPC UA Server <ul style="list-style-type: none"> – Application authentication – Security policies – User authentication – GDS support (certificate management) – Number of sessions, max. – Number of accessible variables, max. – Number of registerable nodes, max. – Number of subscriptions per session, max. – Sampling interval, min. – Publishing interval, min. – Number of server methods, max. – Number of inputs/outputs per server method, max. – Number of monitored items, recommended max. – Number of server interfaces, max. – Number of nodes for user-defined server interfaces, max. • Alarms and Conditions <ul style="list-style-type: none"> – Number of program alarms – Number of alarms for system diagnostics 	Yes; Data Access (Read, Write, Subscribe), Method Call, Alarms & Condition (A&C), Custom Address Space Yes available security policies: None, Basic128Rsa15, Basic256Rsa15, Basic256Sha256, Aes128Sha256RsaOaep, Aes256Sha256RsaPss "anonymous" or by user name & password Yes 48 100 000 20 000 50 100 ms 100 ms 50 20 4 000; for 1 s sampling interval and 1 s send interval 10 of each "Server interfaces" / "Companion specification" type and 20 of the type "Reference namespace" 30 000 Yes 200 100
Further protocols <ul style="list-style-type: none"> • MODBUS 	Yes; MODBUS TCP
Isochronous mode Equidistance	Yes

Article number	6ES7516-3AP03-0AB0
S7 message functions	
Number of login stations for message functions, max.	64
number of subscriptions, max.	500
number of tags/attributes for subscriptions, max.	8 000
Program alarms	Yes
Number of configurable program messages, max.	10 000; Program messages are generated by the "Program_Alarm" block, ProDiag or GRAPH
Number of loadable program messages in RUN, max.	10 000
Number of simultaneously active program alarms	
<ul style="list-style-type: none"> • Number of program alarms 	1 000
<ul style="list-style-type: none"> • Number of alarms for system diagnostics 	200
<ul style="list-style-type: none"> • Number of alarms for motion technology objects 	160
Test commissioning functions	
Joint commission (Team Engineering)	Yes; Parallel online access possible for up to 8 engineering systems
Status block	Yes; Up to 8 simultaneously (in total across all ES clients)
Single step	No
Number of breakpoints	8
Profiling	Yes
Status/control	
<ul style="list-style-type: none"> • Status/control variable 	Yes
<ul style="list-style-type: none"> • Variables 	Inputs/outputs, memory bits, DBs, distributed I/Os, timers, counters
<ul style="list-style-type: none"> • Number of variables, max. 	
<ul style="list-style-type: none"> – of which status variables, max. 	200; per job
<ul style="list-style-type: none"> – of which control variables, max. 	200; per job
Forcing	
<ul style="list-style-type: none"> • Forcing 	Yes
<ul style="list-style-type: none"> • Forcing, variables 	Peripheral inputs/outputs
<ul style="list-style-type: none"> • Number of variables, max. 	200
Diagnostic buffer	
<ul style="list-style-type: none"> • present 	Yes
<ul style="list-style-type: none"> • Number of entries, max. 	3 200
<ul style="list-style-type: none"> – of which powerfail-proof 	500
Traces	
<ul style="list-style-type: none"> • Number of configurable Traces 	4
<ul style="list-style-type: none"> • Memory size per trace, max. 	512 kbyte

Article number	6ES7516-3AP03-0AB0
Interrupts/diagnostics/status information	
Diagnostics indication LED	
• RUN/STOP LED	Yes
• ERROR LED	Yes
• MAINT LED	Yes
• STOP ACTIVE LED	Yes
• Connection display LINK TX/RX	Yes
Supported technology objects	
Motion Control	Yes; Note: The number of technology objects affects the cycle time of the PLC program; selection guide via the TIA Selection Tool
• Number of available Motion Control resources for technology objects	2 400
• Required Motion Control resources	
– per speed-controlled axis	40
– per positioning axis	80
– per synchronous axis	160
– per external encoder	80
– per output cam	20
– per cam track	160
– per probe	40
• Positioning axis	
– Number of positioning axes at motion control cycle of 4 ms (typical value)	11
– Number of positioning axes at motion control cycle of 8 ms (typical value)	20
Controller	
• PID_Compact	Yes; Universal PID controller with integrated optimization
• PID_3Step	Yes; PID controller with integrated optimization for valves
• PID-Temp	Yes; PID controller with integrated optimization for temperature
Counting and measuring	
• High-speed counter	Yes
Standards, approvals, certificates	
Suitable for safety functions	No

Article number	6ES7516-3AP03-0AB0
Ambient conditions	
Ambient temperature during operation	
<ul style="list-style-type: none"> horizontal installation, min. horizontal installation, max. vertical installation, min. vertical installation, max. 	-30 °C; No condensation 60 °C; Display: 50 °C, at an operating temperature of typically 50 °C, the display is switched off -30 °C; No condensation 40 °C; Display: 40 °C, at an operating temperature of typically 40 °C, the display is switched off
Ambient temperature during storage/transportation	
<ul style="list-style-type: none"> min. max. 	-40 °C 70 °C
Altitude during operation relating to sea level	
<ul style="list-style-type: none"> Installation altitude above sea level, max. 	5 000 m; Restrictions for installation altitudes > 2 000 m, see manual
configuration / header	
configuration / programming / header	
Programming language	
<ul style="list-style-type: none"> – LAD – FBD – STL – SCL – CFC – GRAPH 	Yes Yes Yes Yes Yes Yes
Know-how protection	
<ul style="list-style-type: none"> User program protection/password protection Copy protection Block protection 	Yes Yes Yes
Access protection	
<ul style="list-style-type: none"> protection of confidential configuration data Password for display Protection level: Write protection Protection level: Read/write protection Protection level: Write protection for Failsafe Protection level: Complete protection User administration 	Yes Yes Yes Yes No Yes Yes

Article number	6ES7516-3AP03-0AB0
programming / cycle time monitoring / header	
<ul style="list-style-type: none"> • lower limit • upper limit 	<p>adjustable minimum cycle time</p> <p>adjustable maximum cycle time</p>
Dimensions	
Width	70 mm
Height	147 mm
Depth	129 mm
Weights	
Weight, approx.	469 g

General technical specifications

You can find information on the general technical specifications, such as standards and approvals, electromagnetic compatibility, protection class, etc., in the S7-1500, ET 200MP system manual (<http://support.automation.siemens.com/WW/view/en/59191792>).

Dimensional drawing

This section contains the dimensional drawing of the module on the mounting rail, as well as a dimensional drawing with the front panel open. Always observe the specified dimensions for installation in cabinets, control rooms, etc.

Dimensional drawings for CPU 1516-3 PN/DP

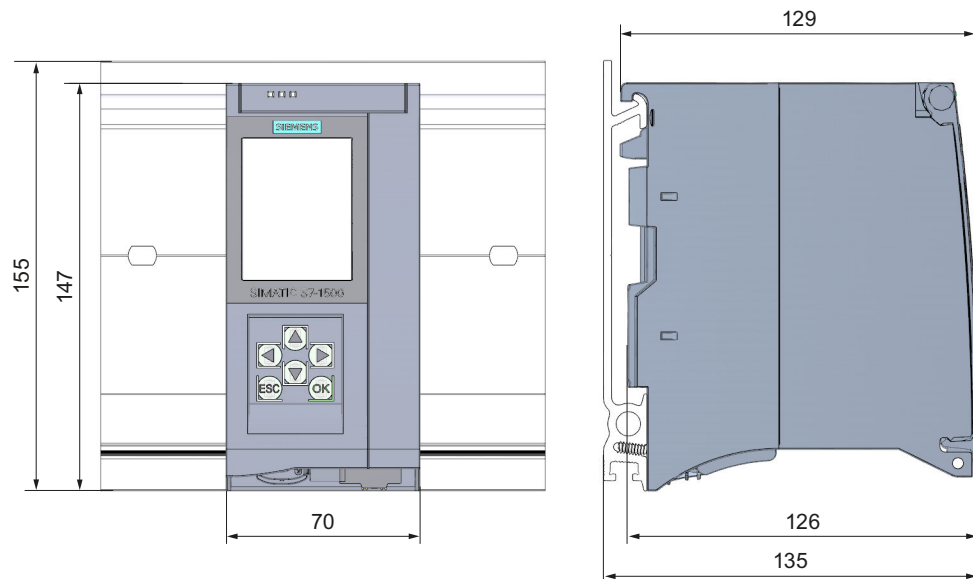

Figure A-1 Dimensional drawing of the CPU 1516-3 PN/DP

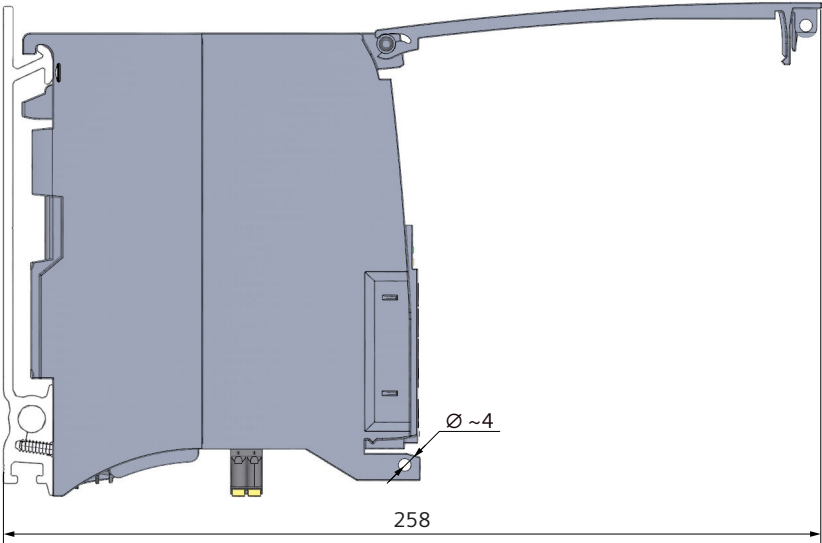

Figure A-2 CPU with open front panel