



0.4~22kW(200V/400V)

AC Variable Speed Drive

iG5A Troubleshooting Manual



Safety Instructions

Read this manual carefully before servicing or inspecting this equipment.

Keep this manual within easy reach for quick reference.

Quick Reference Table

The following table contains situations frequently encountered by users while working with inverters. Refer to the typical and practical situations in the table to quickly and easily locate answers to your questions.

Situation	Reference
The motor is too noisy.	P. 32
I want to review recent fault trip and warning histories.	P. 15
The motor runs too hot.	P. 29
The cooling fan does not work.	P. 33
I want to know how can I keep the inverter when I don't use it.	P. 44
ERR message is displaying on keypad.	P. 19
I want to initialize the parameter.	P. 13
I want to scrap the inverter.	P. 44
I want to review the input/output module.	P. 38
I want to change the FAN when it exceed replacement period	P. 42
I want to change the carrier frequency.	P. 12
I cannot set the parameter.	P. 28
The motor does not work.	P. 32
The motor stop when it accelerate the speed or connect the load.	P. 30

Contents



● INTRODUCTION	3
Manual Composition	3
● PRODUCT IDENTIFICATION	4
● ASSOCIATION MANUAL	4
● SAFETY INFORMATION	5
● REVISION RECORD	7

1 BASIC CHECKLIST 8

1.1 Before You Think It Is Failure	8
1.2 Basic Operations	10
1.3 Parameter Change	12
1.3.1 Carrier Frequency Change	12
1.3.2 Initializing All Parameters	13
1.3.3 Read and Write Parameters	14
1.4 Fault Trip Monitoring	15

2 TROUBLESHOOTING 18

2.1 Trips and Warnings	18
2.1.1 Fault/Warning List	19
2.1.2 Troubleshooting Fault Trips	21
2.2 Troubleshooting Other Faults	28

3 MAINTENANCE 34

3.1 Regular Inspection Lists	35
3.1.1 Daily Inspections	35
3.1.2 Annual inspections	36
3.1.3 Bi-annual Inspections	37
3.1.4 Checking the Input/Output Modules	38
3.1.5 Replacement of the cooling fan	42
3.2 Storage and disposal	44
3.2.1 Storage	44
3.2.2 Disposal	44

Introduction

Manual Composition

1 Basic Checklist

1.1 Before You Think It Is Failure

1.2 Basic Operations

1.3 Parameter Change

1.3.1 Carrier Frequency Change

1.3.2 Initializing All Parameters

1.3.3 Read and Write Parameters

1.4 Fault Trip Monitoring



When the problem of inverter occur, you can check the basic checklist before you think it is failure in these pages.

check the set-up of parameter using basic operations first and then check the trip record.

2 Troubleshooting



There are troubleshooting fault trips & other faults in these pages.

If problems are not resolved, please contact your vendor or LSIS.

2.1 Trips and Warnings

2.1.1 Fault/Warning List

2.1.2 Troubleshooting Fault Trips

2.2 Troubleshooting Other Faults

3 Maintenance

3.1 Regular Inspection Lists

3.1.1 Daily Inspections

3.1.2 Annual inspections

3.1.3 Bi-annual Inspections

3.1.4 Checking the Input/Output Modules

3.1.5 Replacement of the cooling fan

3.2 Storage and disposal

3.2.1 Storage

3.2.2 Disposal

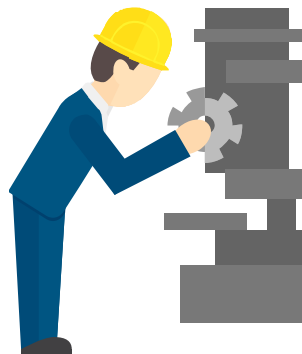

There are the regular inspection lists in these pages.

When the problem of inverter occur, please check the input/output module that is basic hardware check method.

Product Identification

Model name SV055iG5A-2

Power source specifications
 INPUT 200-230 V 3 Phase
 35.0A 50/60Hz

Output specifications
 OUTPUT 0-Input V 3 Phase
 24A 0.1 - 400Hz

9.1kVA
 Ser. No 12030100001
 Inspected by K.D.Hong

CE

UL US LISTED IND. CONT. EQ. 8724

LSIS MADE IN KOREA

SV 055 iG5A - 2

Motor capacity

004-0.4kw	055-5.5kw
008-0.75kw	075-7.5kw
015-1.5kw	110-11.0kw
022-2.2kw	150-15.0kw
037-3.7kw	185-18.5kw
040-4.0kw	220-22.0kw

Series name

Input voltage

1- Single phase	200~230[V]
2- 3 phase	200~230[V]
4- 3 phase	200~230[V]

Association Manual

iG5A user manual can be download through the homepage of LSIS.

Link : <http://www.lsis.com/support/download/>

Safety Information

Read and follow all safety instructions in this manual precisely to avoid unsafe operating conditions, property damage, personal injury, or death.

Safety symbols in this manual

Danger

Indicates an imminently hazardous situation which, if not avoided, will result in severe injury or death.

Warning

Indicates a potentially hazardous situation which, if not avoided, could result in injury or death

Caution

Indicates a potentially hazardous situation that, if not avoided, could result in minor injury or property damage.

Safety information

Danger

- Do not open the cover of the equipment while it is on or operating. Likewise, do not operate the inverter while the cover is open. Exposure of high voltage terminals or charging area to the external environment may result in an electric shock. Do not remove any covers or touch the internal circuit boards (PCBs) or electrical contacts on the product when the power is on or during operation. Doing so may result in serious injury, death, or serious property damage.
- Do not open the cover of the equipment even when the power supply to the inverter has been turned off unless it is necessary for maintenance or regular inspection. Opening the cover may result in an electric shock even when the power supply is off.
- The equipment may hold charge long after the power supply has been turned off. Use a multi-meter to make sure that there is no voltage before working on the inverter, motor or motor cable.

 **Warning**

- This equipment must be grounded for safe and proper operation.
- Do not supply power to a faulty inverter. If you find that the inverter is faulty, disconnect the power supply and have the inverter professionally repaired.
- The inverter becomes hot during operation. Avoid touching the inverter until it has cooled to avoid burns.
- Do not allow foreign objects, such as screws, metal chips, debris, water, or oil to get inside the inverter. Allowing foreign objects inside the inverter may cause the inverter to malfunction or result in a fire.
- Do not operate the inverter with wet hands. Doing so may result in electric shock.

 **Caution**

- Do not modify the interior workings of the inverter. Doing so will void the warranty.
- The inverter is designed for 3-phase motor operation. Do not use the inverter to operate a single phase motor.
- Do not place heavy objects on top of electric cables. Doing so may damage the cable and result in an electric shock.

Revision Record

Version	Date	Changed main contents	Association page
V1.0	2015.03	First edition	-

1 Basic Checklist

1.1 Before You Think It Is Failure

Items	Check Point	Result
Installation Location/ Input/Output voltage	Is the installation location appropriate?	
	Does the environment meet the inverter's operating conditions?	
	Does the power source match the inverter's rated input?	
	Is the inverter's rated output sufficient to supply the equipment?	
Power Terminal Wiring	Is a circuit breaker installed on the input side of the inverter?	
	Is the circuit breaker correctly rated?	
	Are the power source cables correctly connected to the R/S/T terminals of the inverter? (Caution: connecting the power source to the U/V/W terminals may damage the inverter.)	
	Are the motor output cables connected in the correct phase rotation (U/V/W)? (Caution: motors will rotate in reverse direction if three phase cables are not wired in the correct rotation.)	
	Are the cables used in the power terminal connections correctly rated?	
	Is the inverter grounded correctly?	
	Are the power terminal screws and the ground terminal screws tightened to their specified torques?	
	Are the overload protection circuits installed correctly on the motors (if multiple motors are run using one inverter)?	
	Is the inverter separated from the power source by a magnetic contactor (if a braking resistor is in use)?	
Are advanced-phase capacitors, surge protection and electromagnetic interference filters installed correctly? (These devices MUST not be installed on the output side of the inverter.)		

Items	Check Point	Result
Control Terminal Wiring	Are STP (shielded twisted pair) cables used for control terminal wiring?	
	Is the shielding of the STP wiring properly grounded?	
	If 3-wire operation is required, are the multi-function input terminals defined prior to the installation of the control wiring connections?	
	Are the control cables properly wired?	
	Are the control terminal screws tightened to their specified torques?	
	Is the total cable length of all control wiring < 165ft (50m)?	
	Is the total length of safety wiring < 100ft (30m)?	
Miscellaneous	Are optional cards connected correctly?	
	Is there any debris left inside the inverter?	
	Are any cables contacting adjacent terminals, creating a potential short circuit risk?	
	Are the control terminal connections separated from the power terminal connections?	
	Have the capacitors been replaced if they have been in use for > 2 years?	
	Has a fuse been installed for the power source?	
	Are the connections to the motor separated from other connections?	

1.2 Basic Operations

■ About the keypad

The keypad is composed of two main components – the display and the operation (input) keys. Refer to the following illustration to identify part names and functions

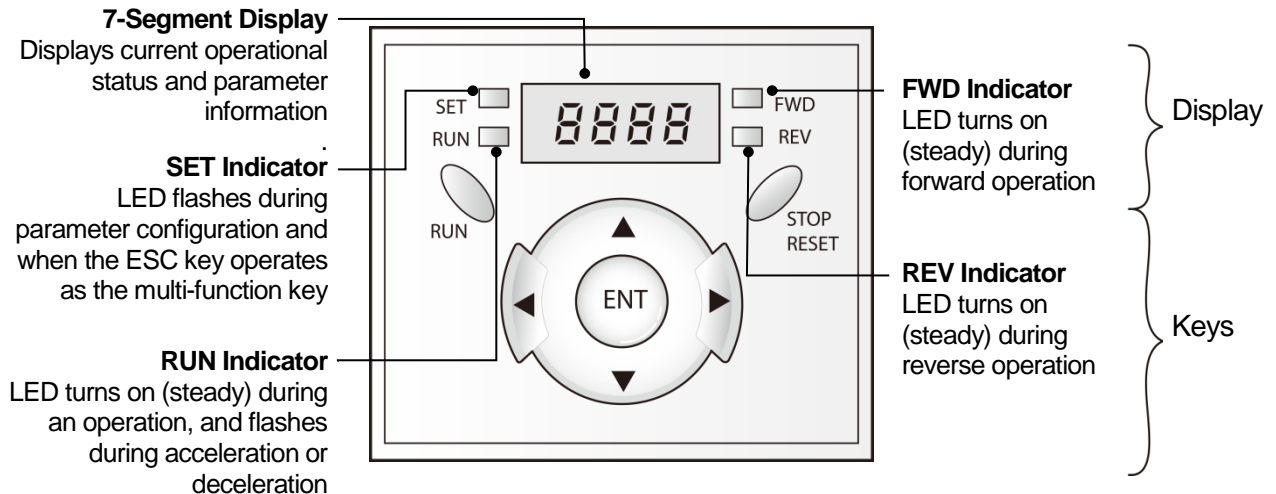



The table below lists the way that the keypad displays characters (letters and numbers).

0	0	A	A	K	U	U
1	1	b	B	L	L	V
2	2	c	C	m	M	W
3	3	d	D	n	N	X
4	4	E	E	O	O	Y
5	5	F	F	P	P	Z
6	6	G	G	Q	Q	
7	7	H	H	R	R	
8	8	I	I	S	S	
9	9	J	J	T	T	

■ Operation Keys

The following table lists the names and functions of the keypad's operation keys.

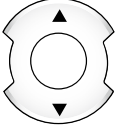
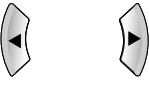
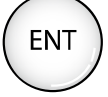
Key	Name	Description
	[RUN] Key	Used to run the inverter (inputs a RUN command).
	[STOP/RESET] Key	STOP: stops the inverter. RESET: resets the inverter following fault or failure condition.
	[▲] Key, [▼] Key	Switch between codes, or to increase or decrease parameter values.
	[◀] Key, [▶] Key	Switch between groups, or to move the cursor during parameter setup or modification.
	[ENT] Key	Used to select, confirm, or save a parameter value.

⚠ Caution

Install a separate emergency stop switch in the circuit. The [STOP/RESET] key on the keypad works only when the inverter has been configured to accept an input from the keypad.

1.3 Parameter Change

1.3.1 Carrier Frequency Change

The following example demonstrates how to configure Carrier Frequency by modifying code H39(Carrier Frequency) in the Function group 2 from 5.00(Hz) to 10.00(Hz). You can configure the parameters for different codes in any other group in exactly the same way.

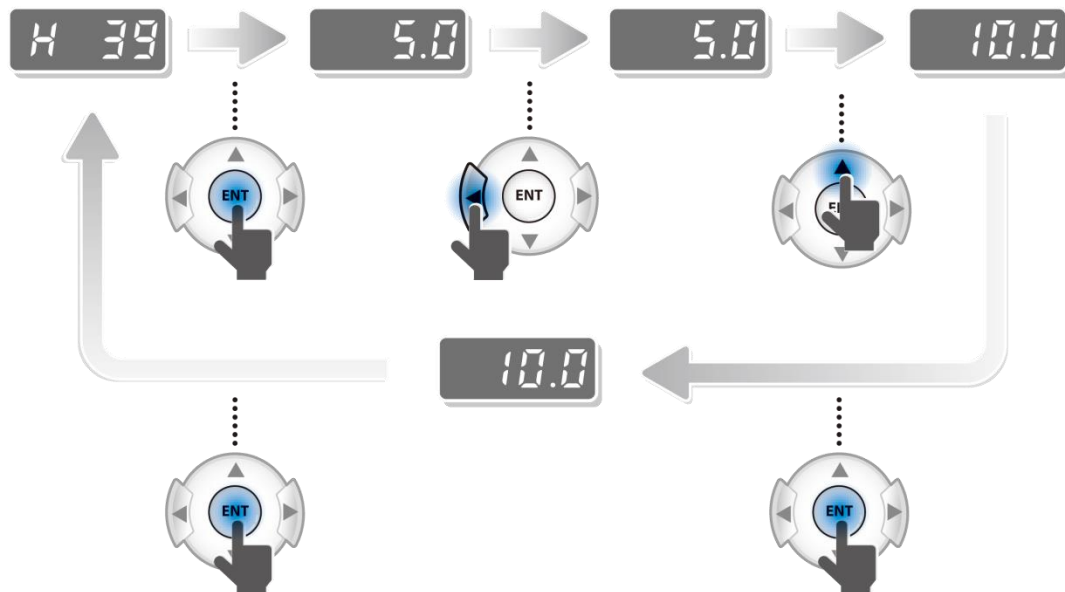

Step	Instruction	Keypad Display
1	Go to code H39(Carrier Frequency) in the Function group 2.	
2	Press the [ENT] key. The current Carrier Frequency value (5.00) for code H39 is displayed.	
3	Press the [◀] key 2 times to move to the 1s place value. Number '5' at the 1s place position will flash.	
4	Press the [▲] key to change the value to '0' to match the 1s place value of the target value '10.00', Press the [◀] key to change the value to '1' to match the 10s place value of the target value '10.00', and then press the [ENT] key. All parameter digits will flash on the display.	
5	Press the [ENT] key once again to save the changes. Code H39 will be displayed. The parameter change has been completed.	

Step	Instruction	Keypad Display
4	Press the [◀] key to move to the 10s place position.	
5	Press the [▲] or [▼] key to change the '0' to '9' of the target code, '93.'	
6	Press the [ENT] key. Code H 93 will be displayed.	
7	Press the [ENT] key once again. The current parameter value for code H93 is set to 0 (Do not initialize).	
8	Press the [▲] key to change the value to 1 (All Grp), and then press the [ENT] key. The parameter value will flash.	
9	Press the [ENT] key once again. Parameter initialization begins. Parameter initialization is complete when code H93 reappears on the display.	

Note

Following parameter initialization, all parameters are reset to factory default values. Ensure that parameters are reconfigured before running the inverter again after an initialization.

1.3.3 Read and Write Parameters

Group	Display	Parameter Name	Setting	Range	Default	Unit
Function group 2	H91	Parameter read	1	0~1	0	-
	H92	Parameter write	1	0~1	0	-

Read and Write Setting Details

Code	Description
H91 Parameter Read	Copies saved parameters from the inverter to the keypad. Saved parameters on the keypad will be deleted and replaced with copied parameters.
H92 Parameter Write	Take caution when Parameter write (H92) is executed. By doing this, parameters in inverter are cleared and parameters in remote keypad are copied to inverter.

* Available on LCD keypad only.

1.4 Fault Trip Monitoring

The following example demonstrates how to monitor fault trip conditions in the Operation group using the keypad.

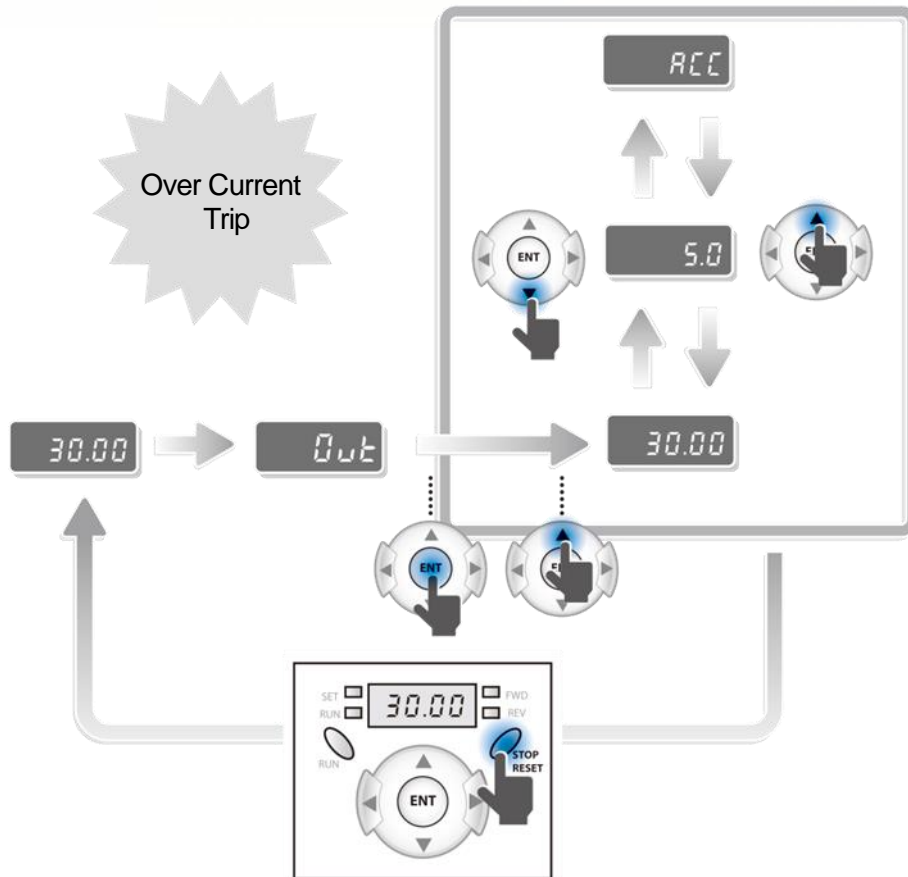

Step	Instruction	Keypad Display
1	Refer to the example keypad display. An over current trip fault has occurred.	
2	Press the [ENT] key, and then the [▲] key. The operation frequency at the time of the fault (30.00Hz) is displayed.	
3	Press the [▲] key. The output current at the time of the fault (5.0A) is displayed.	
4	Press the [▲] key. The operation status at the time of the fault is displayed. ACC on the display indicates that the fault occurred during acceleration.	
5	Press the [STOP/RESET] key. The inverter resets and the fault condition is cleared. The frequency reference is displayed on the keypad.	

The following example demonstrates how to monitor fault trip record.

Group	Display	Parameter Name	Setting	Range	Default	Unit
Function group 2	H 1	[Fault history 1]	-			
	~					
	H 5	[Fault history 5]	-			
	H 6	[Reset fault history]	-	0 ~ 1	0	

Up to 5 faults information is stored. a maximum of 5 fault trip records can be retrieved as shown in the following example.

■ Record of fault types

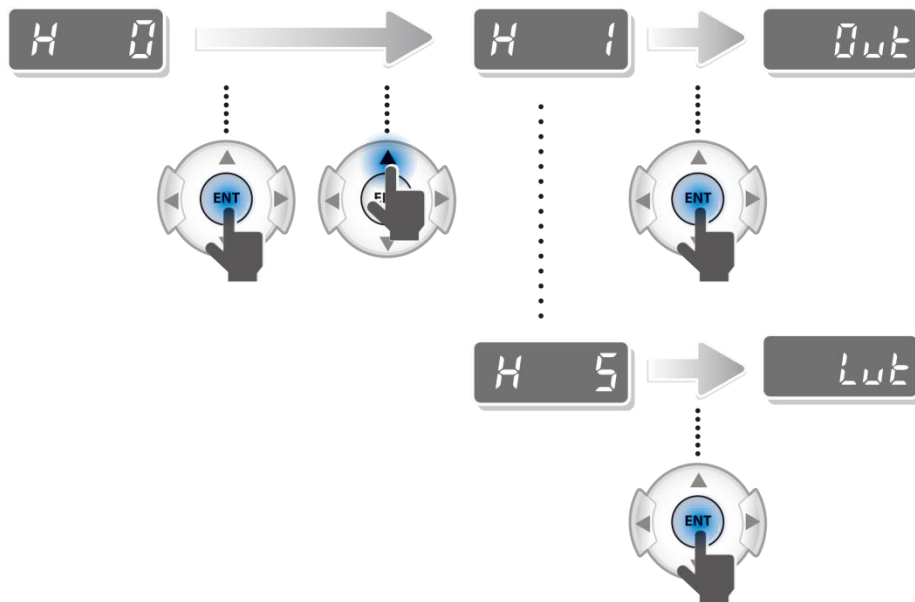

■ Operating status at fault

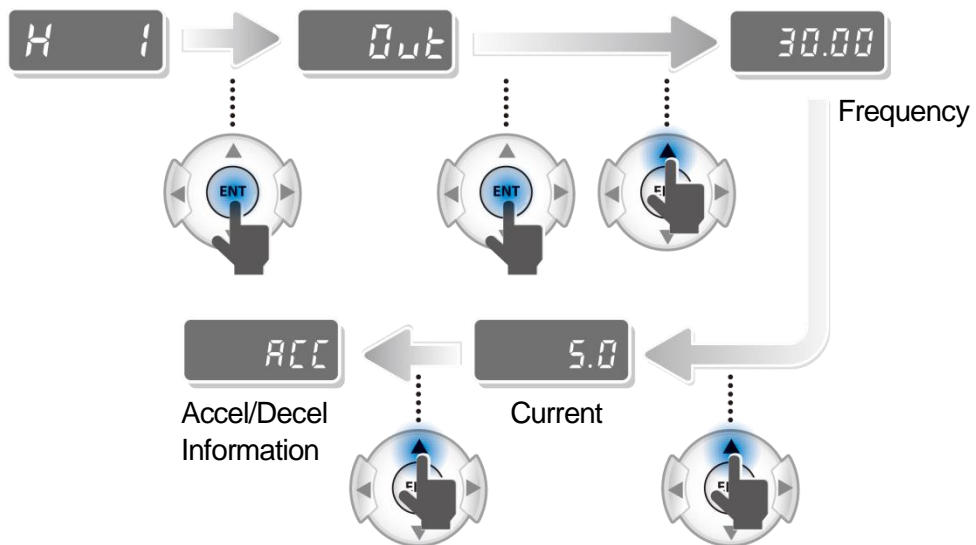

Fault types	Frequency		
	Current		
	Accel/Decel Information		Fault during Accel
			Fault during Decel
			Fault during constant run

■ Reset fault record

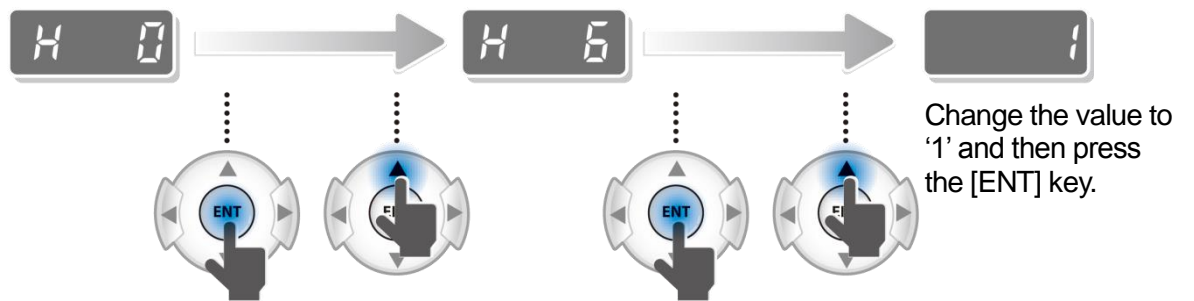

2 Troubleshooting

This chapter explains how to troubleshoot a problem when inverter protective functions, fault trips, warning signals, or a fault occurs. If the inverter does not work normally after following the suggested troubleshooting steps, please contact the LSIS customer service center.

2.1 Trips and Warnings



















When the inverter detects a fault, it stops the operation (trips) or sends out a warning signal. When a trip or warning occurs, the keypad displays the information briefly. If the LCD keypad is used, detailed information is shown on the LCD display. Users can read trip message when a fault occurs during operation in nOn code of drive group. Up to 5 trips information is stored.





The fault conditions can be categorized as follows:

- Level: When the fault is corrected, the trip or warning signal disappears and the fault is not saved in the fault history.
- Latch: When the fault is corrected and a reset input signal is provided, the trip or warning signal disappears.
- Fatal: When the fault is corrected, the fault trip or warning signal disappears only after the user turns off the inverter, waits until the charge indicator light goes off, and turns the inverter on again (If the inverter is still in a fault condition after powering it on again, please contact the supplier or the LSIS customer service center).

2.1.1 Fault/Warning List

The following list shows the types of faults and warnings that can occur while using the iG5A inverter.

Category	LCD Display	Details	Page	
Major fault	Latch type		Over current trip	P. 21
			ARM short current fault trip	P. 22
			Ground fault trip	P. 22
			Inverter overload fault trip	P. 23
			Overload fault trip	P. 23
			Over heat fault trip	P. 23
			Output open-phase fault trip	P. 24
			Over voltage trip	P. 24
			Electronic thermal	P. 25
			Input phase loss	-
			Self-diagnostic malfunction	-
			Parameter save error	P. 27
			Communication Error	P. 27
			Remote keypad communication error	P. 26
			Keypad error	P. 27
			Cooling fan fault	P. 24
			External fault A contact input	P. 26
			External fault B contact input	P. 26
	NTC Open	P. 27		

Category		LCD Display	Details	Page
			Brake control error	P. 27
	Level type		Operating method when the frequency command is lost	P. 26
			Low voltage fault trip	P. 25
			Instant cut off	-
	Fatal type		Hardware fault	P. 27
Warning		Over Load	Over load warning	-

* Overload Protection

IOLT : IOLT(inverter Overload Trip) protection is activated at 150% of the inverter rated current for 1 minute and greater.

OLT : OLT is selected when F56 is set to 1 and activated at 200% of F57[Motor rated current] for 60 sec in F58. This can be programmable.

iG5A is not provided with “Over speed Protection.”



2.1.2 Troubleshooting Fault Trips

When a fault trip or warning occurs due to a protection function, refer to the following table for possible causes and remedies.

LCD Display		Type	Description
	Over Current	Latch	Displayed when inverter output current exceeds 200% of the rated current.
Cause		Remedy	
Acc/Dec time is too short, compared to load inertia (GD2).		Increase Acc/Dec time.	
The inverter load is greater than the rated capacity.		Replace the inverter with a model that has increased capacity.	
The inverter supplied an output while the motor was idling.		Operate the inverter after the motor has stopped or use the speed search function (Cn.60).	
The mechanical brake of the motor is operating too fast.		Check the mechanical brake.	
Output wiring is short-circuited or a ground fault has occurred.		Remove a short circuit and ground fault and check the motor	
There is a inverter-motor connection problem.		Check the output wiring Ensure that the total cable length between the inverter and the motor is less than 200m (50m for motors rated 3.7 kW or lower).	
There is a fault with the output module (IGBT).		Refer to 3.1.4 Checking the Input/Output Modules on page38 and check a fault with the output module(IGBT) Do not operate the inverter. Contact the retailer or the LSIS customer service center.	

LCD Display		Type	Description
	Over Current2	Latch	Displayed when the DC circuit in the inverter detects a specified level of excessive, short circuit current..
Cause		Remedy	
Acc/Dec time is too short, compared to load inertia (GD2).		Increase Acc/Dec time.	
Output wiring is short-circuited.		Check the output wiring.	
There is a inverter-motor connection problem.		Check the output wiring Ensure that the total cable length between the inverter and the motor is less than 200m (50m for motors rated 3.7 kW or lower).	
There is a fault with the output module (IGBT).		Refer to 3.1.4 Checking the Input/Output Modules on page38 and check a fault with the output module(IGBT) Do not operate the inverter. Contact the retailer or the LSIS customer service center.	

LCD Display		Type	Description
	Ground fault Trip	Latch	The inverter turns off its output when a ground fault occurs and the ground fault current is more than the internal setting value of the inverter.
Cause		Remedy	
A ground fault has occurred in the inverter output wiring.		Check the output wiring.	
There is a inverter-motor connection problem.		Check the output wiring Ensure that the total cable length between the inverter and the motor is less than 200m (50m for motors rated 3.7 kW or lower).	
The motor insulation is damaged.		Replace the motor.	
Noise occurs in the peripherals		Change the carrier frequency to the minimum value in H39	

LCD Display		Type	Description
	Inverter Overload	Latch	The inverter turns off its output when the output current of the inverter flows more than the rated level (150% for 1 minute).
	Overload trip	Latch	The inverter turns off its output if the output current of the inverter flows at 150% of the inverter rated current for more than the current limit time (1 min).
Cause		Remedy	
The load is greater than the motor's rated capacity.		Ensure that the motor and inverter have appropriate capacity ratings.	
There is a fault with the output module (IGBT).		Refer to 3.1.4 Checking the Input/Output Modules on page38 and check a fault with the output module(IGBT) Do not operate the inverter. Contact the retailer or the LSIS customer service center.	
The load is greater than the rated motor capacity.		Replace the motor and inverter with models that have increased capacity.	
The torque boost level is too high.		Reduce the torque boost level.	
Acc/Dec time is too short, compared to load inertia (GD2).		Increase Acc/Dec time.	

LCD Display		Type	Description
	Over Heat Trip	Latch	Displayed when the temperature of the inverter heat sink exceeds the specified value.
Cause		Remedy	
There is a problem with the cooling system.		Determine if a foreign object is obstructing the air inlet, outlet, or vent.	
The inverter cooling fan has been operated for an extended period.		Replace the cooling fan (Refer to 3.1.3 Replacement of the cooling fan)	
The ambient temperature is too high.		Keep the ambient temperature below 50 °C.	



LCD Display		Type	Description
	Output Phase Open	Latch	Displayed when a 3-phase inverter output has one or more phases in an open circuit condition.
Cause		Remedy	
The magnetic contactor on the output side has a connection fault.		Check the magnetic contactor on the output side.	
The output wiring is faulty.		Check the output wiring.	

LCD Display		Type	Description
	Cooling Fan Trip	Latch	Displayed when a fault condition occurs in the inverter cooling fan..
Cause		Remedy	
A foreign object is obstructing the fan's air vent.		Remove the foreign object from the air inlet or outlet.	
The cooling fan needs to be replaced.		Replace the cooling fan. (Refer to 3.1.3 Replacement of the cooling fan)	

LCD Display		Type	Description
	Over Voltage Trip	Latch	The inverter turns off its output if the DC voltage of the main circuit increases higher than 400 V when the motor decelerates. This fault can also occur due to a surge voltage generated at the power supply system.
Cause		Remedy	
The input voltage is too high.		Determine if the input voltage is above the specified value.	
The actual DC link voltage is different from the displayed value..		Need to inspect hardware. Contact the retailer or the LSIS customer service center.	
Deceleration time is too short for the load inertia (GD2).		Increase the acceleration time.	
A generative load occurs at the inverter output.		Use the braking unit.	

LCD Display		Type	Description
	Low Voltage Trip	Level	Displayed when internal DC circuit voltage is less than the specified value.
Cause		Remedy	
The input voltage is too low.		Determine if the input voltage is below the specified value.	
The actual DC link voltage is different from the displayed value..		Need to inspect hardware. Contact the retailer or the LSIS customer service center.	
Blackout accidents occur		Use speed search function	
An input phase-loss has occurred.		Check the input wiring.	
The magnetic contactor connected to the power source has a faulty connection.		Replace the magnetic contactor.	
A load greater than the power capacity is connected to the system (e.g., a welder, direct motor connection, etc.)		Increase the power capacity.	



LCD Display		Type	Description
	Electronic Thermal	Latch	Displayed based on inverse time-limit thermal characteristics to prevent motor overheating.
Cause		Remedy	
The motor has overheated.		Reduce the load or operation frequency.	
The inverter load is greater than the rated capacity.		Replace the inverter with a model that has increased capacity.	
The set value for electronic thermal protection(ETH) is too low.		Set an appropriate electronic thermal level(ETH).	
The inverter has been operated at low speed for an extended duration.		Replace the motor with a model that supplies extra power to the cooling fan.	

LCD Display		Type	Description
	External fault A contact input	Latch	Normal open contact input. When a P7 terminal set to “Ext trip-A” is ON (Closed), inverter displays the fault and turns off its output.
	External fault B contact input	Latch	Normal close contact input. When a P8 terminal set to “Ext trip-B” is OFF (Open), inverter displays the fault and turns off its output.
Cause		Remedy	
The terminal set to “18 (External fault-A)” or “19 (External fault-B)” in I20-I24 in I/O group is ON.		Eliminate the cause of fault at circuit connected to external fault terminal or cause of external fault input.	

LCD Display		Type	Description
	No frequency command	Level	When inverter operation is set via Analog input (0-10V or 0-20mA input) or option (RS485) and no signal is applied, operation is done according to the method set in I62 (Operating method when the frequency reference is lost).
Cause		Remedy	
No frequency command is applied to V1 and I.		Check the wiring of V1 and I and frequency reference level.	

LCD Display		Type	Description
	Remote keypad communication error	Latch	Displayed when inverter and remote keypad does not communicate each other. It does not stop Inverter operation.
Cause		Remedy	
Communication error between inverter keypad and remote keypad.		Check for connection of communication line and connector.	

LCD Display		Type	Description
	Brake control error	Latch	When Break control, if rating current flows below than set value, cut off the output without break open.
Cause		Remedy	
Break open current is not flow any more		Check the Motor Capacity & Wiring	

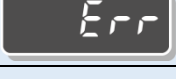
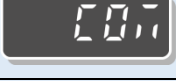
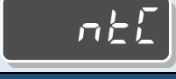
LCD Display		Type	Description
	Parameter save error	Latch	Displayed when user-setting parameters fails to be entered into memory.
	Hardware fault	Fatal	Displayed when an error occurs in the control circuitry of the inverter.
	Communication error	Latch	Displayed when the inverter cannot communicate with the keypad.
	Keypad error	Latch	Displayed after Inverter resets keypad when keypad error occurs and this status is maintained for a certain time.
	NTC error	Latch	When NTC is not connected, outputs are cut off.
Cause		Remedy	
Need to inspect hardware.		Contact the retailer or the LSIS customer service center.	

2.2 Troubleshooting Other Faults

When a fault other than those identified as fault trips or warnings occurs, refer to the following table for possible causes and remedies.

Parameters cannot be set.

Cause	Remedy
The inverter is in operation (driving mode).	Stop the inverter to change to program mode and set the parameter.
The parameter access is incorrect.	Check the correct parameter access level and set the parameter.
The password is incorrect.	Check the password, disable the parameter lock by setting UL(Unlock) in H95 and set the parameter.
Low voltage is detected.	Check the power input to resolve the low voltage and set the parameter.

The motor does not rotate.

Cause	Remedy
The frequency command source is set incorrectly.	Check the frequency command source setting.
The operation command source is set incorrectly.	Check the operation command source setting.
Power is not supplied to the terminal R/S/T.	Check the terminal connections R/S/T and U/V/W.
The charge lamp is turned off.	Turn on the inverter.
The operation command is off.	Turn on the operation command (RUN).
The motor is locked.	Unlock the motor or lower the load level.
The load is too high.	Operate the motor independently.
An emergency stop signal is input.	Reset the emergency stop signal.
The wiring for the control circuit terminal is incorrect.	Check the wiring for the control circuit terminal.
The input option for the frequency command is incorrect.	Check the input option for the frequency command.
The input voltage or current for the frequency command is incorrect.	Check the input voltage or current for the frequency command.
The PNP/NPN mode is selected incorrectly.	Check the PNP/NPN mode setting.
The frequency command value is too low.	Check the frequency command and input a value above the minimum frequency.
The [STOP/RESET] key is pressed.	Check that the stoppage is normal, if so resume operation normally.
Motor torque is too low.	Change the operation modes (V/F, IM, and Sensorless). If

	the fault remains, replace the inverter with a model with increased capacity.
--	---

The motor rotates in the opposite direction to the command.

Cause	Remedy
The wiring for the motor output cable is incorrect.	Determine if the cable on the output side is wired correctly to the phase (U/V/W) of the motor.
The signal connection between the control circuit terminal (forward/reverse rotation) of the inverter and the forward/reverse rotation signal on the control panel side is incorrect.	Check the forward/reverse rotation wiring.

The motor only rotates in one direction.

Cause	Remedy
Reverse rotation prevention is selected.	Remove the reverse rotation prevention.
The reverse rotation signal is not provided, even when a 3-wire sequence is selected.	Check the input signal associated with the 3-wire operation and adjust as necessary.

The motor is overheating

Cause	Remedy
The load is too heavy.	Reduce the load. Increase the Acc/Dec time.
	Check the motor parameters and set the correct values.
	Replace the motor and the inverter with models with appropriate capacity for the load.
The ambient temperature of the motor is too high.	Lower the ambient temperature of the motor.
The phase-to-phase voltage of the motor is insufficient.	Use a motor that can withstand phase-to-phase voltages surges greater than the maximum surge voltage.
	Only use motors suitable for applications with inverters.
	Connect the AC reactor to the inverter output (set the carrier frequency to 2 kHz in H39).
The motor fan has stopped or the fan is obstructed with debris.	Check the motor fan and remove any foreign objects.

The motor stops during acceleration or when connected to load.

Cause	Remedy
The load is too high.	Reduce the load.
	Replace the motor and the inverter with models with capacity appropriate for the load.

The motor does not accelerate. /The acceleration time is too long

Cause	Remedy
The frequency command value is low.	Set an appropriate value.
The load is too high.	Reduce the load and increase the acceleration time. Check the mechanical brake status.
The acceleration time is too long.	Change the acceleration time.
The combined values of the motor properties and the inverter parameter are incorrect.	Change the motor related parameters.
The stall prevention level during acceleration is low.	Change the stall prevention level.
The stall prevention level during operation is low.	Change the stall prevention level.
Starting torque is insufficient.	Change to vector control operation mode. If the fault is still not corrected, replace the inverter with a model with increased capacity.

Motor speed varies during operation.

Cause	Remedy
There is a high variance in load.	Replace the motor and inverter with models with increased capacity.
The input voltage varies.	Reduce input voltage variation.
Motor speed variations occur at a specific frequency.	Adjust the output frequency to avoid a resonance area.

The motor rotation is different from the setting.

Cause	Remedy
The V/F pattern is set incorrectly.	Set a V/F pattern that is suitable for the motor specification.

The motor deceleration time is too long even with Dynamic Braking (DB) resistor connected.

Cause	Remedy
The deceleration time is set too long.	Change the setting accordingly.
The motor torque is insufficient.	If motor parameters are normal, it is likely to be a motor capacity fault. Replace the motor with a model with increased capacity.
The load is higher than the internal torque limit determined by the rated current of the inverter.	Replace the inverter with a model with increased capacity.

Operation is difficult in under load applications.

Cause	Remedy
The carrier frequency is too high.	Reduce the carrier frequency.
Over-excitation has occurred due to an inaccurate V/F setting at low speed.	Reduce the torque boost value to avoid over-excitation.

While the inverter is in operation, a control unit malfunctions or noise occurs.

Cause	Remedy
Noise occurs due to switching inside the inverter.	Change the carrier frequency to the minimum value in H39
	Install a micro surge filter in the inverter output.

When the inverter is operating, the earth leakage breaker is activated.

Cause	Remedy
An earth leakage breaker will interrupt the supply if current flows to ground during inverter operation.	Connect the inverter to a ground terminal.
	Check that the ground resistance is less than 100Ω for 200V inverters and less than 10Ω for 400V inverters.
	Check the capacity of the earth leakage breaker and make the appropriate connection, based on the rated current of the inverter.
	Lower the carrier frequency in H39
	Make the cable length between the inverter and the motor as short as possible.

The motor vibrates severely and does not rotate normally.

Cause	Remedy
Phase-to-phase voltage of 3-phase power source is not balanced.	Check the input voltage and balance the voltage.
	Check and test the motor's insulation.

The motor makes humming, or loud noises.

Cause	Remedy
Resonance occurs between the motor's natural frequency and the carrier frequency.	Slightly increase or decrease the carrier frequency in H39
Resonance occurs between the motor's natural frequency and the inverter's output frequency.	Slightly increase or decrease the carrier frequency.
	Use the frequency jump function to avoid the frequency band where resonance occurs.

The motor vibrates/hunts.

Cause	Remedy
The frequency input command is an external, analog command.	In situations of noise inflow on the analog input side that results in command interference, change the input filter time constant (In.07, IN22)
The wiring length between the inverter and the motor is too long.	Ensure that the total cable length between the inverter and the motor is less than 200m (50m for motors rated 3.7 kW or lower).

The motor does not come to a complete stop when the inverter output stops.

Cause	Remedy
It is difficult to decelerate sufficiently, because DC braking is not operating normally.	Adjust the DC braking parameter.
	Increase the set value for the DC braking current.
	Increase the set value for the DC braking stopping time.

The output frequency does not increase to the frequency reference.

Cause	Remedy
The frequency reference is within the jump frequency range.	Set the frequency reference higher than the jump frequency range.
The frequency reference is exceeding the upper limit of the frequency command.	Set the upper limit of the frequency command higher than the frequency reference.
Because the load is too heavy, the stall prevention function is working.	Replace the inverter with a model with increased capacity.

The cooling fan does not rotate.

Cause	Remedy
The control parameter for the cooling fan is set incorrectly..	Check the control parameter setting for the cooling fan.

3 Maintenance

This chapter explains how to replace the cooling fan, the regular inspections to complete, and how to store and dispose of the product. An inverter is vulnerable to environmental conditions and faults also occur due to component wear and tear. To prevent breakdowns, please follow the maintenance recommendations in this section.

⚠ Caution

- Before you inspect the product, read all safety instructions contained in this manual.
- Before you clean the product, ensure that the power is off
- Clean the inverter with a dry cloth. Cleaning with wet cloths, water, solvents, or detergents may result in electric shock or damage to the product.

3.1 Regular Inspection Lists

3.1.1 Daily Inspections

Inspection method	Judgment standard	Inspection equipment	Inspection method	Judgment standard	Inspection equipment
All	Ambient environment	Is the ambient temperature and humidity within the design range, and is there any dust or foreign objects present?	Refer to 2. Installation & Wiring on User manual.	No icing (ambient temperature: -10 - +40) and no condensation (ambient humidity below 50%)	Thermometer, hygrometer, recorder
	Inverter	Is there any abnormal vibration or noise?	Visual inspection	No abnormality	
	Power voltage	Are the input and output voltages normal?	Measure voltages between R/ S/ T-phases in. the inverter terminal block.	Refer to 13.1 Technical data on User manual.	Digital multimeter tester
Input/Output circuit	Smoothing capacitor	Is there any leakage from the inside?	Visual inspection	No abnormality	-
		Is the capacitor swollen?			
Cooling system	Cooling fan	Is there any abnormal vibration or noise?	Turn off the system and check operation by rotating the fan manually.	Fan rotates smoothly	-
Display	Measuring device	Is the display value normal?	Check the display value on the panel.	Check and manage specified values.	Voltmeter, ammeter, etc.
Motor	All	Is there any abnormal vibration or noise?	Visual inspection	No abnormality	-
		Is there any abnormal smell?	Check for overheating or damage.		

3.1.2 Annual inspections

Inspection method	Judgment standard	Inspection equipment	Inspection method	Judgment standard	Inspection equipment
Input/Output circuit	All	Megger test (between input/output terminals and earth terminal)	Disconnect inverter and short R/S/T/U/V/W terminals, and then measure from each terminal to the ground terminal using a Megger.	Must be above 5 M Ω	DC 500 V Megger
		Is there anything loose in the device?	Tighten up all screws.	No abnormality	
		Is there any evidence of parts overheating?	Visual inspection		
	Cable connections	Are there any corroded cables?	Visual inspection	No abnormality	-
		Is there any damage to cable insulation?			
	Terminal block	Is there any damage?	Visual inspection	No abnormality	-
	Smoothing condenser	Measure electrostatic capacity.	Measure with capacity meter.	Rated capacity over 85%	Capacity meter
	Relay	Is there any chattering noise during operation?	Visual inspection	No abnormality	-
		Is there any damage to the contacts?	Visual inspection		
	Braking resistor	Is there any damage from resistance?	Visual inspection	No abnormality	Digital multimeter / analog tester
Check for disconnection.		Disconnect one side and measure with a tester.	Must be within $\pm 10\%$ of the rated value of the resistor.		
Control circuit Protection circuit	Operation check	Check for output voltage imbalance while the inverter is in operation.	Measure voltage between the inverter output terminal U/ V/ W.	Balance the voltage between phases: within 4V for 200V series and within 8V for 400V series.	Digital multimeter or DC voltmeter

Inspection method	Judgment standard	Inspection equipment	Inspection method	Judgment standard	Inspection equipment
		Is there an error in the display circuit after the sequence protection test?	Test the inverter output protection in both short and open circuit conditions.	The circuit must work according to the sequence.	
Cooling system	Cooling fan	Are any of the fan parts loose?	Check all connected parts and tighten all screws.	No abnormality	-
Display	Display device	Is the display value normal?	Check the command value on the display device.	Specified and managed values must match.	Voltmeter, Ammeter, etc.

3.1.3 Bi-annual Inspections

Inspection method	Judgment standard	Inspection equipment	Inspection method	Judgment standard	Inspection equipment
Motor	Insulation resistance	Megger test (between the input, output and earth terminals).	Disconnect the cables for terminals U/V/W and test the wiring.	Must be above 5 M Ω	DC 500 V Megger

⚠ Caution

Do not run an insulation resistance test (Megger) on the control circuit as it may result in damage to the product.

3.1.4 Checking the Input/Output Modules

How to check the diode module and IGBT module (SV004~075iG5A-2/4)

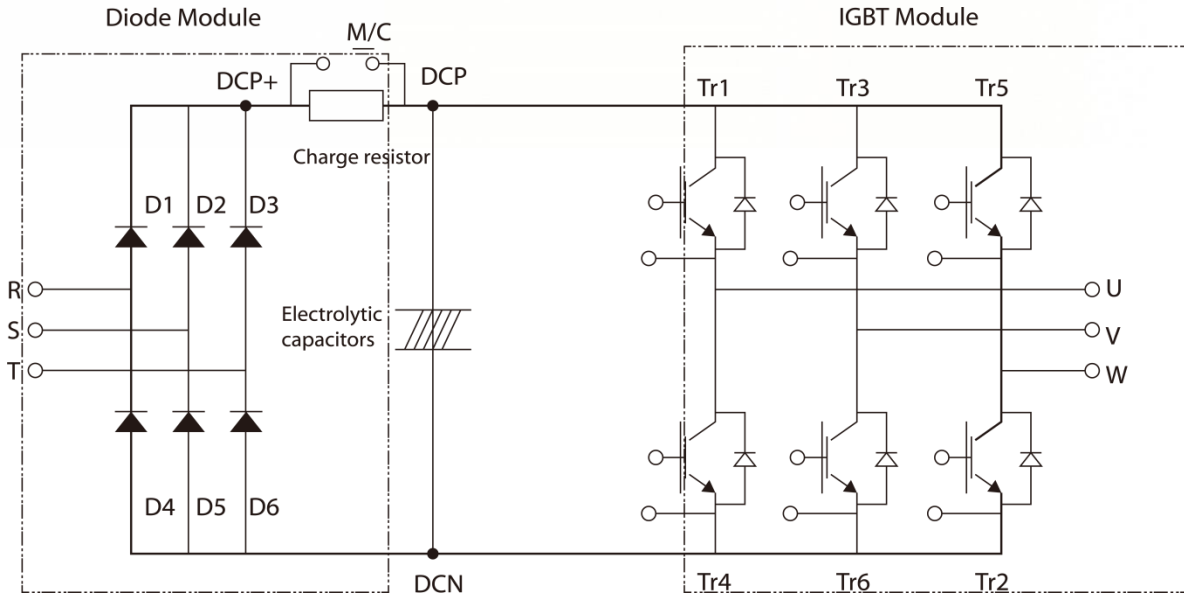

Testing method

- 1) Disconnect all power cables (R,S,T) and motor output cables (U,V,W)
- 2) Before testing, check the discharge of electrolytic capacitor (DCP-DCN)
- 3) When the circuit is open, the DMM indicates a high resistance (several MΩ). In some situations the DMM may indicate a closed circuit (low resistance) and then indicate a high resistance due to the capacitors. When the circuit is closed, the DMM indicates a resistance of several hundred kΩ or less.
- 4) Displayed values may not be constant as they depend on the module and tester type. However, the value measured between phases can be considered satisfactory if the measured value is within ±10%

Module		Test Polarity		Check Value	Module		Test Polarity		Check Value
		+	-				+	-	
Diode	D1	R	DCP+	Closed	D4	R	DCN	Open	
		DCP+	R	Open		DCN	R	Closed	
	D2	S	DCP+	Closed	D5	S	DCN	Open	
		DCP+	S	Open		DCN	S	Closed	
	D3	T	DCP+	Closed	D6	T	DCN	Open	
		DCP+	T	Open		DCN	T	Closed	
IGBT	Tr1	U	DCP	Closed	Tr4	U	DCN	Open	
		DCP	U	Open		DCN	U	Closed	
	Tr2	V	DCP	Closed	Tr6	V	DCN	Open	
		DCP	V	Open		DCN	V	Closed	
	Tr3	W	DCP	Closed	Tr2	W	DCN	Open	
		DCP	W	Open		DCN	W	Closed	

How to check the diode module and IGBT module (SV110~220iG5A-2/4)

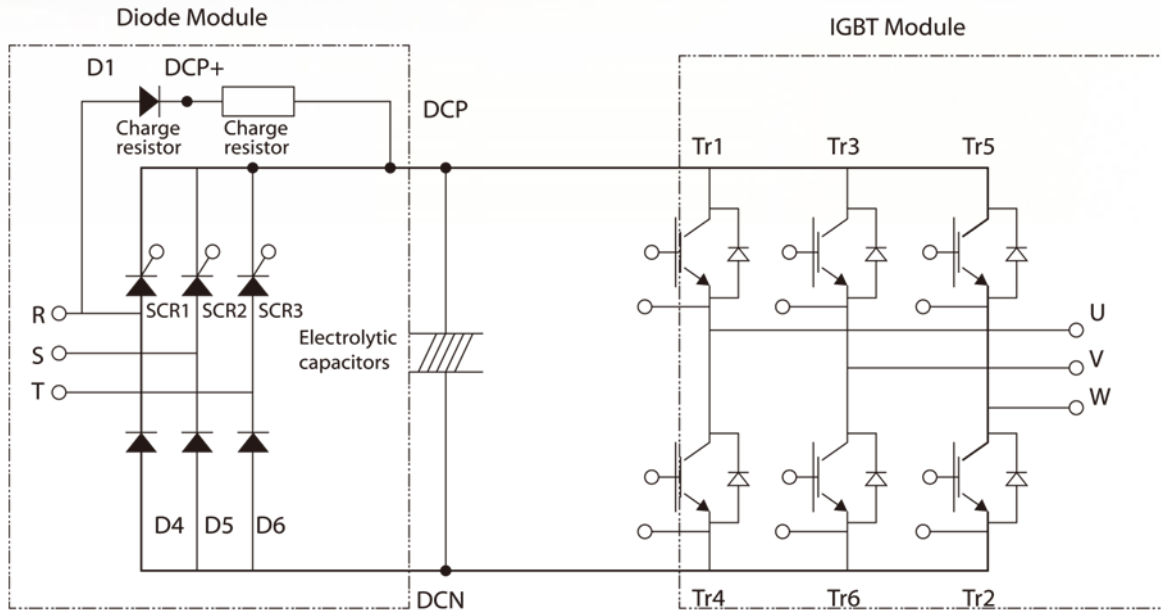

Testing method

- 1) Disconnect all power cables (R,S,T) and motor output cables (U,V,W)
- 2) Before testing , check the discharge of electrolytic capacitor (DCP-DCN)
- 3) When the circuit is open, the DMM indicates a high resistance (several MΩ). In some situations the DMM may indicate a closed circuit (low resistance) and then indicate a high resistance due to the capacitors. When the circuit is closed, the DMM indicates a resistance of several hundred kΩ or less.
- 4) Displayed values may not be constant as they depend on the module and tester type. However, the value measured between phases can be considered satisfactory if the measured value is within ±10%

Module		Test Polarity		Check Value	Module		Test Polarity		Check Value
		+	-				+	-	
Diode	D1	R	DCP+	Closed	D4	R	DCN	Open	
		DCP+	R	Open		DCN	R	Closed	
	D5	S	N	Open	D6	T	DCN	Open	
		N	S	Closed		DCN	T	Closed	
	IGBT	Tr1	U	DCP	Closed	Tr4	U	DCN	Open
			DCP	U	Open		DCN	U	Closed
Tr3		V	DCP	Closed	Tr6	V	DCN	Open	
		DCP	V	Open		DCN	V	Closed	
Tr5		W	DCP	Closed	Tr2	W	DCN	Open	
		DCP	W	Open		DCN	W	Closed	

■ Checking the diode module and IGBT module samples

Checking the Diode D2

- 1) Measure the resistance value of D2 by placing the red lead from positive terminal of DMM on S phase and placing black lead from negative terminal of DMM on DCP+
 - If the DMM indicates the resistance of several hundred $k\Omega$ or less, It is normal
- 2) Measure the resistance value of D2 by placing the red lead from positive terminal of DMM on DCP+ and placing black lead from negative terminal of DMM on S phase
 - If the DMM indicates the high resistance (several $M\Omega$), It is normal.
- 3) In the same way, Measure the resistance values of other diodes

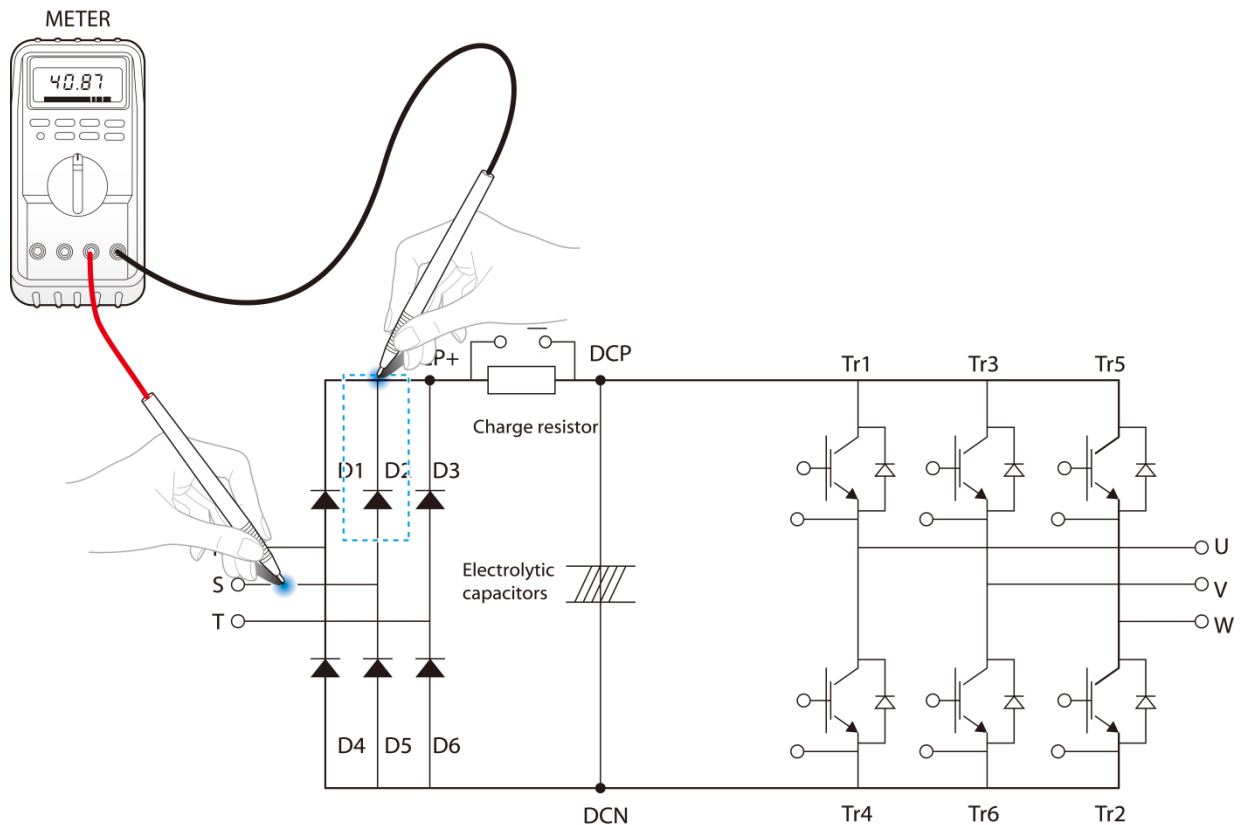

⚠ Caution

Before testing , check the discharge of electrolytic capacitor (DCP-DCN)

Checking the IGBT Tr6

- 1) Measure the resistance value of Tr6 by placing the red lead from positive terminal of DMM on DCN and placing black lead from negative terminal of DMM on V phase
 - If the DMM indicates the resistance of several hundred kΩ or less, It is normal
- 2) Measure the resistance value of Tr6 by placing the red lead from positive terminal of DMM on V phase and placing black lead from negative terminal of DMM on DCN
 - If the DMM indicates the high resistance (several MΩ), It is normal.
- 3) In the same way, Measure the resistance values of other IGBTs

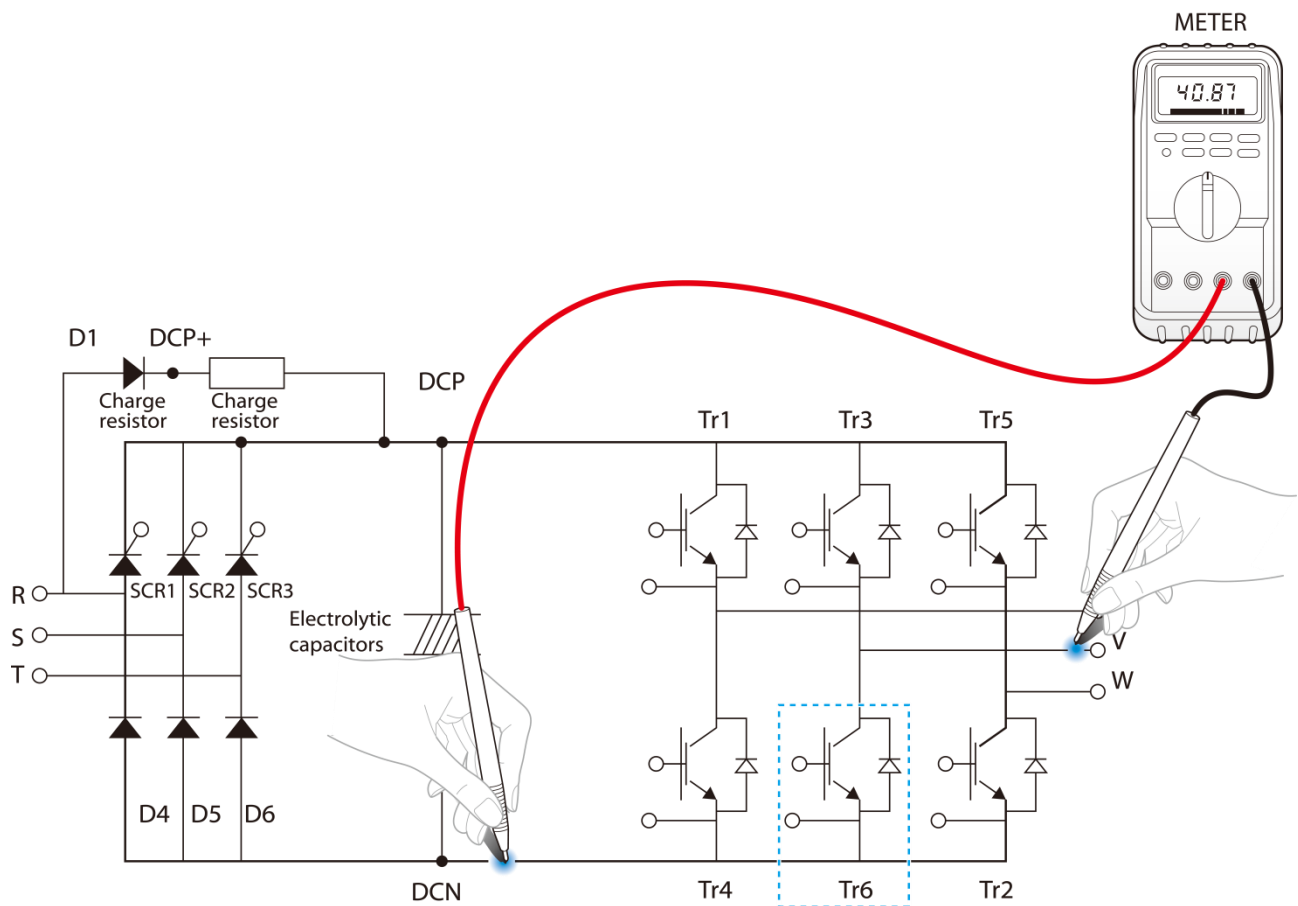

⚠ Caution

Before testing , check the discharge of electrolytic capacitor (DCP-DCN)

3.1.5 Replacement of the cooling fan

If operation is continued after cooling fan trip occurs, Overheat trip may happen and protective function be activated. It also reduces the life of main components due to rise in inverter inner temperature.

When the fan has been operated for an extended duration, the inverter can be damaged or their lifecycle reduced. Standard replacement interval of the cooling fan is 3years. Replace the old cooling fan with a new one periodically.

Methods of replacement of the cooling fan can be categorized as following frames:

Frame	Capacity
A Frame	SV004~008iG5A-2/4
B Frame	SV015iG5A-2/4
C Frame	SV022~040iG5A-2/4
D Frame	SV055~075iG5A-2/4
E Frame	SV110~150iG5A-2/4
F Frame	SV185~220iG5A-2/4

Replacement of the A ~C Frame FAN (SV004~040iG5A-2/4)

- 1) Remove the fan cover by holding hooks of the fan cover.

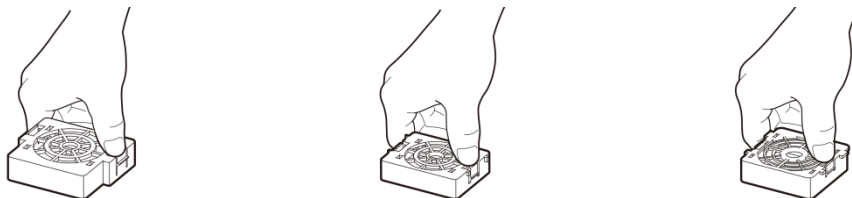

- 2) Disconnect the fan wire and remove the fan.

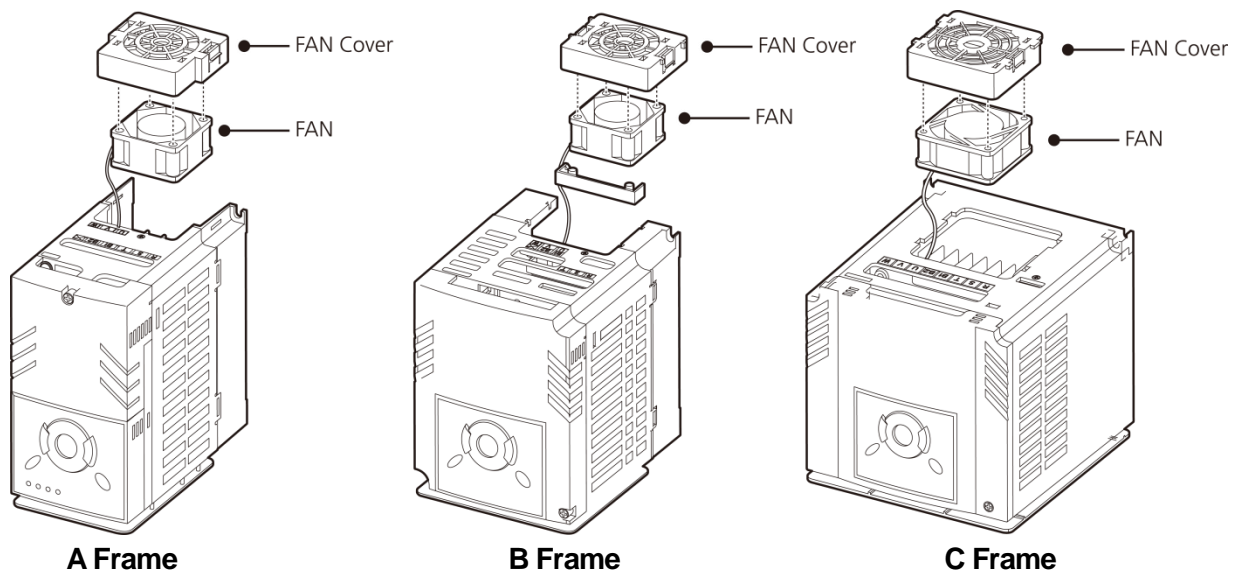

Replacement of D Frame FAN (SV055~075iG5A-2/4)

- 1) Remove the fan cover by holding hooks of the fan cover.

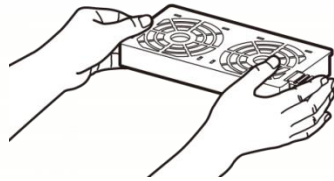

- 2) Disconnect the fan wire and remove the fan.

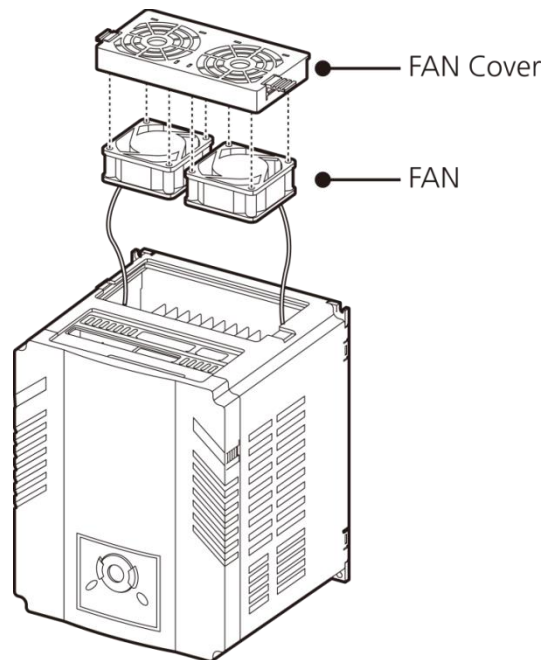

D Frame

For replacement of E, F Frame FAN, Contact the retailer or the LSIS customer service center

⚠ Caution

- Before replacing the Fan, Turn off the power supply and ensure all DC voltage has been fully discharged for about 1~3 minutes
- Be careful not to get caught the fan wire and connector in wings of the fan as it may result in damage to the inverter
- Reinstall the fan in reverse order of removal method. Before operating inverter, ensure the fan operation is normal after turning on the power supply
- Be careful about the direction of the fan

3.2 Storage and disposal

3.2.1 Storage

If you are not using the product for an extended period, store it in the following way:

- Store the product in the same environmental conditions as specified for operation
- When storing the product for a period longer than 3 months, store it between 10°C and 30°C, to prevent depletion of the electrolytic capacitor.
- Do not expose the inverter to snow, rain, fog, or dust.
- Package the inverter in a way that prevents contact with moisture. Keep the moisture level below 70% in the package by including a desiccant, such as silica gel.

3.2.2 Disposal

When disposing of the product, categorize it as general industrial waste. Recyclable materials are included in the product, so recycle them whenever possible. The packing materials and all metal parts can be recycled. Although plastic can also be recycled, it can be incinerated under controlled conditions in some regions.

Caution

If the inverter has not been operated for a long time, capacitors lose their charging characteristics and are depleted. To prevent depletion, turn on the product once a year and allow the device to operate for 30-60 min. Run the device under no-load conditions.