

Before using the product, thank you for using our Ethernet module board.

### Safety Instruction

- **To prevent injury and danger in advance for safe and correct use of the product, be sure to follow the Safety Instructions.**
- **The instructions are divided as 'WARNING' and 'CAUTION' which mean as follow.**



**WARNING**

This symbol indicates the possibility of death or serious injury.



**CAUTION**

This symbol indicates the possibility of injury or damage to property.

- **The meaning of each symbol in this manual and on your equipment is as follows**



This is the safety alert symbol.



This is the dangerous voltage alert symbol.

- **After reading the manual, keep it in the place that the user always can contact easily.**
- **Before you proceed, be sure to read and become familiar with the safety precautions at the beginning of this manual. If you have any questions, seek expert advice before you proceed. Do not proceed if you are unsure of the safety precautions or any procedure.**



**WARNING**

- **Be cautious about dealing with CMOS elements of module board.**  
It can cause malfunction by static electricity.
- **Connection changing like communication wire change must be done with power off.**  
It can cause communication faulty or malfunction.
- **Be sure to connect exactly between Inverter and module board.**  
It can cause communication faulty or malfunction.
- **Check parameter unit when setting parameter.**  
It can cause communication faulty

## Table of Contents

---

<b>Chapter 1 Introduction .....</b>	<b>1</b>
1.1 What is Ethernet?.....	1
1.2 Components .....	1
<b>Chapter 2 Ethernet Communication Module .....</b>	<b>2</b>
2.1 General Specification of Ethernet Communication Module.....	2
2.2 Layout of Ethernet Communication Module .....	2
2.3 Terminal Block Specification .....	3
2.4 Control Terminal Specification .....	4
2.5 Installation of Ethernet Communication Module.....	4
2.6 Network Cable Specification.....	6
2.7 Protocol Selection .....	7
2.8 485 Communication .....	7
<b>Chapter 3 LED Information .....</b>	<b>8</b>
3.1 Definition of the LED Signal .....	8
3.2 Ethernet Line Status LED .....	8
3.3 Modbus/TCP Status LED .....	9
3.4 Status LED of Ethernet/IP and Troubleshooting.....	10
<b>Chapter 4 Ethernet Module related Keypad Parameter .....</b>	<b>11</b>
<b>Chapter 5 General Function of Ethernet Communication .....</b>	<b>15</b>
5.1 Module Type (Module information, C 1) .....	15
5.2 Module Version (Module version information, C 2).....	15
5.3 FBus Led (Module LED information, C 5) .....	15
5.4 Ethernet Module IP, Subnet Mask, Gateway Address (C10~21).....	16
5.5 Ethernet Speed (C 4) .....	16
5.6 CIP Input Instance(C 29).....	17
5.7 CIP Output Instance (C49) .....	17
5.8 Para Status (C 31~34) .....	18
5.9 Para Control (C51~54) .....	18
5.10 Comm UpDate (C99).....	19
<b>Chapter 6 Modbus/TCP Frame.....</b>	<b>20</b>
6.1 Modbus/TCP Frame Structure.....	20
6.2 Function Code Description.....	20
6.3 Read Holding Register.....	21
6.4 Read Input Register .....	21

6.5	Write Single Register .....	22
6.6	Write Multiple Register .....	22
6.7	Except Frame .....	23
6.8	Exception Frame Structure .....	23
6.9	Exception Code Type .....	23
<b>Chapter 7</b>	<b>Ethernet/IP Frame .....</b>	<b>24</b>
7.1	Basic protocol configuration .....	24
7.2	Implicit Message .....	24
7.3	Explicit Message .....	29
7.4	Supported Object .....	29
7.5	Drive Fault Reset .....	34
7.6	AC Drive Object (Class 0x2A, Instance 1) .....	35



## Chapter 1 Introduction

### 1.1 What is Ethernet?

Ethernet communication module board connects the IG5A inverter to the Ethernet network. It supports 2 kinds of protocol, Modbus/TCP and Ethernet/IP.

Controlling and monitoring of inverter can be done by PLC sequence program or any Master Module. Since Ethernet which constitutes Internet has been used and IPv4 has been supported, wherever Internet can be done, controlling and monitoring is possible. But, Ethernet network of the factory has to be connected to Internet through gateway.

Installation time can be reduced and maintenance becomes easier just simple wiring.

### 1.2 Components

- . Ethernet Communication Module board: 1 ea
- . Ethernet Module manual: 1 ea
- . Fixed Screw (M3): 2 ea

## Chapter 2 Ethernet Communication Module

### 2.1 General Specification of Ethernet Communication Module

Transmission Speed	10Mbps, 100Mbps
Transmission Method	Baseband
Max. Extensible Distance between Nodes	100m (Node-Hub)
Max. Node Number	Hub connection
Auto-Negotiation	Supported
Max. Frame Size	1,500 bytes
Communication Zone Access Method	CSMA/CD
Frame Error Checking Method	CRC32
Recommended TCP Socket	2 Sockets

### 2.2 Layout of Ethernet Communication Module

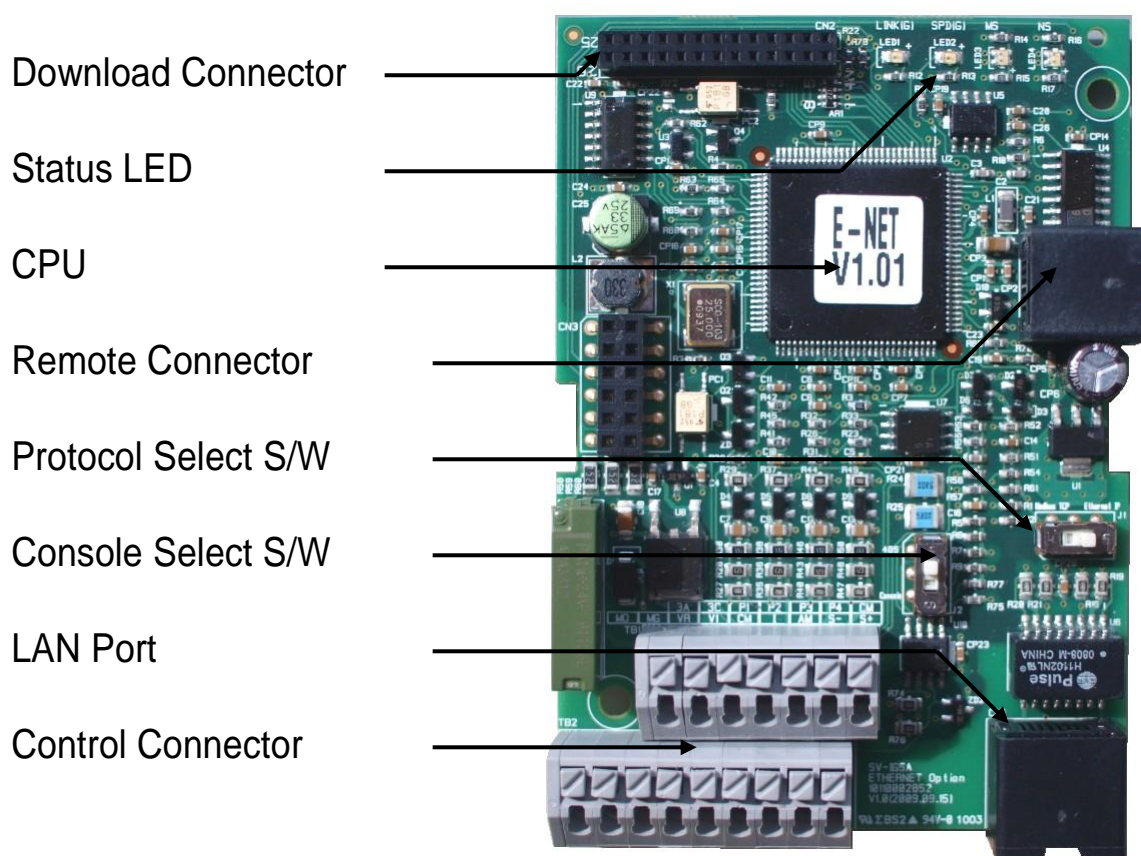

### 2.3 Terminal Block Specification

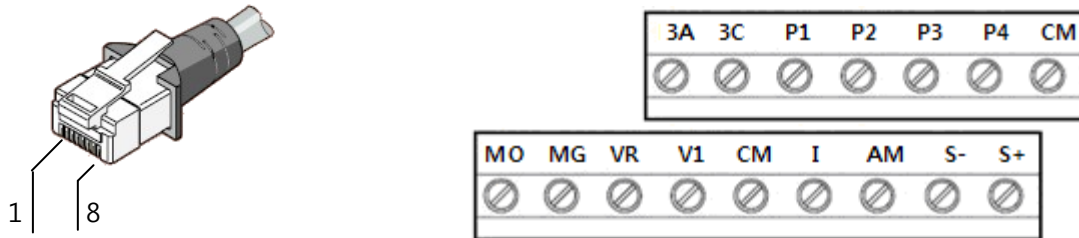

Pin No.	Signal	Description	Cable color
1	TX+	Transmitting data Plus	White / Yellow
2	TX-	Transmitting data Minus	Yellow
3	RX+	Receiving data Plus	White / Green
4	NONE	Not used	Blue
5	NONE	Not used	White / Blue
6	RX-	Receiving data Minus	Green
7	NONE	Not used	White / Brown
8	NONE	Not used	Brown

- ※ Make sure that cables connected to Pin1 and 2 are twisted together.
- ※ Make sure that cables connected to Pin3 and 6 are twisted together.

## 2.4 Control Terminal Specification

	Terminal Description	Specification
P1 ~ P4	Multi-function input terminal 1~4	-
CM	Common terminal	-
VR	Power supply for external potentiometer	Output voltage : 12V Max. output current : 100mA Potentiometer : 1~5 Kohm
V1	Input terminal for voltage operation	Max. input voltage : -10V ~ +10V input
I	Input terminal for current operation	0 ~ 20mA input internal resistor : 250 ohm
AM	Multi-function analog output terminal	Max. output voltage : 11[V] Max. output current : 10mA
MO	Multi-function terminal for open collector	Below DC 26V, 100mA
MG	Ground terminal for external power supply	-
3A	Multi-function relay output A contact	Below AC 250V, 1A
3C	Common terminal for multi-function relays	-
S+, S-	485 Communication terminal	-

## 2.5 Installation of Ethernet Communication Module

Assembly order about the dedicated iG5A inverter for communication, Ethernet communication module and keypad loader are described as below steps.

A. Prepare the dedicated iG5A inverter for communication.



- B. Take off the upper cover (②), (③) from a dedicated iG5A inverter for communication.
- C. Install Ethernet communication module (④) on the inner cover of the inverter (⑤). After installation of Ethernet communication module (④) and then install the upper cover on the inverter. Connect the communication and I/O signal cable to control the inverter. On completion of basic connection, install the upper cover (③) on the inverter.
- D. The installation is completed.
- E. Please use the portable keypad (⑥) or remote keypad for panel mounting because this communication module is non-loader type.

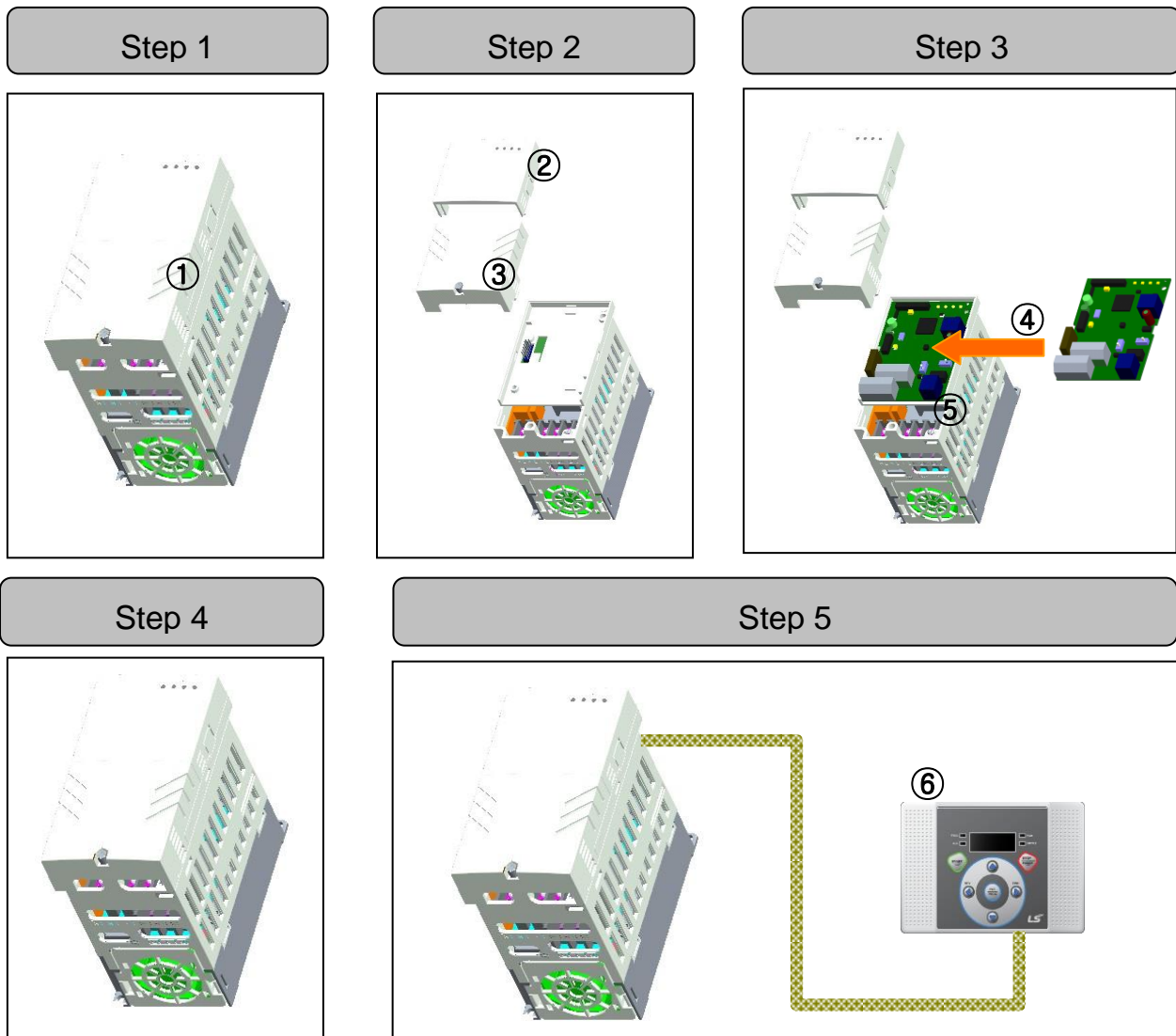

## 2.6 Network Cable Specification

Category 5 is used. Transmitting speed of category 5 is 100MHz and possible up to 100Mbps.

Classification	Detail	Used
UTP (U.UTP)	Unshielded twisted pair cable	Maximum 200MHz, Voice + Information (Data)+Low video signal
FTP (S.UTP)	Foil screened twisted pair cable	Maximum 100MHz Electromagnetic interruption (EMI) or electric stability considered, Voice+ Information (Data) + Low Video signal
STP (S.STP)	Shielded twisted pair cable	Maximum 500MHz, Voice +Information(Data)+Video signal, Replacement for 75Ω coaxial cable

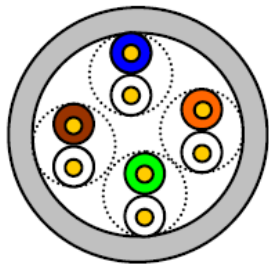

UTP

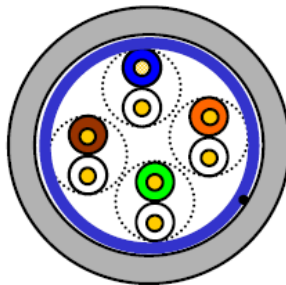

FTP

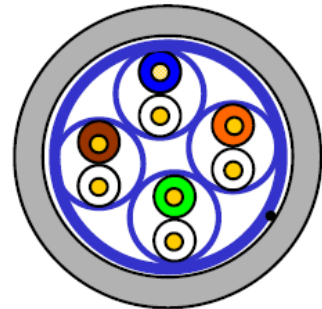

STP

## 2.7 Protocol Selection

For using the IG5A Ethernet module, you can select one of the Modbus/TCP and Ethernet/IP 2 protocol with the switch on the J1.

	Switch	Switch State	Protocol
J1		Left	Modbus/TCP
		Right	Ethernet/IP
J2		Up	RS-485 Enable
		Down	RS-485 Disable

When the Module is in operation, changing the switch position does not change the protocol.

The protocol is selected and set up according to the switch position at the power-on or initialization of the module with the C99 parameter set to 1.

## 2.8 485 Communication

Connect the RS-485 communication cable to S+ and S- terminals on control terminal block.

[Related Parameter]

drv	[Drive mode]	: 4 (Field Bus)
Freq.	[Frequency setting method]	: 9 (Field Bus)
I 60	[Inverter number]	: 1~250
I 61	[Baudrate]	: 3 (9,600 bps, Factory default)
I 59	[Communication protocol select]	: 0 (Modbus RTU)

- To use RS-485 communication through module, Set Drive mode and Frequency setting method to Field Bus in advance.
- Only Modbus RTU protocol is supported.
- RS-485 communication can be used when J2 switch must be placed on up state (485).

## Chapter 3 LED Information

### 3.1 Definition of the LED Signal

IG5A Ethernet Communication Module, 4 LEDs which indicate the Modbus/TCP state to the user are installed. In IG5A Ethernet Communication Module, LEDs are displayed as below

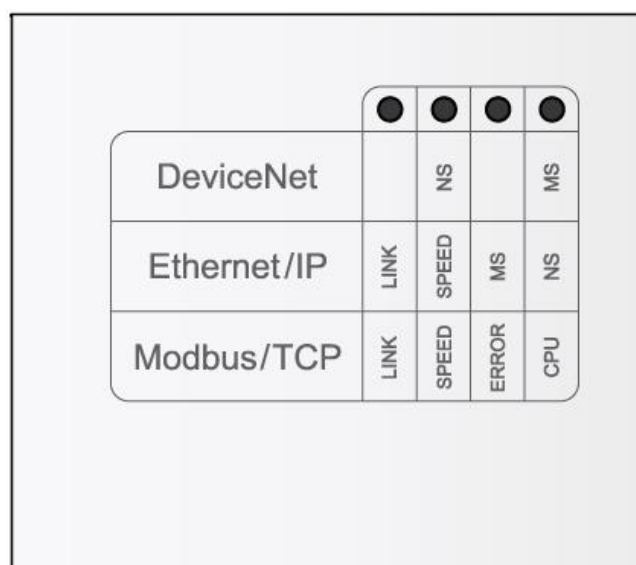

### 3.2 Ethernet Line Status LED

LED	Color	Function
Speed	Green	ON – It indicates the communication speed is 100Mbps. OFF – It indicates the communication speed is 10Mbps.
Link	Green	ON – It indicates the communication module is ready to communicate. OFF – In case wiring of communication cable has a fault, Link LED is turned Off. Check if wiring is correct.

### 3.3 Modbus/TCP Status LED

LED	Color	Function and Troubleshooting
CPU	Green	<ul style="list-style-type: none"> <li>● Blinking – It means IG5A Ethernet Communication Module CPU is operating normally when the power is well supplied to IG5A Ethernet module.</li> <li>● Off – Failure in power supply to the Ethernet communication module. Re-install the module.</li> </ul>
ERROR	Red	<ul style="list-style-type: none"> <li>● Off – It means IG5A Ethernet Communication Module module is normal without Error.</li> <li>● On – It means IP address sets to 0.0.0.0 or 255.255.255.255. The IP address of 0.0.0.0 and 255.255.255.255 are reserved. Do not use the address.</li> <li>● CPU and ERROR LEDs are blinking as same cycle –               <ol style="list-style-type: none"> <li>1. It means inverter communication is interrupted. Turn off the inverter power and then reinstall the module.</li> <li>2. Data from inverter can not be updated to Ethernet Module. Do Comm. Update or re-generated the power again.</li> </ol> </li> <li>● CPU LED is blinking faster than ERROR LED blinking cycle - IP address is conflicted in a network. Check if IP address is appropriate.</li> </ul>

### 3.4 Status LED of Ethernet/IP and Troubleshooting

LED	Color	Function and Troubleshooting
NS	Green	<ul style="list-style-type: none"> <li>● Off –It means Client and TCP are not connected.</li> <li>● Blinking – It means UCMM communication is available by registering Register after Client and TCP are connected.</li> <li>● On –It means the status is I/O communicating because Class 1 connection has completed.</li> </ul>
	Red	<ul style="list-style-type: none"> <li>● Off – Normal network</li> <li>● Blinking – It means Class 1 connection is interrupted abnormally. Check if the Network cable and connection state is correct.</li> <li>● On – Displayed if there is an IP address that was just configured is already in use on the network.</li> </ul>
MS	Green	<ul style="list-style-type: none"> <li>● On – It means communication module board is normal.</li> <li>● Off – It means communication module board has a problem.</li> </ul>
	Red	<ul style="list-style-type: none"> <li>● On – Displayed if IP address is set as 0.0.0.0 or 255.255.255.255. The IP address of 0.0.0.0 and 255.255.255.255 are reserved. Do not use the address.</li> <li>● Blinking – <ol style="list-style-type: none"> <li>1. It means inverter communication is interrupted. Turn off the inverter power and then reinstall the module.</li> <li>2. Data from inverter can not be updated to Ethernet Module. Do Comm. Update or re-generated the power again.</li> </ol> </li> <li>● OFF – It means Communication module board is normal.</li> </ul>

LED is turned On in order when module is initialized with Ethernet/IP selected and On/Off in order of MS Green → MS Red → NS Green → NS Red. It will recognize normally after the initial communication time (about 30 seconds) of server (inverter) when Ethernet is connected. Do not use Comm Update (C99 → 1) when inverter is in operating or cyclic communication.

## Chapter 4 Ethernet Module related Keypad Parameter

The related inverter parameters of Modbus/TCP and Ethernet/IP are listed as shown below.

note) Protocol abbreviation: Ethernet/IP to E, Modbus/TCP to T  
The parameter is different from protocol.

Code	Name of Parameter	Initial value	Range	Definition	Protocol note)	
					E	T
DRV (A103)	Drive mode	0	0 : Keypad 1 : Fx/Rx-1 2 : Fx/Rx-2 3 : Int. 485 4 : FieldBus	To command Inverter through Ethernet, it requires the setting as "4 (FieldBus)"	0	0
Frq (A104)	Frequency setting method	1	1 : Keypad 2 : -10 ~ 10V 3 : 0 ~ 10V 4 : 0 ~ 20mA 5 : "2" + "4" 6 : "3" + "4" 7 : Int. 485 8 : Digital Volume 9 : FieldBus	To command Inverter frequency through Ethernet, it requires setting as "9 (FieldBus)".	0	0
C 1 (A501)	FieldBus Module Name	-	-	When IG5A Ethernet communication module is installed, it indicates EnEt.	0	0
C 2 (A502)	S/W Version	-	-	It indicates the version of Ethernet communication module.	0	0
C 4 (A504)	FieldBus Baudrate	Auto	Auto 10M 100M	It requires the setting of Baudrate used in the network which inverter is connected.	0	0
C 5	FieldBus	-	-	-	0	0

Code	Name of Parameter	Initial value	Range	Definition	Protocol note)	
					E	T
(A505)	LED Status					
C10 (A60A)	IP Address 1	0	0 ~ 255	First byte of IP address	0	0
C11 (A60B)	IP Address 2	0	0 ~ 255	Second byte of IP address	0	0
C12 (A60C)	IP Address 3	0	0 ~ 255	Third byte of IP address	0	0
C13 (A60D)	IP Address 4	0	0 ~ 255	Fourth byte of IP address	0	0
C14 (A60E)	Subnet Mask 1	0	0 ~ 255	First byte of Subnet Mask	0	0
C15 (A60F)	Subnet Mask 2	0	0 ~ 255	Second byte of Subnet Mask	0	0
C16 (A610)	Subnet Mask 3	0	0 ~ 255	Third byte of Subnet Mask	0	0
C17 (A611)	Subnet Mask 4	0	0 ~ 255	Fourth byte of Subnet Mask	0	0
C18 (A612)	Gateway 1	0	0 ~ 255	First byte of Gateway	0	0
C19 (A613)	Gateway 2	0	0 ~ 255	Second byte of Gateway	0	0
C20 (A614)	Gateway 3	0	0 ~ 255	Third byte of Gateway	0	0
C21 (A615)	Gateway 4	0	0 ~ 255	Fourth byte of Gateway	0	0
C 29 (A51D)	In Instance	70	70 71 110 111 141 142 143	Set the value of input instance to be used in Class 0x04 (Assembly Object). As this parameter value is set, the data type to be received (Master-based) at Poll I/O communication	0	X



## Chapter 4 Ethernet Module related Keypad Parameter

Code	Name of Parameter	Initial value	Range	Definition	Protocol note)	
					E	T
			144	is decided.		
C 30 (A61E)	Parameter Status Number	-	-	Set value of parameter varies depending on the set value of C29.	O	X
C 31 (A61F)	Parameter Status 1	0	0 ~ 0xFFFF	Enter the address of the inverter data to send to the Client (Originator).	O	X
C 32 (A620)	Parameter Status 2	0	0 ~ 0xFFFF		O	X
C33 (A621)	Parameter Status 3	0	0 ~ 0xFFFF		O	X
C34 (A622)	Parameter Status 4	0	0 ~ 0xFFFF		O	X
C49 (A631)	Out Instance	20	20 21 100 101 121 122 123 124	Set the value of output instance to be used in the Class 0x04 (Assembly Object). As this Parameter value is set, the data type to be sent (Master-based) at the time of Poll I/O communication is decided.	O	X
C50 (A632)	Parameter Control Number	-	-	Set value of this Parameter varies depending on the set value of C49.	O	X
C51	Parameter	0	0 ~ 0xFFFF	Enter the address of the	O	X

Code	Name of Parameter	Initial value	Range	Definition	Protocol note)	
					E	T
(A633)	Control 1			inverter data which will make use of the command data of the Client (Originator).		
C52 (A634)	Parameter Control 2	0	0 ~ 0xFFFF		O	X
C53 (A635)	Parameter Control 3	0	0 ~ 0xFFFF		O	X
C54 (A636)	Parameter Control 4	0	0 ~ 0xFFFF		O	X
C99 (A663)	Communication Update	0	0 : No 1 : Yes	It is used when Comm Update is executed to Ethernet communication module. In the event of setting C99 at "1 (Yes)", it carries out initialization and then automatically displays "0 (No)".	O	O

## Chapter 5 General Function of Ethernet Communication

### 5.1 Module Type (Module information, C 1)

The type of communication module installed in inverter is displayed automatically.

If Ethernet communication module is installed, “EnEt” message will be displayed.

### 5.2 Module Version (Module version information, C 2)

Version of communication module installed in inverter is displayed automatically.

### 5.3 FBus Led (Module LED information, C 5)

#### ① In case of Modbus/TCP

The state of LINK, SPD, ERR, CPU LED in iG5A Ethernet communication module is displayed at keypad parameter C 5.

If you check C 9 FBus LED with Keypad, 4 LEDs can be seen according to the order of LED of C 5 (Left → Right) LINK, SPD, ERR, CPU LED.

When LED is ON, the relevant bit becomes 1 and when OFF, it becomes 0.

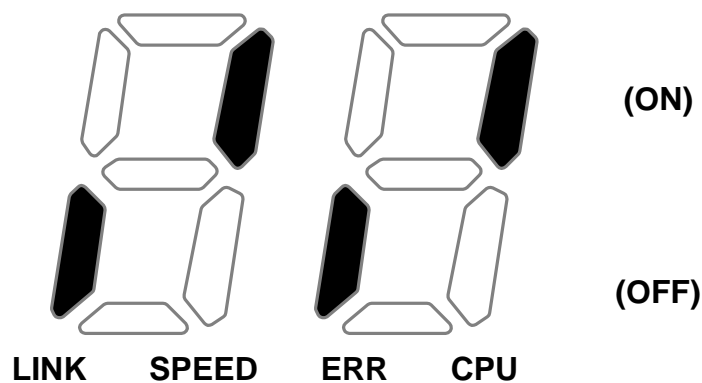

LINK LED	SPEED LED	ERR LED	CPU LED
OFF	ON	OFF	ON

#### ② In case of Ethernet/IP

Ethernet communication module has MS LED and NS LED only, but four (4) LEDs are shown from C5 (FieldBus LED Status) using Keypad. It displays the information of NS LED Red, NS LED Green, MS LED Red and MS LED Green in the order of C5 LEDs (Left → Right).  
 If C5 is displayed as below, it indicates that current NS LED is Green and MS LED is Green.

**(Example of C5 LED status)**

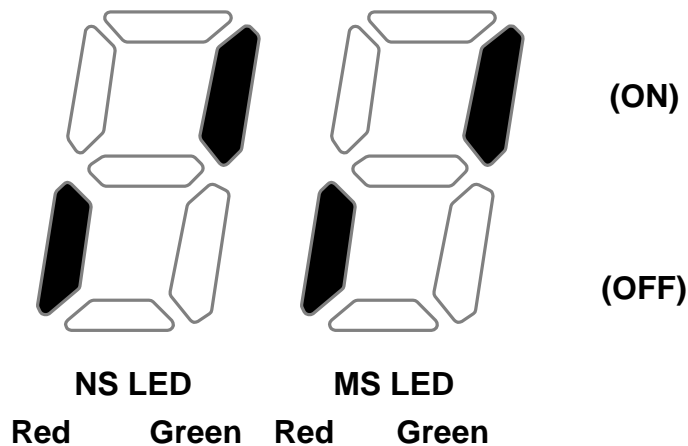

NS LED Red	NS LED Green	MS LED Red	MS LED Green
OFF	ON	OFF	ON

**5.4 Ethernet Module IP, Subnet Mask, Gateway Address (C10~21)**

IP version that Ethernet module supports is v4. All the addresses and masks are expressed as Decimal number. Decimal number. Decimal number. Decimal number and a number between 0 and 255 is input for each decimal number.

Ex) To set IP address of 196.168.10.131, follow the below settings.

- Input 196 for C10
- Input 168 for C11
- Input 10 for C12
- Input 131 for C13

**5.5 Ethernet Speed (C 4)**

Ethernet speed can be set within the range of 0~2.

Setting value	Baud Rate
Auto	Auto Negotiation
100M	100Mbps
10M	10Mbps

Automatic Speed Setting function set the maximum baudrate automatically in a network. If LINK LED not recognizes the baudrate when it is connected to a hub, change the speed and then connect to the hub.

### 5.6 CIP Input Instance(C 29)

This parameter is displayed when the protocol setting is the Ethernet/IP. It sets up the data format of the inverter status sent from the inverter to the Client (Originator) during the I/O communication module of the CIP (Common Industrial Protocol). Refer to the Assembly Object of the Ethernet/IP.

Input Instance Value	Data Size	Number of Parameter
70	4	X
71	4	X
110	4	X
111	4	X
141	2	1
142	4	2
143	6	3
144	8	4

### 5.7 CIP Output Instance (C49)

This parameter is displayed only when protocol sets to Ethernet/IP. It sets up the data format of the inverter command sent from the Client (Originator) to control the inverter during the I/O communication module of the CIP

(Common Industrial Protocol). Refer to the Assembly Object of the Ethernet/IP.

<b>Output Instance Value</b>	<b>Data Size</b>	<b>Number of Parameter</b>
20	4	X
21	4	X
100	4	X
101	4	X
121	2	1
122	4	2
123	6	3
124	8	4

### **5.8 Para Status (C 31~34)**

This parameter is displayed only when protocol sets to Ethernet/IP. It will be displayed when Input Instance (C29) value is above 141 at Ethernet/IP. The C30 (Para Status Num) setting is not available. The number of the parameters of the set-up instance is indicated. Enter the address of the inverter data to send to the Client (Originator) in C31 ~ C34, by the number of the parameters shown. This parameter will be shown when Comm Update (C 99) sets to 1 (Yes).

### **5.9 Para Control (C51~54)**

This parameter is displayed only when protocol sets to Ethernet/IP. It will be displayed when Output Instance (C49) value is above 121 at Ethernet/IP. The C50 (Para Ctrl Num) setting is not available. The number of the parameters of the set-up instance is indicated. Enter the address of the inverter data which will make use of the command data of the Client (Originator) in C51 ~ C54, by the number of the parameters shown. This parameter will be shown when Comm Update (C 99) sets to 1 (Yes).

### 5.10 Comm UpDate (C99)

Parameters will be displayed the previous value when power is energized. If the parameter is changed, the value is not applied immediately. If Comm Update is set to 1(Yes), the value is applied to Ethernet Communication module immediately and then only Ethernet communication module re-starts.

## Chapter 6 Modbus/TCP Frame

### 6.1 Modbus/TCP Frame Structure



Generally, Ethernet uses Ethernet II Frame

#### MODBUS Application Protocol Header (MBAP Header)

Header	Length	Description
Transaction Identifier	2 Bytes	As an unique transmitting number, It is increased by 1 each time when Data frame is send to server from client
Protocol Identifier	2 Bytes	Fixed as 0.
Length	2 Bytes	Modbus Data Frame length. It means the byte length from MBAP Header to Unit Identifier.
Unit Identifier	1 Byte	When Modbus/TCP and Modbus RTU are connected with Gate, Slave number is written. When Modbus/ TCP is only used, it is fixed as 0xFF.

#### Protocol Data Unit (PDU)

AS an actual Data of Modbus/TCP, It is consists of Function Code and Data.

### 6.2 Function Code Description

Modbus/TCP can be divided into Client and Server. Client gives the command and Server responds to the command. Generally, as Client, there are PLC, HMI and PC so on, and Server means inverter.



### 6.3 Read Holding Register

It is a function for reading data from inverter (Server).

#### Frame configuration that client requires to server

Required Frame	Length	Value
Function Code	1 Byte	0x03
Comm. Address	2 Bytes	0x0000 ~ 0xFFFF
Required Data Number	2 Bytes	1~16

#### Frame configuration that server responds to master

Responded Frame	Length	Value
Function Code	1 Byte	0x03
Comm. Address	1 Byte	2 x Required data number
Required Data Number	Required data number x 2 Bytes	The required data number according to the number of communication address

### 6.4 Read Input Register

It is a function for reading data from Inverter (Server).

#### Frame configuration that client requires to server

Required Frame	Length	Value
Function Code	1 Byte	0x04
Comm. Address	2 Bytes	0x0000 ~ 0xFFFF
Required Data Number	2 Bytes	1~16

#### Frame configuration that server responds to master

Responded Frame	Length	Value
Function Code	1 Byte	0x04
Comm. Address	1 Byte	2 x Required data number
Required Data Number	Data required number x 2 Bytes	The required data number from communication address

## 6.5 Write Single Register

It is a function for modifying a data of Inverter (Server).

### Frame configuration that client requires to server

Required Frame	Length	Value
Function Code	1 Byte	0x06
Comm. Address	2 Bytes	0x0000 ~ 0xFFFF
Required Data Number	2 Bytes	0x0000 ~ 0xFFFF

### Frame configuration that server responds to master

Responded Frame	Length	Value
Function Code	1 Byte	0x06
Comm. Address	2 Bytes	0x0000 ~ 0xFFFF
Required Data Number	2 Bytes	0x0000 ~ 0xFFFF

## 6.6 Write Multiple Register

It is a function for modifying the consecutive data from 1 up to 16 of inverter (Server).

### Frame configuration that client requires to server.

Required Frame	Length	Value
Function Code	1 Byte	0x10
Comm. Address	2 bytes	0x0000 ~ 0xFFFF
Modifying data number	2 bytes	1~16
Byte Count	1 Byte	2 X Number of data
Data value to be modified	Number of data x 2 bytes	Data for modifying

### Frame configuration that server responds to master

Responded Frame	Length	Value
Function Code	1 Byte	0x10
Comm. Address	2 Bytes	0x0000 ~ 0xFFFF
Modifying Data number	2 Bytes	1~16

## 6.7 Except Frame

Except frame is a responding frame from server in case an error happens at sending the required frame from client.

## 6.8 Exception Frame Structure

Error Frame	Length	Value
Error Code	1 Byte	0x80 + Function Code that client requires
Exception Code	1 Byte	0x0000 ~ 0xFFFF

## 6.9 Exception Code Type

Type	Code	Description
ILLEGAL FUNCTION	0x01	In case non-supported Function is required.
ILLEGAL DATA ADDRESS	0x02	Unused address is required or to be modified.
ILLEGAL DATA VALUE	0x03	The modified data exceeds the permitted range when you try to modify the data.
SLAVE DEVICE FAILURE	0x04	In case there is error in server (Communication failure with inverter, Initialization failure)
SLAVE DEVICE BUSY	0x06	In case the server can't respond due to other process (such as Inverter parameter initialization or module initialization setting)
WRITE PERMISSION ERROR	0x20	In case the value can not be modified because the value is prohibited to modify.

## Chapter 7 Ethernet/IP Frame

### 7.1 Basic protocol configuration

The Ethernet/IP is a protocol implemented with the CIP (Common Industrial Protocol) defined by the ODVA using TCP and UDP.

Originator: the device requesting connection. Also, it is called a Client. The equivalent device is a PLC or a scanner.

Target: the device which responds to the connection request. Also, it is called a Server. The equivalent device is an Inverter.

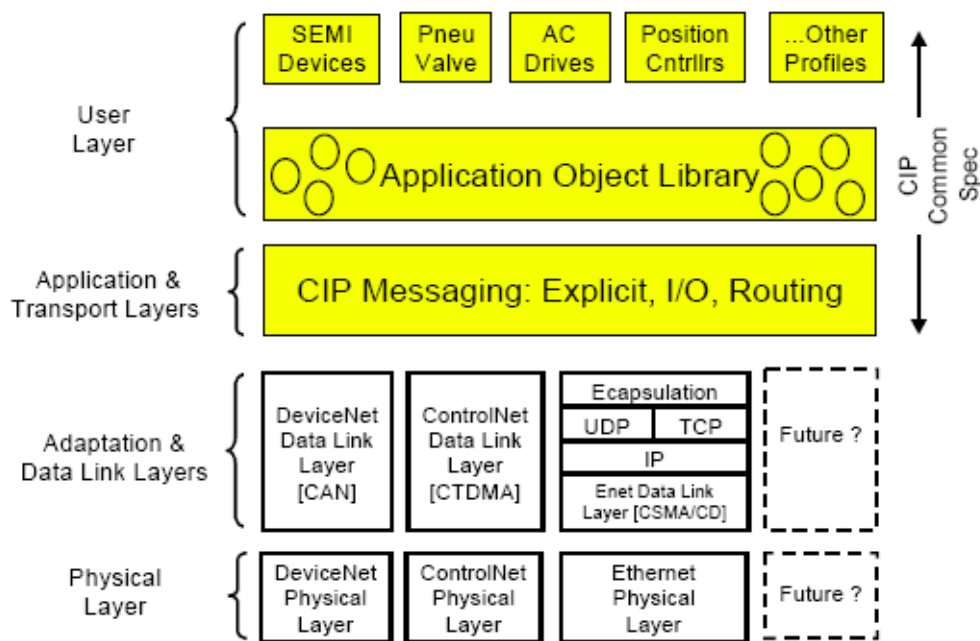

### 7.2 Implicit Message

The Implicit Message is also called I/O Message, which is the data communicated between the Client (Originator) and Server (Target) at preset period by the Input Instance and Output Instance.

The connection is in Class 1 Connection

① **Supported range**

- Transport Type  
Originator->Target: Point to Point  
Target->Originator: Multicast
- Transport Trigger: Cyclic
- Configuration Connection: 1
- Connection Tag: Not supported
- Priority  
Originator->Target: Scheduled  
Target->Originator: Scheduled  
Configuration Data: Not supported

② **Input Instance**

These are the data of the Inverter status periodically sent from the Inverter to PLC or a Client device.

Instance	Byte	Bit 7	Bit 6	Bit 5	Bit 4	Bit 3	Bit 2	Bit 1	Bit 0
70	0	-	-	-	-	-	Runn- ing 1 (Fwd)	-	Fault- ed
	1	-							
	2	Speed Actual (Low Byte) – RPM unit							
	3	Speed Actual (High Byte) – RPM unit							
71	0	At Refe- rence	Ref From Net	Ctrl From Net	Ready	Runn- ing 2 (Rev)	Runn- ing 1 (Fwd)	Warn- ing	Fault- ed
	1	-							
	2	Speed Actual (Low Byte) – RPM unit							
	3	Speed Actual (High Byte) – RPM unit							
110	0	-	-	-	-	-	Runn- ing 1 (Fwd)	-	Fault- ed
	1	-							
	2	Speed Actual (Low Byte) – Hz unit							
	3	Speed Actual (High Byte) – Hz unit							

Instance	Byte	Bit 7	Bit 6	Bit 5	Bit 4	Bit 3	Bit 2	Bit 1	Bit 0
111	0	At Reference	Ref From Net	Ctrl From Net	Ready	Running 2 (Rev)	Running 1 (Fwd)	Warning	Faulted
	1	-							
	2	Speed Actual (Low Byte) – Hz unit							
	3	Speed Actual (High Byte) – Hz unit							
141	1	Status Parameter - 1 data (Low Byte)							
	2	Status Parameter - 1 data (High Byte)							
142	1	Status Parameter - 1 data (Low Byte)							
	2	Status Parameter - 1 data (High Byte)							
	3	Status Parameter - 2 data (Low Byte)							
	4	Status Parameter - 2 data (High Byte)							
143	1	Status Parameter - 1 data (Low Byte)							
	2	Status Parameter - 1 data (High Byte)							
	3	Status Parameter - 2 data (Low Byte)							
	4	Status Parameter - 2 data (High Byte)							
	5	Status Parameter - 3 data (Low Byte)							
	6	Status Parameter - 3 data (High Byte)							
144	1	Status Parameter - 1 data (Low Byte)							
	2	Status Parameter - 1 data (High Byte)							
	3	Status Parameter - 2 data (Low Byte)							
	4	Status Parameter - 2 data (High Byte)							
	5	Status Parameter - 3 data (Low Byte)							
	6	Status Parameter - 3 data (High Byte)							
	7	Status Parameter - 4 data (Low Byte)							
	8	Status Parameter - 4 data (High Byte)							

The table below presents the description of the bit data for the 0, 1 byte of 70, 71, 110, and 111.

Name	Description	Related Attribute	
		Class	Attr. ID
Faulted	Inverter Error	0x29	10
Warning	Not Supported	0x29	11
Running 1	Motor is forward running.	0x29	7
Running 2	Motor is reverse running.	0x29	8
Ready	Motor is ready to running.	0x29	9
Ctrl From Net	Run/Stop control	0x29	15
Ref From Net	Speed control	0x2A	29
At Reference	Reach at reference speed	0x2A	3
Drive State	Current Motor State	0x29	6
Speed Actual	Speed Command	0x2A	7

### ③ Output Instance

These are the command data sent from PLC or a Client device to the Inverter, on periodical frequency.

Instance	Byte	Bit 7	Bit 6	Bit 5	Bit 4	Bit 3	Bit 2	Bit 1	Bit 0
20	0	-	-	-	-	-	Fault Reset	-	Run Fwd
	1	-							
	2	Speed Reference (Low Byte) – RPM unit (not supported)							
	3	Speed Reference (High Byte) – RPM unit (not supported)							
21	0	-	Net Ref <small>note2)</small>	Net Ctrl <small>note2)</small>	-	-	Fault Reset	Run Rev	Run Fwd
	1	-							
	2	Speed Reference (Low Byte) – RPM unit (not supported)							
	3	Speed Reference (High Byte) – RPM unit (not supported)							
100	0	-	-	-	-	-	Fault Reset	-	Run Fwd

Instance	Byte	Bit 7	Bit 6	Bit 5	Bit 4	Bit 3	Bit 2	Bit 1	Bit 0
	1	-							
	2	Speed Reference (Low Byte) – Hz unit							
	3	Speed Reference (High Byte) – Hz unit							
101	0	-	Net Ref <small>note2)</small>	Net Ctrl <small>note2)</small>	-	-	Fault Reset	Run Rev	Run Fwd
	1	-							
	2	Speed Reference (Low Byte) – Hz unit							
	3	Speed Reference (High Byte) – Hz unit							
121	1	Control Parameter - 1 data (Low Byte)							
	2	Control Parameter - 1 data (High Byte)							
122	1	Control Parameter - 1 data (Low Byte)							
	2	Control Parameter - 1 data (High Byte)							
	3	Control Parameter - 2 data (Low Byte)							
	4	Control Parameter - 2 data (High Byte)							
123	1	Control Parameter - 1 data (Low Byte)							
	2	Control Parameter - 1 data (High Byte)							
	3	Control Parameter - 2 data (Low Byte)							
	4	Control Parameter - 2 data (High Byte)							
	5	Control Parameter - 3 data (Low Byte)							
	6	Control Parameter - 3 data (High Byte)							
124	1	Control Parameter - 1 data (Low Byte)							
	2	Control Parameter - 1 data (High Byte)							
	3	Control Parameter - 2 data (Low Byte)							
	4	Control Parameter - 2 data (High Byte)							
	5	Control Parameter - 3 data (Low Byte)							
	6	Control Parameter - 3 data (High Byte)							
	7	Control Parameter - 4 data (Low Byte)							
	8	Control Parameter - 4 data (High Byte)							



The table below presents the data description of the 0Byte of 20, 21, 100, and 101.

Name	Description	Related Attribute	
		Class	Attr. ID
Run Fwd <sup>note1)</sup>	Forward Run Command	0x29	3
Run Rev <sup>note1)</sup>	Reverse Run Command	0x29	4
Fault reset <sup>note1)</sup>	Fault Reset Command	0x29	12
NetRef <sup>note2)</sup>	Not used	0x2A	4
NetCtrl <sup>note2)</sup>	Not used	0x29	5
Speed Reference	Speed Command	0x2A	8

note 1) Refer to the Drive Run and Fault in the Control Supervisor Object (Class 0x29).

note2) The settings of the Reference Control and Run/Stop Control can be made only on the LCD Control Panel. Therefore, NetRef and NetCtrl are not used at the Instances 21 and 101.

### 7.3 Explicit Message

A non-periodic communication method used to read or write the attribute value of the Inverter or Ethernet/IP.

The UCMM method which can communicate data between Originator and Target without connection, and a periodic data communication method using Class 3 Connection are available.

### 7.4 Supported Object

#### ① Identity Object (Class 0x01, Instance 1)

##### [ Attribute ]

Attribute ID	Access	Attribute Name	Data Length	Attribute Value
1	Get	Vendor ID (LS Industrial systems)	Word	259
2	Get	Device Type (AC Drive)	Word	2
3	Get	Product Code	Word	10 <sup>note1)</sup>
4	Get	Low Byte - Major revision High Byte - Minor revision	Word	<sup>note2)</sup>
5	Get	Status	Word	<sup>note4)</sup>

Attribute ID	Access	Attribute Name	Data Length	Attribute Value
6	Get	Serial Number	Double Word	note3)
7	Get	Product Name	12 Byte	IG5A Ethernet

note 1) Product code '10' means iG5A AC drive.

note 2) The Upper and Lower byte represent the Major Revision and Minor Revision, respectively. For example, 0x0102 means 2.01. The version of the Ethernet communication is indicated in the Keypad C 6 FieldBus S/W Ver.

note 3) Serial number is made by last four numbers of MAC ID. For example, if MAC ID is 00:0B:29:00:00:22, Serial number is 0x29000022.

note 4) Definition of the bit of status

Bit	Definition
0	0: Device is not connected to Master. , 1: Device is connected to Master.
1	Reserved
2	Configured (always '0' since the IG5A Ethernet/IP is not supported.)
3	Reserved
4	0: Unknown ,
5	2: in case of incorrect I/O connection.
6	3: in case of no previous I/O connection at all.
7	5: Major Fault 6: I/O in connection.
8	Minor Recoverable Fault (In case of Warning state of inverter)
10	Major Recoverable Fault (In case of H/W trip state of inverter)
11	Major Unrecoverable Fault (In case of trip state except for H/W trip of inverter)

**[ Service ]**

Service Code	Definition	Support for Class	Support for Instance
0x0E	Get Attribute Single	Yes	Yes
0x05	Reset	No	Yes
0x10	Set Attribute Single	No	Yes

**② Motor Data Object (Class 0x28, Instance 1)**

**[ Attribute ]**

Attribute ID	Access	Attribute Name	Range	Definition
3	Get	Motor Type	7	Squirrel-cage induction motor (Fixed value)
6	Get/Set	Motor Rated Current	0 ~ 0xFFFF	[Get] Reads P32 of the motor rated current. [Set] The setting value is reflected on P32 of the motor rated current. Scale: 0.1
7	Get/Set	Motor Rated Voltage	0 ~ 0xFFFF	Not supported

**[ Service ]**

Service Code	Definition	Support for Class	Support for Instance
0x0E	Get Attribute Single	Yes	Yes
0x10	Set Attribute Single	No	Yes

**③ Control Supervisor Object (Class 0x29, Instance 1)****[ Attribute ]**

Attribute ID	Access	Attribute Name	Range	Definition
3	Get / Set	Forward Run Cmd.	0	Stop
			1	Forward operation <sup>note 1)</sup>
4	Get / Set	Reverse Run Cmd.	0	Stop
			1	Reverse operation <sup>note 1)</sup>
5	Not supported	NetCtrl	-	Only settable as an Inverter parameter
6	Get	Drive State	0	Vendor Specific
			1	Startup
			2	Not Ready (during reset)

Attribute ID	Access	Attribute Name	Range	Definition
			3	Ready (during stopping)
			4	Enabled (during running, excluding deceleration during a run-to-stop)
			5	Stopping (deceleration during run-to-stop)
			6	Fault Stop
			7	Faulted (trip occurred)
7	Get	Running Forward	0	During stopping
			1	In operation in forward
8	Get	Running Reverse	0	During stopping
			1	In operation in reverse
9	Get	Drive Ready	0	When during reset or trip occurred
			1	Normal Inverter status
10	Get	Drive Fault	0	No current trip
			1	Under tripped status
12	Get / Set	Drive Fault Reset	0	Trip reset after a trip.
			1	
13	Get	Drive Fault Code	-	See the Drive Fault Code table below. <small>Note 2)</small>
14	Not supported	Control From Net.	0	Operation command is sent by other sources except for communication.
			1	Operation command is sent by communication source.

**[ Service ]**

Service Code	Definition	Support for Class	Support for Instance
0x0E	Get Attribute Single	Yes	Yes
0x10	Set Attribute Single	No	Yes

note 1) Drive Run Command : Inverter operation using the Forward Run Command and Reverse Run Command

Run1	Run2	Trigger Event	Run Type
0	0	Stop	NA
0->1	0	Run	Run1
0	0->1	Run	Run2
0->1	0->1	No Action	NA
1	1	No Action	NA
1->0	1	Run	Run2
1	1->0	Run	Run1

In the Table above, the Run 1 is the Forward Run Command and Run 2 is the Reverse Run Command. That is, at the moment of change; 0(FALSE) → 1(TRUE), the module gives the operation command to inverter. The value of Forward Run Command means that the indication is not the present state of the Inverter operation but that is the operation command value of the module.

note 2) Drive Fault : In case inverter has a fault, Drive Fault becomes TRUE. Drive Fault Code table below.

**Drive Fault Code**

Fault Code Number	Description		
0x0000	None		
0x1000	Electronic thermal	Output phase loss	Inverter overload
	Input phase loss	Self-diagnostic malfunction	Remote keypad communication error
	Parameter save error	Communication error	Keypad error
	Lost command	Brake control error	-
0x2200	Overload		
0x2310	Overcurrent		
0x2330	Ground fault		
0x2340	Overcurrent2		
0x3210	Over voltage		
0x3220	Low voltage		
0x4000	NTC Open		
0x4200	Inverter overheat		
0x5000	Inverter hardware fault		
0x7000	Cooling fan fault		

Fault Code Number	Description
0x9000	External fault A,B contact input    Instant cut off(Emergency Stop)

### 7.5 Drive Fault Reset

When the Drive Fault Reset is changed; 0 →1 (FALSE to TRUE), the TRIP RESET command is given to the Inverter. One additional 1 (TRUE) in 1 (TRUE) state does not provide TRIP RESET command to the Inverter. To provide this command to the Inverter in 1 (TRUE) state, write 0 (FAULT) in 1 (TRUE) state and then write 1 (TRUE). After that, RESET command will be applied.

## 7.6 AC Drive Object (Class 0x2A, Instance 1)

## [ Attribute ]

Attribute ID	Access	Attribute Name	Range	Definition
3	Get	At Reference	0	The output frequency has not reached the set-up frequency.
			1	The output frequency has reached the set-up frequency.
4	Not supported	Net Reference	-	-
6	Get	Drive Mode	0	Vendor Specific Mode
			1	Open Loop Speed (Frequency) -. Voltage/frequency Control -. Slip compensation control -. Sensorless vector control
			2	Closed Loop Speed Control
			3	Torque Control
			4	Process Control (e.g.PI)
7	Get	Speed Actual	0~12,000 (rpm)	Indicates the current output frequency in [rpm] unit.
8	Not supported	Speed Ref	-	-
9	Get	Actual Current	-	Monitors the current in 0.1 A unit
29	Not supported	RefFromNet	0	The frequency command source is not the Fieldbus communication.
			1	The frequency command source is the Fieldbus communication
100	Get	Actual Hz	0~400.00 (Hz)	Monitors the current operating frequency in Hz unit.
101	Get/Set	Reference Hz	0~400.00 (Hz)	Frequency setting method has to be set to FieldBus to apply this.
102	Get/Set	Acceleration Time <sup>note1)</sup>	0~6,000.0 (sec)	Set-up and monitor the Inverter accelerating time.
103	Get/Set	Deceleration Time <sup>note2)</sup>	0~6,000.0 (sec)	Set-up and monitor the Inverter decelerating time

note 1) It is related with the Acc Time.

note 2) It is related with the Dec Time.

**[ Service ]**

Service Code	Definition	Support for Class	Support for Instance
0x0E	Get Attribute Single	Yes	Yes
0x10	Set Attribute Single	No	Yes

**Class 0x64 (Inverter Object) – Manufacture Profile**

This is the object to access the keypad parameter of the Inverter.

**[ Attribute ]**

Instance	Access	Attribute Number	Attribute Name	Attribute Value
1 (D Group)	Get/Set	Same as IG5A Parameter No.	IG5A Keypad Title (See IG5A Manual)	Setting range of IG5A Parameter (See IG5A Manual )
2 (F Group)				
3 (H Group)				
4 (I Group)				
5 (C Group)				

**[ Service ]**

Service Code	Definition	Support for Class	Support for Instance
0x0E	Get Attribute Single	Yes	Yes
0x10	Set Attribute Single	No	Yes

The Read Only which is an attribute of the Inverter parameter does not support Set Service.



# Warranty

Maker	LS Industrial Systems Co., Ltd.	Installation (Start-up) Date	
Model No.	iG5A Ethernet Module	Warranty Period	
Customer Information	Name		
	Address		
	Tel.		
Sales Office (Distributor)	Name		
	Address		
	Tel.		

Warranty period is 12 months after installation or 18 months after manufactured when the installation date is unidentified. However, the guarantee term may vary on the sales term.

## IN-WARRANTY service information

If the defective part has been identified under normal and proper use within the guarantee term, contact your local authorized LS distributor or LS Service center.

## OUT-OF WARRANTY service information

The guarantee will not apply in the following cases, even if the guarantee term has not expired.

- Damage was caused by misuse, negligence or accident.
- Damage was caused by abnormal voltage and peripheral devices malfunction (failure).
- Damage was caused by an earthquake, fire, flooding, lightning, or other natural calamities.
- When LS nameplate is not attached.
- When the warranty period has expired.

## Revision History

No	Date	Edition	Changes
1	2010. 4	First Release	