

Right choice for ultimate yield

LSIS strives to maximize customers' profit in gratitude of choosing us for your partner.

Drive Copy Unit Option Module

SV-iS7, iE5 Series

User Manual



Safety Instructions



- Use this board after read Safety Instruction of this manual carefully before using and follow the instructions exactly.
- Please hand this user manual to end user and trouble shooting manager
- After read this manual, keep it at handy for future reference.
- 사용 전에 '안전상의 주의사항'을 반드시 읽고 정확하게 사용하여 주십시오.
- 본 설명서는 제품을 사용하는 사람이 항상 볼 수 있는 곳에 잘 보관하십시오.

Safety Precaution



First thank you for using our iS7 Drive Copy Unit Option Board!

Please follow the following safety attentions since they are intended to prevent any possible accident and danger so that you can use this product safely and correctly.

Safety attentions may classify into 'Warning' and 'Caution' and their meaning is as following:

Symbol	Meaning
 WARNING	This symbol indicates the possibility of death or serious injury.
 CAUTION	This symbol indicates the possibility of injury or damage to property.

The meaning of each symbol in this manual and on your equipment is as follows.

Symbol	Meaning
	This is the safety alert symbol. Read and follow instructions carefully to avoid dangerous situation.
	This symbol alerts the user to the presence of "dangerous voltage" inside the product that might cause harm or electric shock.

After reading this manual, keep it in the place that the user always can contact. This manual should be given to the person who actually uses the products and is responsible for their maintenance.

WARNING

- **Do not remove the cover while power is applied or the unit is in operation.**
Otherwise, electric shock could occur.
- **Do not run the inverter with the front cover removed.**

⚠ WARNING

Otherwise, you may get an electric shock due to high voltage terminals or charged capacitor exposure.

- **Do not remove the cover except for periodic inspections or wiring, even if the input power is not applied.**

Otherwise, you may access the charged circuits and get an electric shock.

- **Wiring and periodic inspections should be performed at least 10 minutes after disconnecting the input power and after checking the DC link voltage is discharged with a meter (below DC 30V).**

Otherwise, you may get an electric shock.

- **Operate the switches with dry hands.**

Otherwise, you may get an electric shock.

- **Do not use the cable when its insulating tube is damaged.**

Otherwise, you may get an electric shock.

- **Do not subject the cables to scratches, excessive stress, heavy loads or pinching.**

Otherwise, you may get an electric shock.

⚠ CAUTION

- **Install the inverter on a non-flammable surface. Do not place flammable material nearby.**

Otherwise, fire could occur.

- **Disconnect the input power if the inverter gets damaged.**

Otherwise, it could result in a secondary accident and fire.

- **Do not touch the inverter while the input power is applied or after removed. It will remain hot for a couple of minutes.**

Otherwise, you may get bodily injuries such as skin-burn or damage.

- **Do not apply power to a damaged inverter or to an inverter with parts missing even if the installation is complete.**

Otherwise, electric shock could occur.

- **Do not allow lint, paper, wood chips, dust, metallic chips or other foreign matter into the drive.**

Otherwise, fire or accident could occur.

Table of Contents

Safety Precaution	iii
Table of Contents.....	v
1. Introduction	7
2. Communication Standard.....	8
3. Outlook Description.....	9
4. Communication Cable Standard	10
5. Installation	11
5.1 Parameter copy unit ↔ iS7	11
5.2 Parameter copy unit ↔ iE5	11
5.3 PC ↔ Parameter copy unit	12
5.4 PC ↔ parameter copy unit ↔ iS7 and iE5.....	12
6. LED Description	14
7. Menu Description	15
8. Function Description	16
8.1 READ	16
8.2 SEND	19
8.3 PC	22
8.4 VERIFY	23
8.5 INFO	26
9. USB to RS-485 Conversion (Conv) Function	28
10. List of Errors	29

1. Introduction

Parameter copy unit provides following functions.

- Function to save and read/write parameter for iS7 and iE5 type (Total five groups can be saved by making group for total parameters.)
- After installing iS7 and iE5 type machines, same parameters can be changed at the same time.
- Support RS-485 communication with LS AC drive via 'USB to RS-485 communication conversion function'.

2. Communication Standard

Item		Specification		
		iS7 parameter copy unit		
USB communication		Type	USB 2.0 supported (Maximum 12M)	
		Supported OS	Window 98SE/2000/XP	
Copy machine ↔ Inverter	RS-232C	velocity	9600bps (iE5), 19200bps (iS7)	
		Range	Data Bit	8
			Stop Bit	1
			Parity Bit	N
PC ↔ Inverter	RS-485	velocity	1200, 2400, 9600, 19200, 38400 bps	
		Range	Data Bit	7, 8
			Stop Bit	0, 1
			Parity Bit	N, EVEN, ODD
Parameter set available to be saved		Maximum 5 sets		
Memory size		128 Kbyte		
Input power		DC5V inverter internal power or PC USB power		

3. Exterior Description

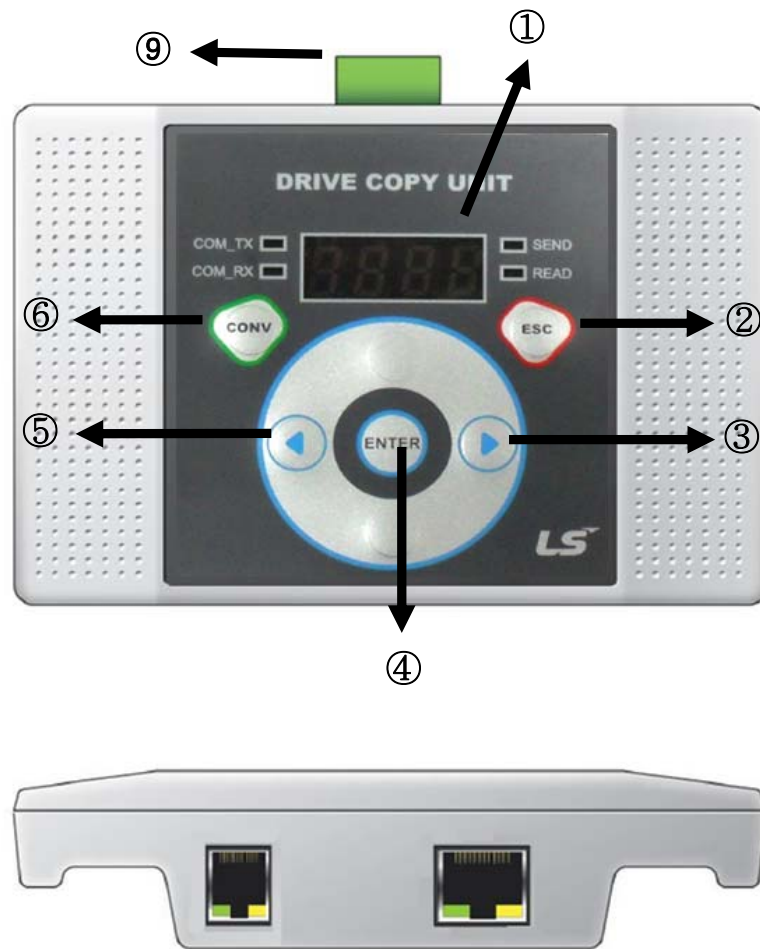

No.	Function
1	Display part (Display current motion.)
2	ESC key (Used when returning to the previous stage)
3	Right arrow key (Used when action is moved)
4	Enter key (Selection and default upload function)
5	Left arrow key (Used when action is moved)
6	RS-485 mode selection key
7	RJ45 connector (8p)
8	USB connection connector (6p)
9	RS-485 connection connector

4. Communication Cable Standard

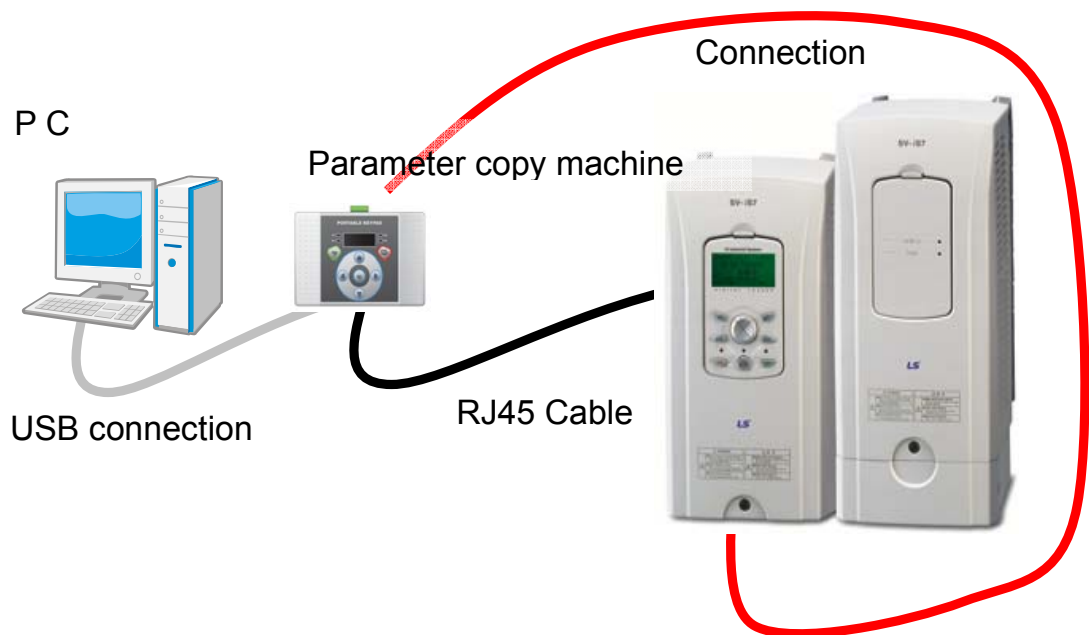

The cable for communicating parameter copy unit is dedicated USB connection cable and universal RJ45 cable.

USB connection cable should be less than 2m cable, and the universal RJ45 cable should be the cable where all pins are connected by 1:1. The LAN cable with 1:1 connection is also available.

⚠ CAUTION

- **Do not disconnect the USB connection cable or RJ45 cable while communicating with the parameter copy unit.**
It may cause trouble and damage.

5. Installation

5.1 Parameter copy unit ↔ iS7

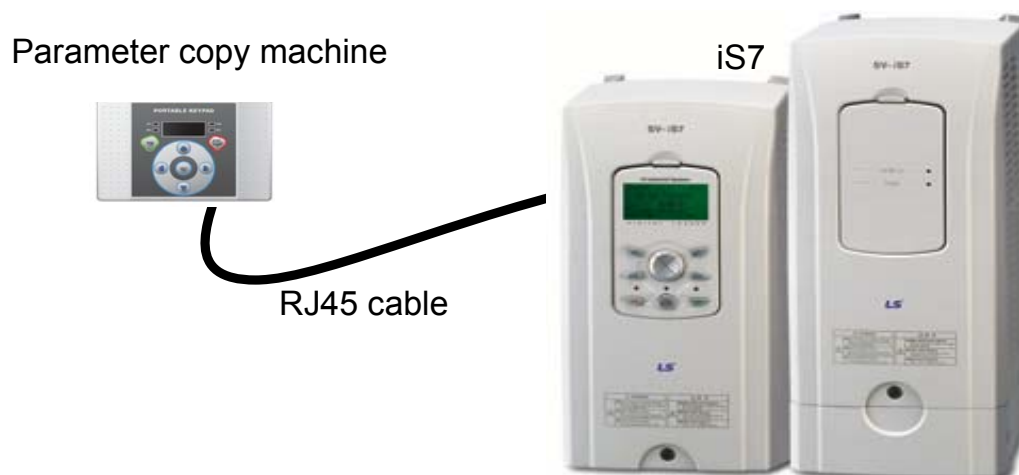

Connect a cable to the parameter copy unit RJ45 connector and connect the other end of cable to the connection part of iS7 keypad.

5.2 Parameter copy unit ↔ iE5

Connect a cable to the parameter copy unit RJ45 connector and connect the other end of cable to the iE5 side board.

Be careful of the direction of the connection when connecting the board and iE5.

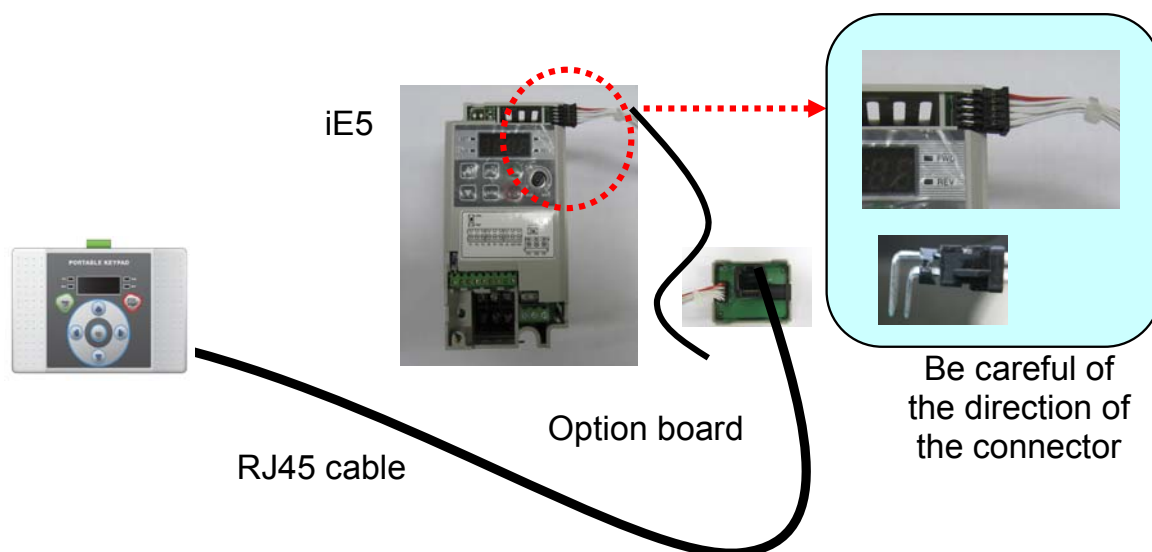

⚠ CAUTION

- Since there is a risk of electric shock when communicating parameter copy unit to iE5, do not turn on the iE5.
- When connecting iE5 and parameter copy unit, there may be “OCT” error. This error is caused by not turning on the iE5.
It will not affect the action in case of parameter copy unit without iE5 power.

5.3 PC ↔ Parameter copy unit

Connect a cable to the parameter copy unit USB connection connector, and connect the other end of cable to the PC.

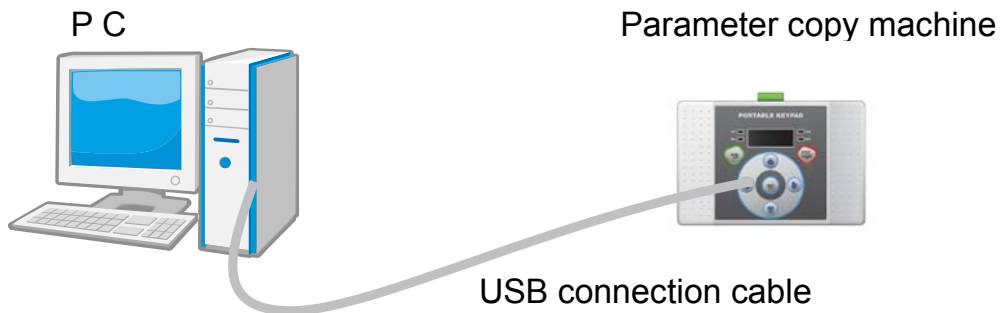
**5.4 PC ↔ parameter copy unit ↔ iS7 and iE5**

Connect parameter copy unit to the PC, and connect iS7 RS-485 terminal, iE5 RS-485 terminal and the parameter copy unit by referring to the connection diagram below.

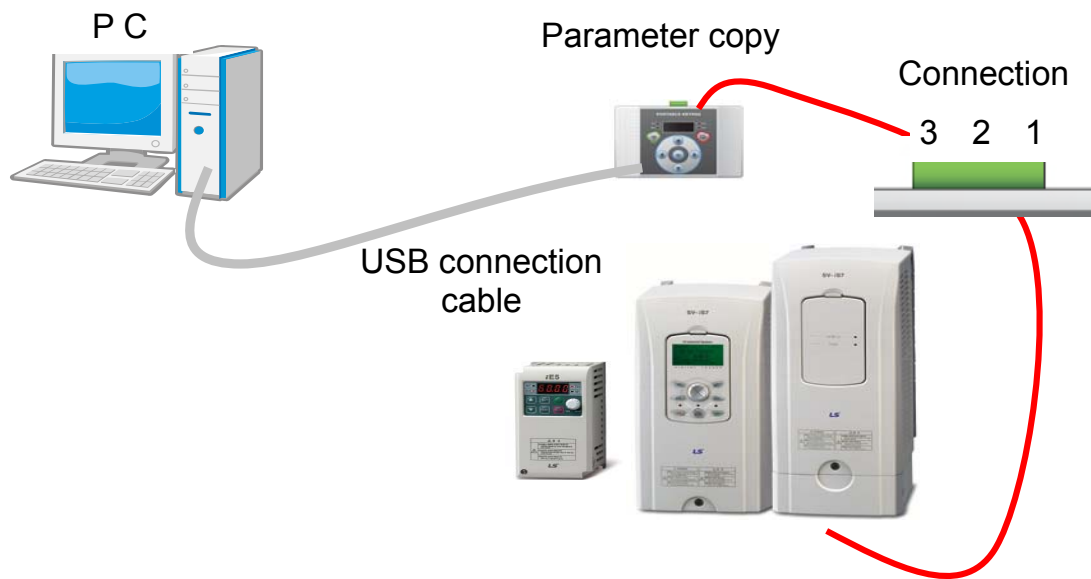

Connection diagram

Pin No.	Signal
1	S+
2	S-
3	

6. LED Description

The parameter copy unit has 4 LEDs. There are COM-TX LED, COM-RX LED, Send LED and Read LED.

The basic features of the LED are as follows.

COM-TX LED	<ul style="list-style-type: none"> ▪ When connecting PC ↔ parameter copy unit, it shows data is being transmitted from parameter copy unit to PC. ▪ When connecting PC ↔ parameter copy unit ↔ inverter, it shows data is being transmitted from inverter to PC via parameter copy unit.
COM-RX LED	<ul style="list-style-type: none"> ▪ When connecting PC ↔ parameter copy unit, it shows data is being transmitted from PC to parameter copy unit. ▪ When connecting PC ↔ parameter copy unit ↔ inverter, it shows data is being transmitted from PC to the inverter via parameter copy unit.
Send LED	<ul style="list-style-type: none"> ▪ It shows data is being transmitted to inverter either iS7 or iE5 connected to the parameter copy unit. ▪ When finding the type and number of inverter connected to the parameter copy unit, it shows data is being transmitted.
Read LED	<ul style="list-style-type: none"> ▪ It shows data is being received from the inverter connected to the parameter copy unit either iS7 or iE5.

7. Menu Description

Parameter copy unit has total five menus.

READ	This is the activity to read parameter saved in the inverter to the parameter copy unit.
SEND	This is the activity to transmit the parameter saved in the parameter copy unit to the inverter.
P C	This is the activity to read parameter saved in the parameter copy unit from the PC or edit the parameter compliant to the specified type and transmit it to the parameter copy unit.
VERIFY	This is the activity to compare the parameter value currently saved in the parameter copy unit and the parameter value of the inverter one by one, and indicate the incorrect value.
INFO	This is the activity to notify the version of the parameter saved in the parameter copy unit. (except iE5)

Move between each menu by pushing arrow button. (right arrow key, left arrow key)

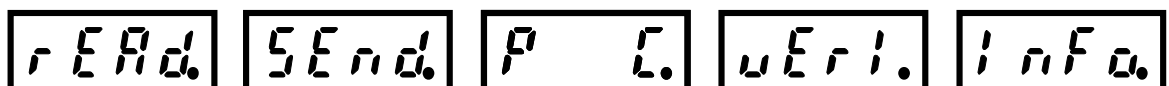

8. Function Description

8.1 READ

This is the activity to read the parameter saved in the inverter to the parameter copy unit.

1. Select read command. Select 'Read' command by using arrow key and push Enter button.

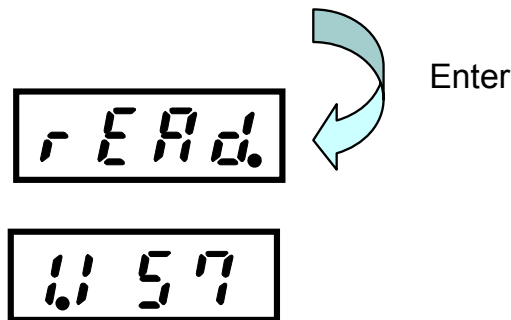

2. Determine whether the value is saved in the memory.



No. 1 memory – No value No. 1 memory – iS7 parameter is saved

3. If the value is saved in the memory, delete the memory value.

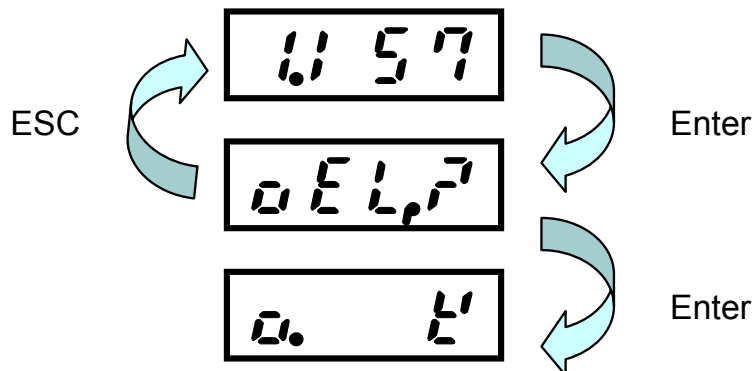

4. If you want to select another memory, move between memories by using right and left keys.

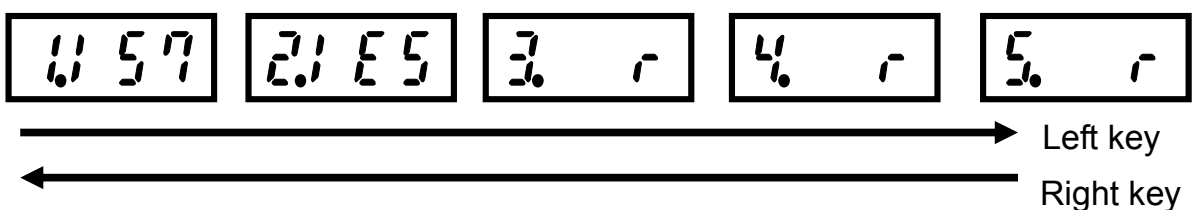

5. If a message saying 'memory is deleted' appears, push ESC. (ESC means returning to the upper menu) The memory value indicates the memory value is empty.

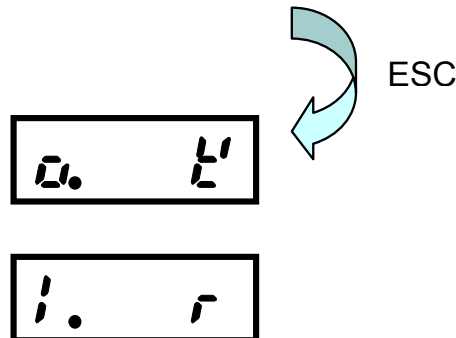

6. Push 'Enter' from the empty memory value to read the parameter.

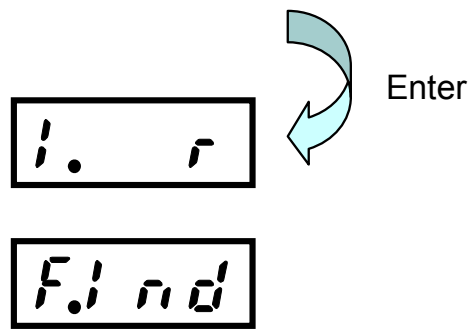

7. If you push 'Enter' from the memory, the parameter copy unit finds the type and number of the inverter connected to the memory. (It searches whether the type of inverter is iS7 or iE5. If it is iE5, what the number of the inverter is.)
- The letter 'Find' is changed as below every one second to search the inverter.
 - It searches the number of iE5, 1 up to 9, and baud rate up to 9600.

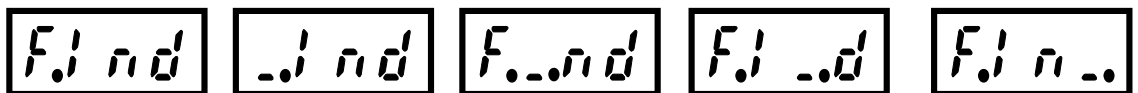

8. If the inverter is found, 'Read' command is executed.
- In case of iS7, it takes 4 seconds, and in case of iE5, it takes 5 seconds.

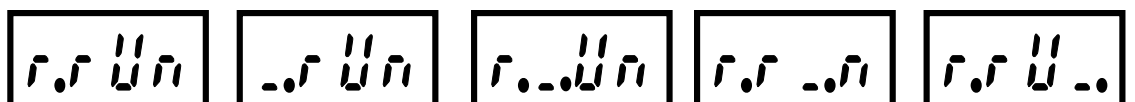

9. 'Read' command is completed, it is displayed as follows.

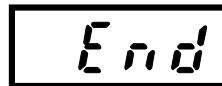

10. If you push ESC button, it returns to the memory selection screen. (At this time, if reading iS7 is finished, iS7 will be displayed, and if reading iE5 is finished, iE5 will be displayed.)

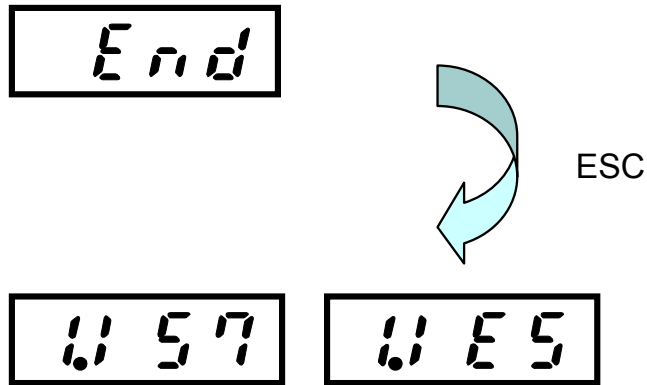

11. If any error occurs during the reading communication, the communication error will be displayed on the screen. At this time, you can remove the error message by pushing ESC button.

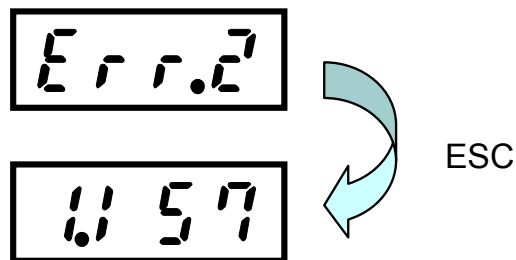

8.2 SEND

This is the activity to transmit the parameter saved in the parameter copy unit to the inverter.

1. Select 'Write' command.

a. After selecting 'Write' command by using arrow key, push 'Enter' button.

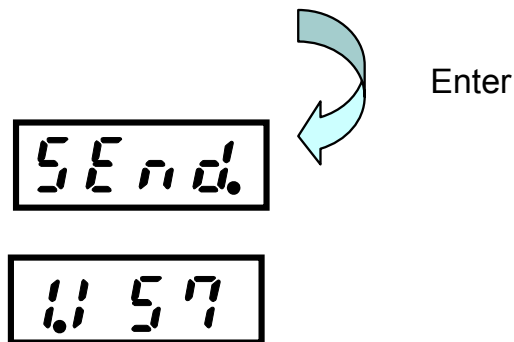

2. Determine whether the value is saved in the memory.



No. 1 memory – No value

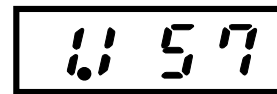

No. 1 memory – i57 parameter is saved

3. If the memory is empty, it displays error message. (Since there is no data to be transmitted.)

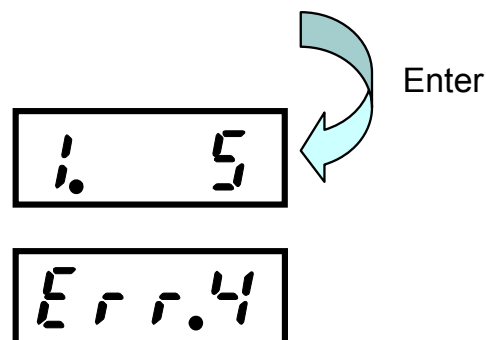

4. If you want to select another memory, move to the memory by using right and left keys.

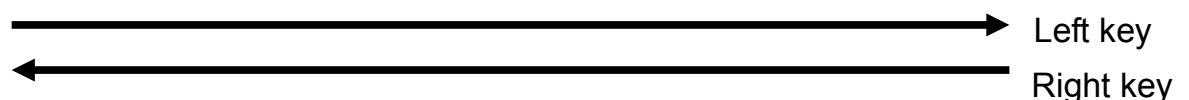

5. Push 'Enter' at the saved memory value to execute the parameter writing. (iS7 is shown as an example. iE5 is same.)

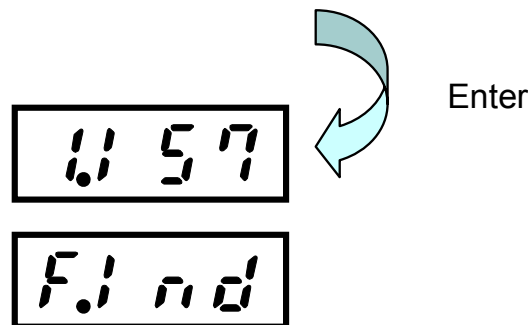

6. If you push 'Enter' at the memory, the parameter copy unit finds the current type and number of the inverter connected to the unit. (It searches whether the inverter is iS7 or iE5. If it is iE5, it searches what is the number of the inverter.)
- The 'Find' letter is changed as follows every on second to search the inverter continuously.
 - In case of the number of iE5, it searches 1 up to 9, and in case of baud rate, it searches up to 9600.

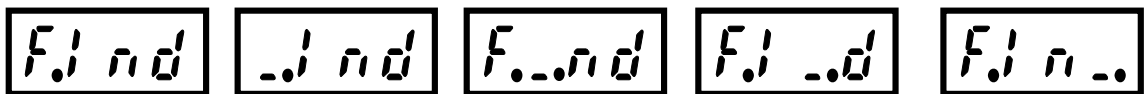

7. If iS7 parameter is written on iE5, it checks that the inverter currently connected is iE5 through 'Find' command and it displays error message.

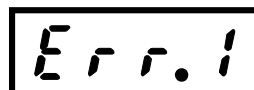

8. If it finds iS7 inverter, then it executes 'Write' command.
- In case of iS7, it takes 4 seconds, and in case of iE5, it takes 5 seconds.

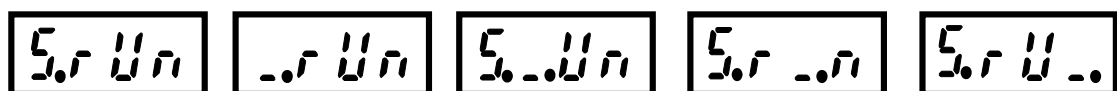

9. If the 'Write' command is finished, it is displayed as follows

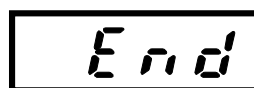

10. Push ESC button to return to the memory selection screen.

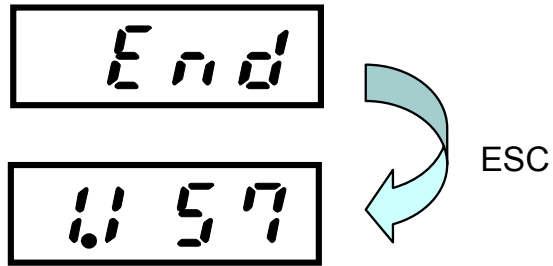

11. If any error occurs during the writing communication, communication error will appear on the screen. At this time, you can remove the error message by pushing ESC button.

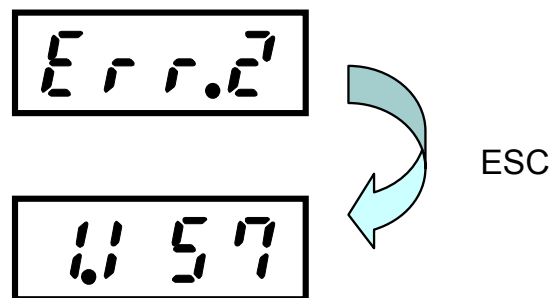

8.3 PC

This is the activity to read parameter saved in the parameter copy unit from PC, or edit the parameter compliant to the required format and transmit the parameter to the parameter copy unit.

1. Select PC command.

- a. Select the PC command by using arrow key and push 'Enter' button.

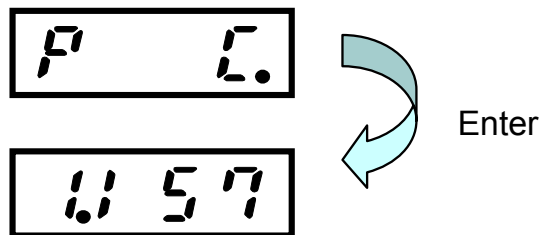

- b. Click 'Enter' to execute PC command regardless of the existence of the value saved in the memory.

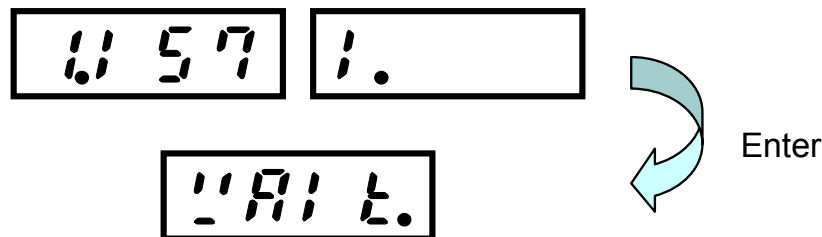

- c. Use PC program to read or write the parameter value.

- i. See appendix for how to use PC program.
- ii. See appendix for communication protocol.

- d. The cases of finishing writing parameter in the PC program are largely divided in two cases.

- i. In case that the memory is full: The previous memory is deleted and new value is saved.
- ii. In case that the memory is empty: The received data value is saved.

- e. The cases of finishing reading parameter in the PC program are largely divided in two cases.

- i. In case that the memory is full: Data you want will be transmitted to the PC.
- ii. In case that the memory is empty: Error code is transmitted to the PC.

8.4 VERIFY

This is the activity to compare the parameter value saved in the parameter copy unit and the parameter value of the inverter one by one and displays wrong value.

1. Select 'Verify' command.

a. Select 'Verify' command by using arrow key and push 'Enter' button.

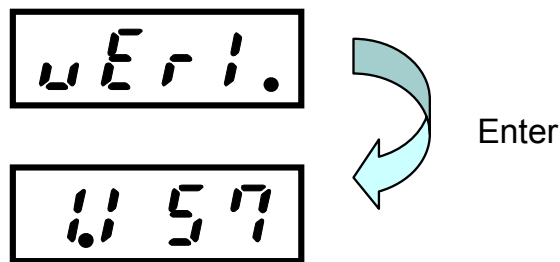

2. Determine whether the value is saved in the memory.



No. 1 memory – No value No. 1 memory – iS7 parameter is saved

3. If there is no value in the memory, it displays error message. (Since there is no data to compare to)

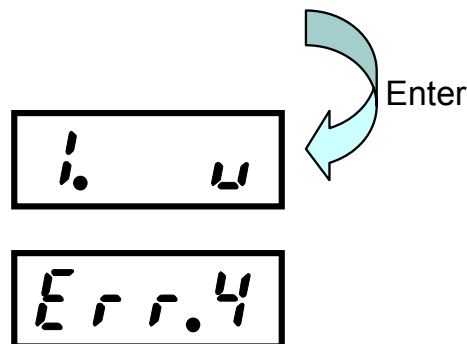

4. If you want to select another memory, move to the memory by using right key and left key.

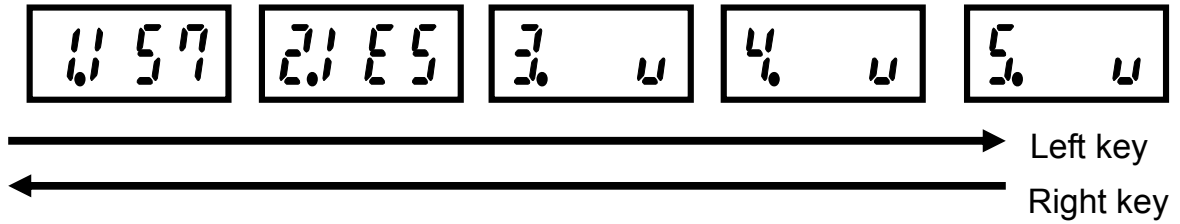

5. Push 'Enter' in the saved memory value to execute parameter verification. (iS7 is displayed as an example. iE5 is also same.)

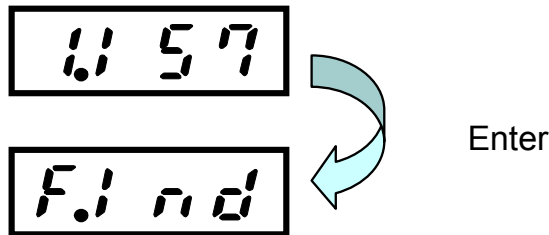

6. If you click 'Enter' from the memory, the parameter copy unit finds the type and number of the inverter currently connected to the unit. (It searches whether the type of inverter is iS7 or iE5. If it is iE5, what the number of the inverter is.)

- While the letter 'Find' is changed every one second, it searches the inverter continuously.
- It searches the number of iE5 up to (1~9), and baud rate up to 9600.



7. If you try to verify the iS7 parameter with iE5, verify that the current connected inverter is iE5 through 'Find' command, and displays error message.



8. If the iS7 inverter is found, execute the 'Verify' command. In case of iS7, it takes 9 seconds, and in case of iE5, it takes 4 seconds.



9. If the 'verify' command is finished, it is displayed as follows. It means all data is same.



10. If you push ESC button, it returns to the memory selection screen.

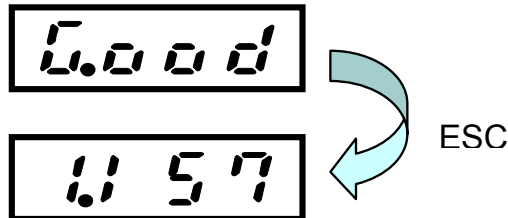

11. If any error occurs during 'verify' communication, the communication error will be displayed on the screen. At this time, you can push ESC button to clear the error message.

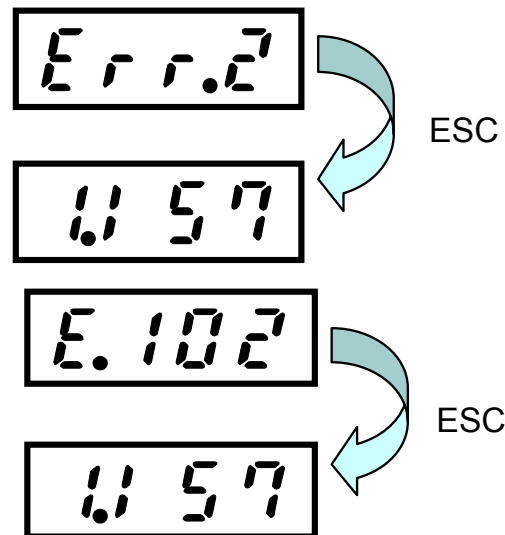

- E.102 means No. 102 communication address is different
 - In case of iS7: Communication address 0h1102 value
 - In case of iE5: Communication address 0hd102 value

12. If the parameter value is different during the verify communication, another parameter address value will be displayed. At this time, you can push ESC button to clear the error.
13. If you want to compare following parameters, push the right button to continue the Verify activity.
14. If there is no data to compare, it displays 'Good' message.

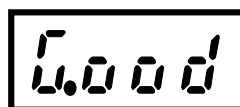

8.5 INFO

This is the activity to indicate the version of parameter saved in the parameter copy unit. (excluding iE5)

1. Select 'Info' command.

Select 'Info' command by using arrow key and click 'Enter' button.

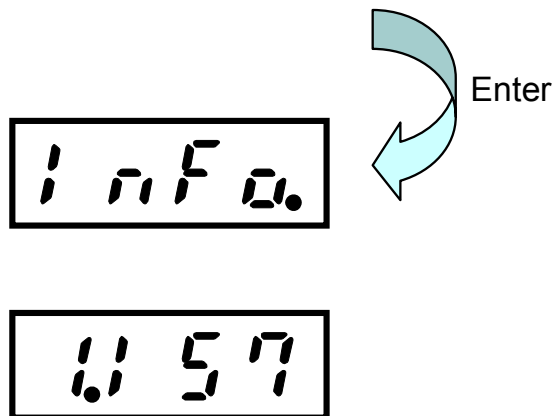

2. It determines whether the value is saved in the memory.

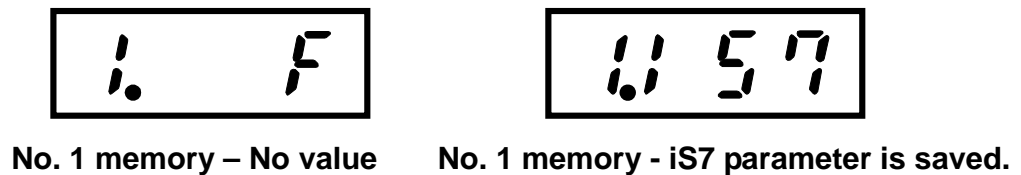

3. If there is no value in the memory, it displays error message. (Since there is no data to read information)

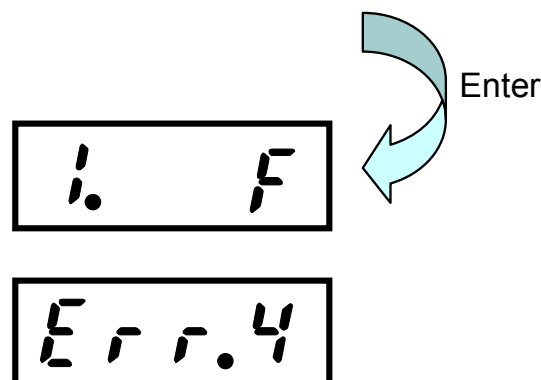

4. If you choose another memory, move to the memory by using the right key and left key.

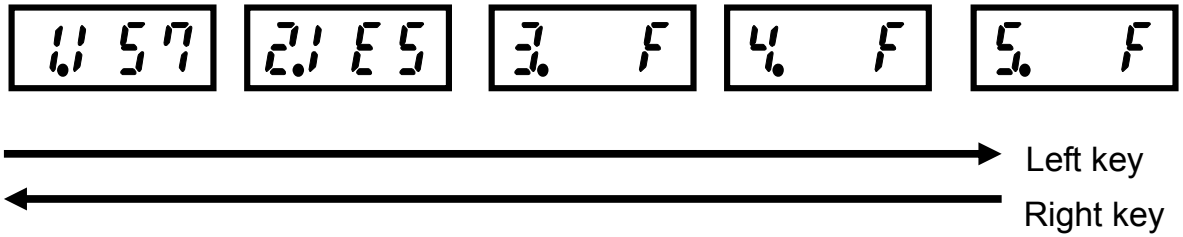

5. Push 'Enter' in the saved memory value to execute the parameter info command. (iS7 is used as an example. In case of iE5, it is fixed at V1.00)

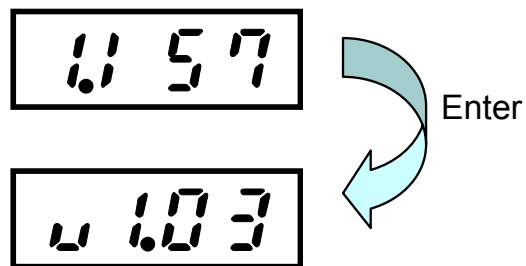

6. Push ESC button to return to the memory selection screen.

9. USB to RS-485 Conversion (Conv) Function

1. See the Appendix 3 to install the driver.
2. If you want to use the Conv function, push ESC to move to the very top menu selection screen.

rEAd. SEnd. P C. uErI. InFa.

3. Push Conv button on the menu selection screen

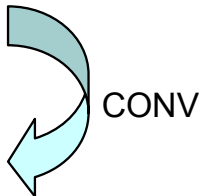
rEAd. SEnd. P C. uErI. InFa. 

Conv

4. Conv mode is changed as below to prepare transmitting and receiving.

Conv Conv' Conv, Conv. Conv Conv'

5. It begins RS-485 communication by using DriveView or other PC programs.
6. After finishing the communication, push Conv button to return to the menu screen.

⚠ CAUTION

If connect the RJ45 cable and the inverter simultaneously during RS-485 communication, it causes communication problem.

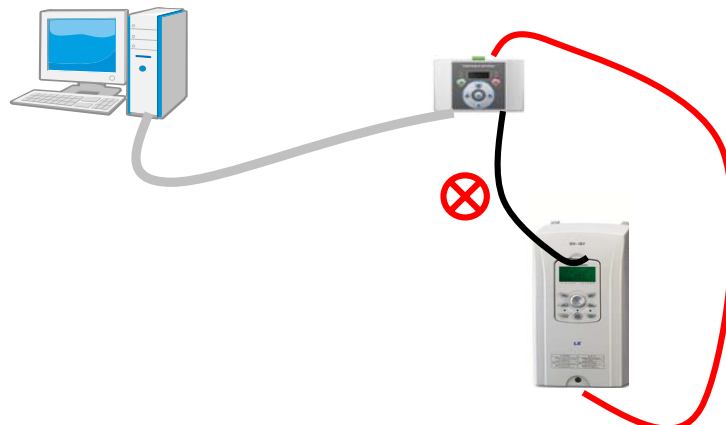

10. List of Errors

Error No.	Name	Description
Err 1	Inverter matching error	If the inverter currently connected is not the type to SEND and Verify through Find command, an error message will appear on the screen.
Err 2	Communication error	If normal communication is not possible due to physical factors (line connection status, noise, etc.) during communication, the communication error will be displayed on the screen.
Err 4	Pparameter non-existence error	Although memory has no value, if you try to execute SEND, Verify, INFO commands, it displays error message on the screen.

APPENDIX A. Segment Mark

(1) Number Mark

0	1	2	3	4	5	6	7	8	9
---	---	---	---	---	---	---	---	---	---

(2) Alphabet Mark

A	B	C	D	E	F	G	H	I	J
K	L	M	N	O	P	Q	R	S	T
U	V	W	X	Y	Z				

APPENDIX B. Modbus-RTU Protocol

1. Write Protocol is as following:

Function Code#06 (Preset Single Register, Unit: byte)

Request	Response
Field Name	Field Name
Slave Address	Slave Address
0h06	0h06
Register Address Hi	Register Address Hi
Register Address Lo	Register Address Lo
Preset Data Hi	Preset Data Hi
Preset Data Lo	Preset Data Lo
CRC Lo	CRC Lo
CRC Hi	CRC Hi

2. Read Protocol is as following:

Function Code#04 (Read Input Register, Unit: byte)

Request	Response
Field Name	Field Name
Slave Address	Slave Address
Function Code	Function Code
Starting Address High Rank	Bite Number
Starting Address Low Rank	Data Hi (Register 30009)
# of Points Hi	Data Lo (Register 30009)
# of Points Lo	CRC Lo
CRC Lo	CRC Hi
CRC Hi	

3. Communication velocity is fixed to 19200bps, data bit 8, stop bit 1 and parity bit n.

4. Error Code is as following:

Exception Code
01:ILLEGAL Function Code
02:ILLEGAL DATA ADDRESS
03: ILLEGAL DATA VALUE
06: SLAVE DEVICE BUSY
Response
Slave Address
Function Code ^(Note1)
Exception Code
CRC Lo
CRC Hi

5. For example, the followings are responded when a command demanding to write a value for D1000 of telephone exchange number 1's iS7 is sent to PC (It is also true to street numbers ineffective to other iS7).

0h01
0h86
0h02
CRC Lo
CRC Hi

APPENDIX C. How to use PC program

1. PC program button description

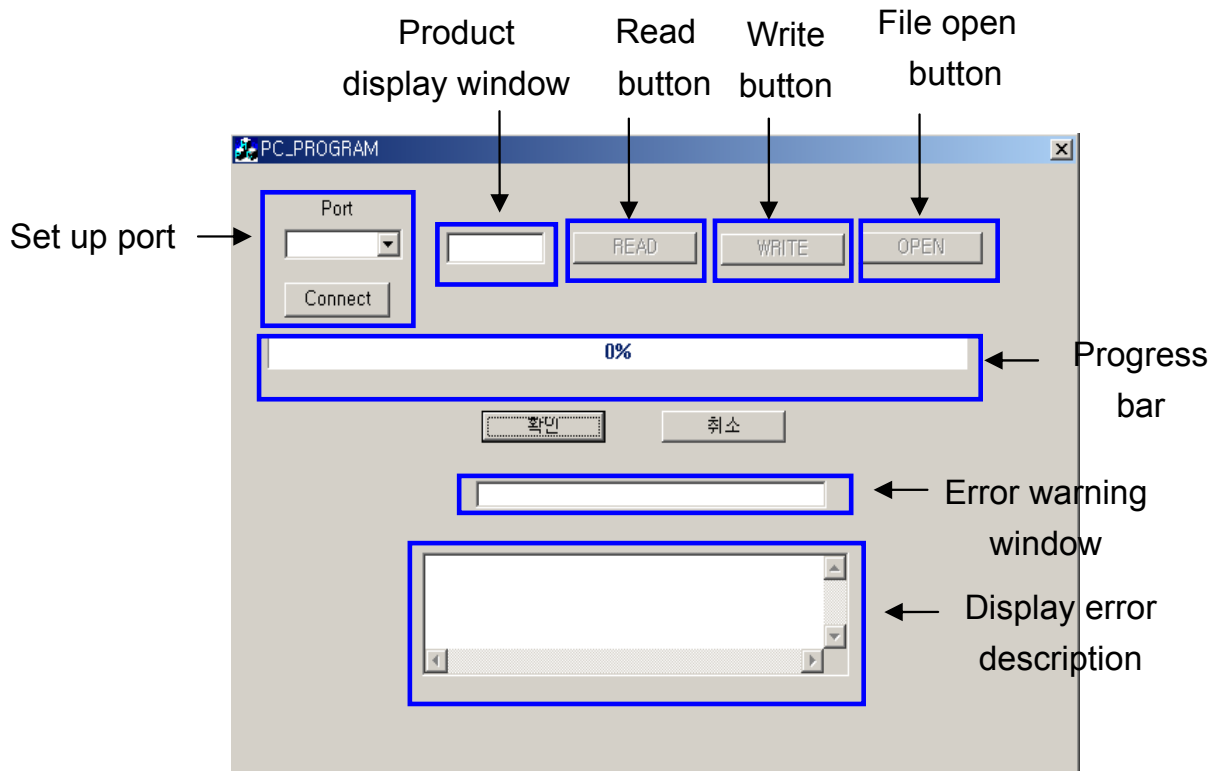

- **Set up port**

Find the port connecting parameter copy unit and PC to set up the connection between PC and parameter copy unit.

- **Product display window**

If you push READ or WRITE button and transmission begins, the product name will be displayed on the product display window.

- **Read button**

Use this button when reading parameter information saved in the parameter copy unit

- **Write button**

Use this button to edit the parameter information from PC and revise the file for the parameter copy unit.

- **File open button**

Open the parameter button revised in PC

- **Progress bar**
Display a window to notify the progressing status of the file transmission
- **Confirm, Cancel**
Use this button to terminate the program.
- **Error warning window**
If any value is changed during writing, “check error” will appear.
- **Display error description**
If any value is changed during writing, it displays changed value and previous value.

(3) How to set up the parameter copy unit

1. Push the right key for three times or push the left key for two times at the initial status of the parameter copy unit to move to the PC mode status.

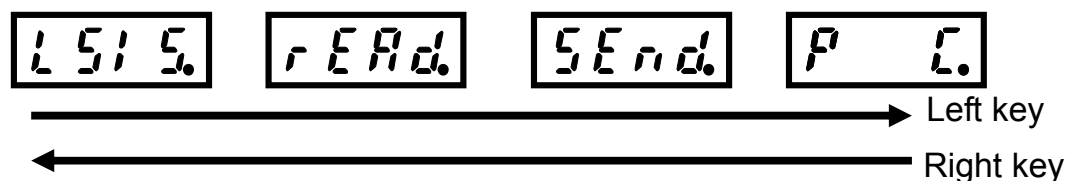

If you click 'Enter' for two times at PC status, it moves to “WAlT” status. (It is same both when memory value is empty and saved.)

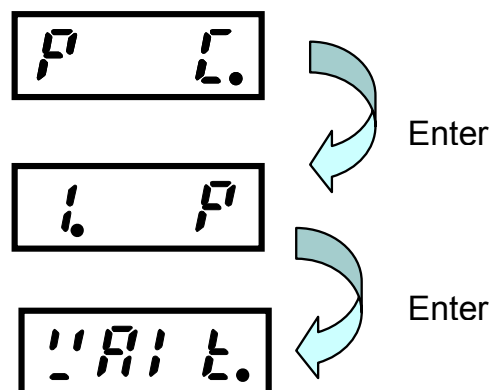

2. After writing by using PC program, push ESC key then it will displays as below. Example) iS7

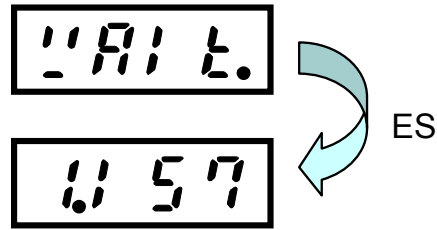

3. How to upload and download parameter. (Parameter copy unit → PC)

Before you connect USB, install the provided drive program and connect the USB.

Go to Start-Settings-Control panel and click 'System' and click the device manager on the hardware tab.

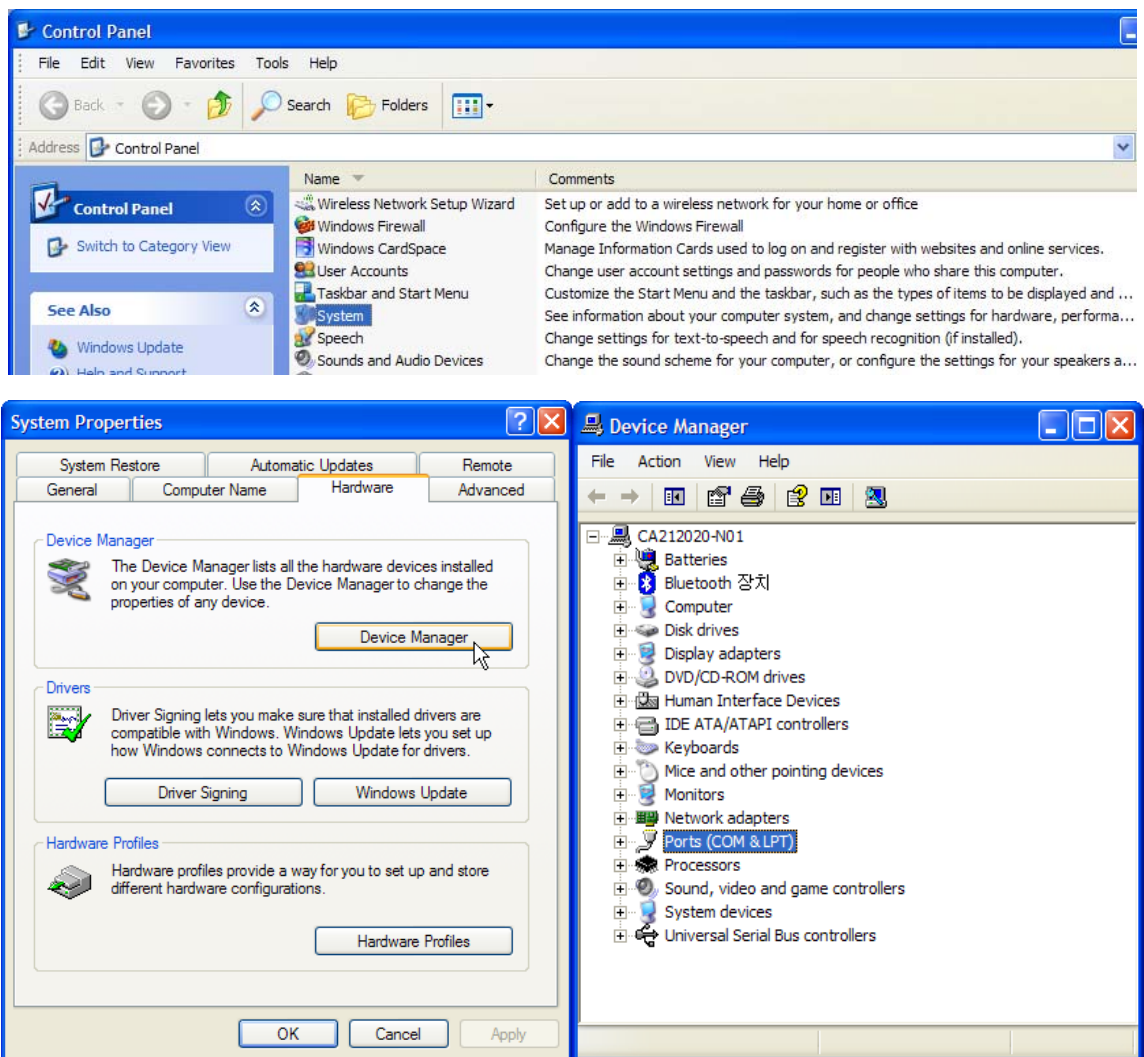

If you click '+' at the port, you will find which number port is connected to the parameter copy unit and PC.

If you move the mouse over the port, the COMx ports will be listed. Find and select the port connected to the PC and parameter copy unit.

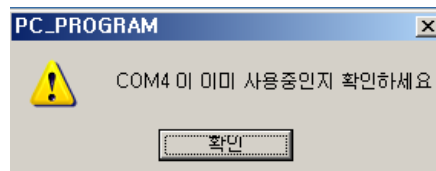
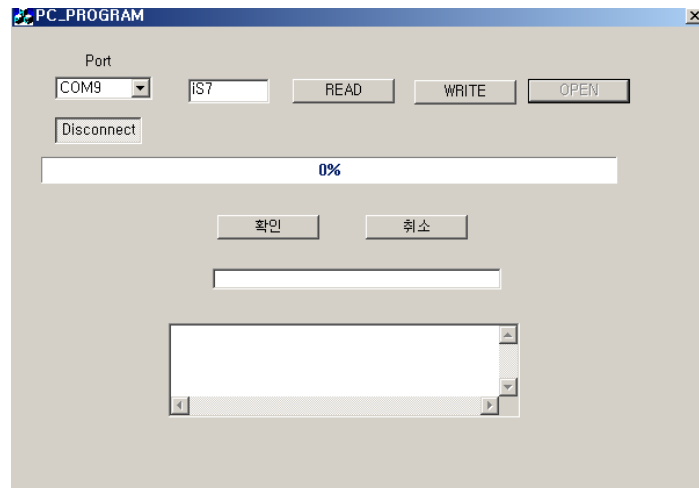
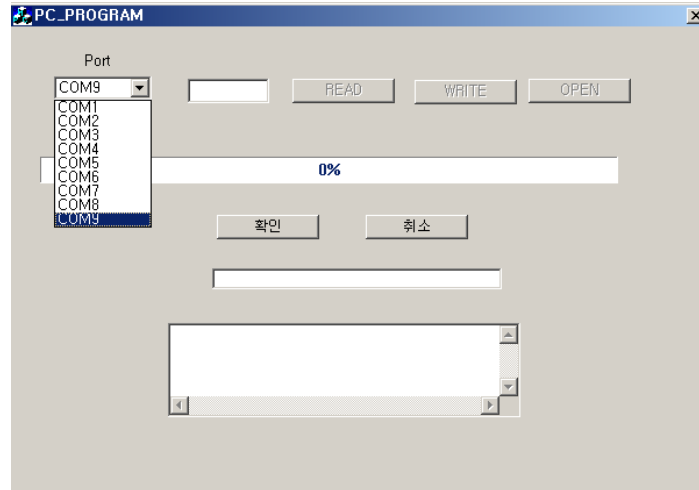

Open the basically provided file “iS7 (or iE5).csv” and click ‘Open’ button.

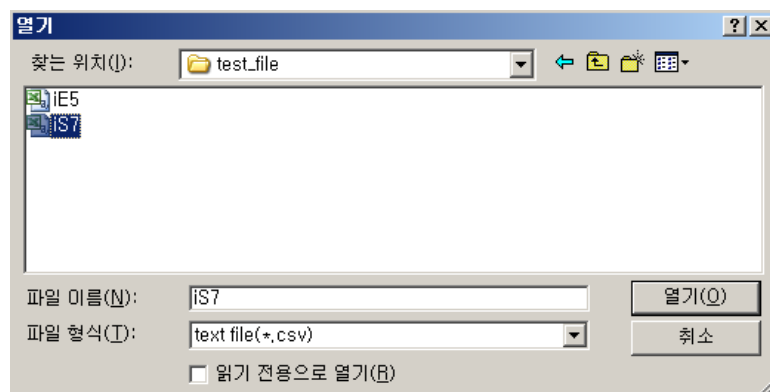

If you open the file, “WRITE” and “READ” buttons are activated. The description about the READ and WRITE is as follows.

- **READ button:**

Use this button when reading parameter information about the parameter copy unit. (Parameter copy unit → PC)

- **WRITE button:**

Use this button to write the parameter for the parameter copy unit from the basically provided file. (PC → parameter copy unit)

If you click READ or WRITE, then the file is transmitted as follows.

If the progress bar is not moved even you click READ or WRITE button, check out whether the parameter copy unit is in the PC waiting mode status.

(2. Please see how to set up parameter copy unit)

If you want to cancel it during transmission, click '**Confirm**' or '**Cancel**' button to terminate it, and transmit it again.

If the transmission is not completed, any value won't be written on the parameter copy unit.

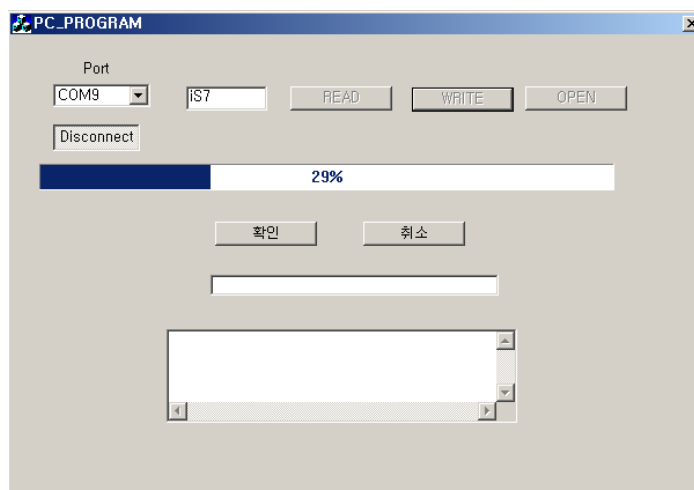

If you use the parameter copy unit first time, or use another product at the existing memory bank, you have to execute 'Write' command first, and then execute 'Read' command.

If not, a following message will appear.

If the message below will appear, push 'Confirm' until "The transmission is completed" message appear. Then it returns back to the status of (3).

(4) **Parameter edition function**

1. If you want to edit the transmitted parameter, or edit the basically provided "*.csv" file, you should open the file you want to edit.

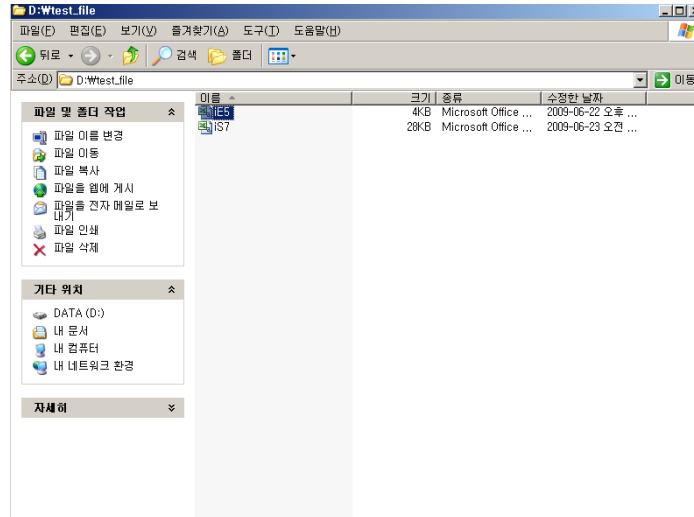

2. If you open the file, it is composed of number, address, data and short description about the address.

A	B	C	D	E
ID:01	Addr:D0FF	Data:0000	DRV00점프 코드	
ID:01	Addr:D100	Data:0050	DRV01목표주파수	
ID:01	Addr:D101	Data:0100	DRV02토크 지형	
ID:01	Addr:D102	Data:0001	DRV03가속 시간	
ID:01	Addr:D103	Data:0000	DRV04감속 시간	
ID:01	Addr:D104	Data:1000	DRV05운전 지형	
ID:01	Addr:D105	Data:2000	DRV06주파수설정	
ID:01	Addr:D203	Data:0000	DRV07토크 지형	
ID:01	Addr:D204	Data:0000	DRV08제어 모드	
ID:01	Addr:D205	Data:0000	DRV09토크 제어	
ID:01	Addr:D206	Data:0000	DRV10조그주파수	
ID:01	Addr:D207	Data:0000	DRV11조그운전 가속시간	
ID:01	Addr:D208	Data:0500	DRV12조그운전 감속시간	
ID:01	Addr:D209	Data:0010	DRV13전동기용량	
ID:01	Addr:D20A	Data:0050	DRV14토크부스트	
ID:01	Addr:D20B	Data:0010	DRV15정방향토크 부스트	
ID:01	Addr:D20C	Data:0050	DRV16역방향토크 부스트	
ID:01	Addr:D20D	Data:0000	DRV17기저주파수	
ID:01	Addr:D20E	Data:1000	DRV18시작주파수	
ID:01	Addr:D20F	Data:6000	DRV19최대주파수	
ID:01	Addr:D210	Data:6000	DRV20속도 단위	
ID:01	Addr:D211	Data:0050	BAS00점프 코드	
ID:01	Addr:D212	Data:0000	BAS01보조속 지형	
ID:01	Addr:D213	Data:0050	BAS02보조속 지형	
ID:01	Addr:D214	Data:0050	BAS03보조속 지형	
ID:01	Addr:D215	Data:0000	BAS04제 2 운전	
ID:01	Addr:D216	Data:0100	BAS05제2 주파수	
ID:01	Addr:D217	Data:0000	BAS06제2토크	
ID:01	Addr:D218	Data:0180	BAS07V/F 패턴	
ID:01	Addr:D219	Data:0600	BAS08가감속 기준	
ID:01	Addr:D21A	Data:0000	BAS09시간 단위 설정	
ID:01	Addr:D21B	Data:0150	BAS10입력전원 주파수	
ID:01	Addr:D21C	Data:0000	BAS11전동기 극수	
ID:01	Addr:D21D	Data:0000	BAS12정격 슬립 속도	
ID:01	Addr:D21E	Data:0500	BAS13전동기 정격전류	
ID:01	Addr:D21F	Data:0000	BAS14무부하 전류	
ID:01	Addr:D220	Data:0000	BAS15전동기 정격전압	
ID:01	Addr:D221	Data:0000	BAS16전동기 효율	
ID:01	Addr:D222	Data:0000	BAS17부하 관성비	
ID:01	Addr:D223	Data:0000	BAS18파워 표시 조정	
ID:01	Addr:D224	Data:0100	BAS19입력전원 전압	
ID:01	Addr:D225	Data:0000	BAS41사용자 주파수 1	
ID:01	Addr:D226	Data:0010	BAS42사용자 전압 1	
ID:01	Addr:D227	Data:0001	BAS43사용자 주파수 2	
ID:01	Addr:D228	Data:0004	BAS44사용자 전압 2	
ID:01	Addr:D229	Data:0233	BAS45사용자 주파수 3	
ID:01	Addr:D22A	Data:0011	BAS46사용자 전압 3	

3. Find the address of the parameter you want and edit the data value only. All of them are ASCII value except Input Output address

(COM51~86) and PLC(APO60~74). Edit the data of the value you want. However, if you modify the address or ID here, "Func error!!" message appear or it may cause an error when verifying the parameter unit.

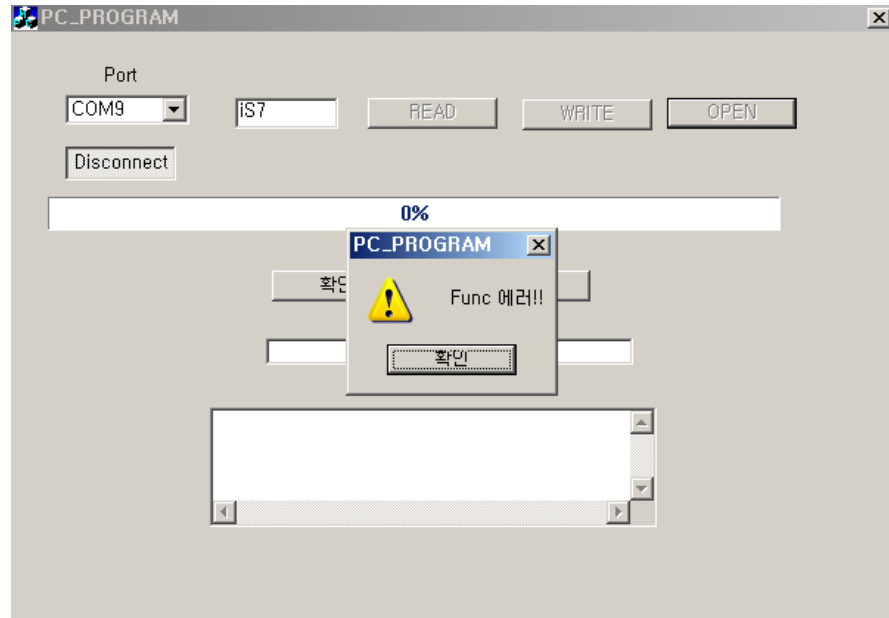



LS values every single customer.
Quality and service come first at LSIS.
Always at your service, standing for our customers.

www.lsis.biz

LS Industrial Systems

10310001065

■ HEAD OFFICE

Address: LS tower, 1026-6, Hoge-dong, Dongan-gu, Anyang-si, Gyeonggi-do 431-848, Korea
<http://eng.lsis.biz>

■ LS Industrial Systems Europe B.V. >> Amsterdam, Netherland

Address: 1st FL., Tupolevlaan 48, 1119NZ Schiphol-Rijk, The Netherlands
Tel: 31-20-654-1420 Fax: 31-20-654-1429 e-mail: junshickp@lsis.biz

■ LS Industrial Systems (Middle East) FZE Office >> Dubai, UAE

Address: LOB 19 Jafza View Tower Room 205, Jebel Ali Free Zone, P.O.Box 114216, Dubai, UAE.
Tel: 971-4-886-5360 Fax: 971-4-886-5361 e-mail: jungyongl@lsis.biz

■ Dalian LS Industrial Systems Co., Ltd. >> Dalian, China

Address: No. 15 Liaohexi 3-Road, Economic and Technical Development Zone, Dalian 116600, China
Tel: 86-411-8273-7777 Fax: 86-411-8730-7560 e-mail: lixk@lsis.com.cn

■ LS Industrial Systems Wuxi Co., Ltd. >> Wuxi, China

Address: 102-A National High & New Tech Industrial Development Area, Wuxi, Jiangsu 214028, China
Tel: 86-510-8534-6666 Fax: 86-510-522-4078 e-mail: xuhg@lsis.com.cn

■ LS-VINA Industrial Systems Co., Ltd. >> Hanoi, Vietnam

Address: Nguyen Khe, Dong Anh, Ha Noi, Vietnam
Tel: 84-4-882-0222 Fax: 84-4-882-0220 e-mail: srjo@lsisvina.com

■ LS-VINA Industrial Systems Co., Ltd. >> Hochiminh, Vietnam

Address: 41 Nguyen Thi Minh Khai Str. Yoco Bldg 4th FL., Hochiminh City, Vietnam
Tel: 84-8-3822-7941 Fax: 84-4-3822-7942 e-mail: sbpark@lsisvina.com

■ LS Industrial Systems Tokyo Office >> Tokyo, Japan

Address: 16th FL., Higashi-Kan, Akasaka Twin Tower 17- 22, 2-chome, Akasaka, Minato-ku, Tokyo 107-8470, Japan
Tel: 81-3-3582-9128 Fax: 81-3-3582-2667 e-mail: jschuna@lsis.biz

■ LS Industrial Systems Shanghai Office >> Shanghai, China

Address: Room E-G, 12th FL., Huamin Empire Plaza, No. 726, West Yan'an Road, Shanghai 200050, China
Tel: 86-21-5237-9977 (609), FAX: 89-21-5237-7191 e-mail: jinhk@lsis.com.cn

■ LS Industrial Systems Beijing Office >> Beijing, China

Address: B-tower 17th FL., Beijing Global Trade Center B/D, No.36, BeiSanHuanDong-Lu, DongCheng-District, Beijing 100013, China
Tel: 86-10-5825-6025, 7 Fax: 86-10-5825-6026 e-mail: cuixiaorong@lsis.com.cn

■ LS Industrial Systems Guangzhou Office >> Guangzhou, China

Address: Room 1403, 14th FL., New Poly Tower, 2 Zhongshan Liu Road, Guangzhou, China
Tel: 86-20-8326-6764 Fax: 86-20-8326-6287 e-mail: linsz@lsis.biz

■ LS Industrial Systems Chengdu Office >> Chengdu, China

Address: 12th FL., Guodong Building, No.52 Jindun Road, Chengdu, 610041, P.R. China
Tel: 86-28-8612-9151 Fax: 86-28-8612-9236 e-mail: yangcf@lsis.com.cn

■ LS Industrial Systems Qingdao Office >> Qingdao, China

Address: 7B40, Haixin Guangchang Shenye B/D B, No.9, Shandong Road, Qingdao 26600, China
Tel: 86-532-8501-6568 Fax: 86-532-583-3793 e-mail: lirj@lsis.com.cn

■ 본사 (Drive 사업부): 경기도 안양시 동안구 호계동 1026-6
LSE타워 B/D (우)431-080

신속한 서비스 접수, 든든한 기술상담
고객상담센터 한국어대사나 1544-2080

■ 구입 문의

서울영업	TEL: (02)2034-4611~18	FAX: (02)2034-4622
부산영업	TEL: (051)310-6855~60	FAX: (051)310-6851
대구영업	TEL: (053)603-7741~7	FAX: (053)603-7788
서부영업 (광주)	TEL: (062)510-1885~91	FAX: (062)526-3262
서부영업 (대전)	TEL: (042)820-4240~42	FAX: (042)820-4298
서부영업 (전주)	TEL: (063)271-4012	FAX: (063)271-2613

■ 기술문의

고객상담센터	TEL: (전국어대사나) 1544-2080	FAX: (041)550-8600
동현산전(안양)	TEL: (031)479-4785~6	FAX: (031)479-4784
나노오토메이션(대전)	TEL: (042)636-8015	FAX: (042)636-8016
신광ENG(부산)	TEL: (051)319-1051	FAX: (051)319-1052
씨에스티(부산)	TEL: (051)311-0337	FAX: (051)311-0338
에이엔디시스템(부산)	TEL: (051)317-1237	FAX: (051)317-1238

■ 교육신청 연락처:

LS산전 연수원	TEL: (043)268-2631~2	FAX: (043)268-4384
서울 교육장	TEL: (031)689-7101	FAX: (031)689-7113
부산 교육장	TEL: (051)310-6860	FAX: (051)310-6851
대구 교육장	TEL: (053)603-7744	FAX: (053)603-7788

■ A/S 문의

서울 고객지원팀	TEL: (031)689-7112	FAX: (031)689-7113
천안 고객지원팀	TEL: (041)550-8308~9	FAX: (041)554-3949
부산 고객지원팀	TEL: (051)310-6922~3	FAX: (051)310-6851
대구 고객지원팀	TEL: (053)603-7751~4	FAX: (053)603-7788
광주 고객지원팀	TEL: (062)510-1883,92	FAX: (062)526-3262

■ 서비스 지정점

명산전(서울)	TEL: (02)462-3053	FAX: (02)462-3054
TP시스템(서울)	TEL: (02)895-4803~4	FAX: (02)6264-3545
신진시스템(안산)	TEL: (031)508-9606	FAX: (031)508-9608
우진산전(의정부)	TEL: (031)877-8273	FAX: (031)878-8279
성원M&S(인천)	TEL: (032)588-3750	FAX: (032)588-3751
태영시스템(대전)	TEL: (042)670-7363	FAX: (042)670-7364
파란자동차(천안)	TEL: (041)579-8308	FAX: (041)579-8309
디에스산전(창주)	TEL: (043)237-4816	FAX: (043)237-4817
지이티시스템(구미)	TEL: (054)465-2304	FAX: (054)465-2315
대영시스템(대구)	TEL: (053)564-4370	FAX: (053)564-4371
서진산전(울산)	TEL: (052)227-0335	FAX: (052)227-0337
동남산전(창원)	TEL: (055)265-0371	FAX: (055)265-0373
정석시스템(광주)	TEL: (062)526-4151	FAX: (062)526-4152
코리아산전(익산)	TEL: (063)835-2411~5	FAX: (063)831-1411

● LS Industrial Systems constantly endeavors to improve its product so that information in this manual is subject to change without notice.
● 본 설명서에 기재된 제품은 예고 없이 단종이나 제품이 변동이 있을 수 있으므로 구입시 반드시 확인 바랍니다. ● 제품 사용 중 이상이 생겼거나 불편한 점은 LS산전으로 문의 바랍니다.