



Advanced simple Inverter

iMaster-U1

CAUTION

Thank you for purchasing our iMaster-U1 of inverters.

- This product is designed to drive a three-phase induction motor. Read through this instruction manual and be familiar with the handling procedure for correct use.
- Improper handling might result in incorrect operation, a short life, or even a failure of this product as well as the motor.
- Deliver this manual to the end user of this product. Keep this manual in a safe place until this product is discarded.
- For instructions on how to use an optional device, refer to the instruction and installation manuals for that optional device.

ADT Co., Ltd.



Copyright © 2017 ADT Co., Ltd.

All rights reserved.

No part of this publication may be reproduced or copied without prior written permission from ADT Co., Ltd.

All products and company names mentioned in this manual are trademarks or registered trademarks of their respective holders.

The information contained herein is subject to change without prior notice for improvement.



Table of Contents

Preface	2	Chapter 5 FUNCTION CODES	5-1
Safety precautions.....	3	5.1 Function Code Tables	5-1
Chapter 1 BEFORE USING THE INVERTER....	1-1	5.2 Details of Function Codes	5-18
1.1 Acceptance Inspection	1-1	Chapter 6 TROUBLESHOOTING	6-1
1.2 External Views.....	1-2	6.1 If an Alarm Code Appears on the LED Monitor	6-1
Chapter 2 MOUNTING AND WIRING OF THE INVERTER.....	2-1	6.2 If an Abnormal Pattern Appears on the LED Monitor while No Alarm Code is Displayed	6-2
2.1 Operating Environment	2-1	Chapter 7 MAINTENANCE AND INSPECTION..	7-1
2.2 Installing the Inverter	2-1	7.1 Daily Inspection.....	7-1
2.3 Wiring	2-2	7.2 Periodic Inspection.....	7-1
2.3.1 Removing and mounting the terminal block covers.....	2-2	7.3 List of Periodical Replacement Parts	7-3
2.3.2 Terminal arrangement and screw specifications	2-3	7.4 Inquiries about Product and Guarantee	7-4
2.3.3 Recommended wire sizes	2-5	7.4.1 When making an inquiry	7-4
2.3.4 Wiring precautions	2-6	7.4.2 Product warranty	7-4
2.3.5 Wiring for main circuit terminals and grounding terminals	2-7	Chapter 8 SPECIFICATIONS.....	8-1
2.3.6 Wiring for control circuit terminals... ..	2-10	8.1 Standard Models	8-1
2.3.7 Setting up the jumper switches	2-17	8.1.1 Single-phase 200 V class series	8-1
Chapter 3 OPERATION USING THE KEYPAD .	3-1	8.1.2 Three-phase 400 V class series	8-2
3.1 Names and Functions of Keypad Components	3-1	8.2 Terminal Specifications	8-3
3.2 Overview of Operation Modes	3-2	8.2.1 Terminal functions.....	8-3
Chapter 4 RUNNING THE MOTOR	4-1	8.2.2 Connection diagram in operation by external signal inputs	8-3
4.1 Test Run.....	4-1	8.3 Protective Functions	8-5
4.1.1 Checking prior to powering on.....	4-1	8.4 External Dimensions.....	8-8
4.1.2 Powering ON and checking	4-1		
4.1.3 Preparation before a test run Configuring function code data.....	4-2		
4.1.4 Test run.....	4-3		
4.2 Operation	4-3		

Preface

Thank you for purchasing our iMaster-U1 of inverters.

This product is designed to drive a three-phase induction motor. Read through this instruction manual and be familiar with proper handling and operation of this product.

Improper handling might result in incorrect operation, a short life, or even a failure of this product as well as the motor.



Have this manual delivered to the end user of this product. Keep this manual in a safe place until this product is discarded.

The materials are subject to change without notice. Be sure to obtain the latest editions for use.

Safety precautions

Read this manual thoroughly before proceeding with installation, connections (wiring), operation, or maintenance and inspection. Ensure you have sound knowledge of the device and familiarize yourself with all safety information and precautions before proceeding to operate the inverter.

Safety precautions are classified into the following two categories in this manual.

 WARNING	Failure to heed the information indicated by this symbol may lead to dangerous conditions, possibly resulting in death or serious bodily injuries.
 CAUTION	Failure to heed the information indicated by this symbol may lead to dangerous conditions, possibly resulting in minor or light bodily injuries and/or substantial property damage.

Failure to heed the information contained under the CAUTION title can also result in serious consequences. These safety precautions are of utmost importance and must be observed at all times.

Application

 WARNING
<ul style="list-style-type: none">• iMaster-U1 is designed to drive a three-phase induction motor. Do not use it for single-phase motors or for other purposes. Fire or an accident could occur.• iMaster-U1 may not be used for a life-support system or other purposes directly related to the human safety.• Though iMaster-U1 is manufactured under strict quality control, install safety devices for applications where serious accidents or material losses are foreseen in relation to the failure of it. An accident could occur.

Installation

 WARNING
<ul style="list-style-type: none">• Install the inverter on a nonflammable material such as metal. Otherwise fire could occur.• Do not place flammable matter nearby. Doing so could cause fire.

CAUTION

- Do not support the inverter by its terminal block cover during transportation.
Doing so could cause a drop of the inverter and injuries.
- Prevent lint, paper fibers, sawdust, dust, metallic chips, or other foreign materials from getting into the inverter or from accumulating on the heat sink.
Otherwise, a fire or an accident might result.
- Do not install or operate an inverter that is damaged or lacking parts.
Doing so could cause fire, an accident or injuries.
- Do not get on a shipping box.
- Do not stack shipping boxes higher than the indicated information printed on those boxes.
Doing so could cause injuries.

Wiring

WARNING

- When wiring the inverter to the power source, insert a recommended molded case circuit breaker (MCCB) or residual-current-operated protective device (RCD)/earth leakage circuit breaker (ELCB) (with overcurrent protection) in the path of power lines. Use the devices within the recommended current range.
- Use wires in the specified size.
- When wiring the inverter to the power supply of 500 kVA or more, be sure to connect an optional AC reactor (ACR).
Otherwise, fire could occur.
- Do not use one multicore cable in order to connect several inverters with motors.
- Do not connect a surge killer to the inverter's output (secondary) circuit.
Doing so could cause fire.
- Be sure to connect the grounding wires without fail.
Otherwise, electric shock or fire could occur.
- Qualified electricians should carry out wiring.
- Be sure to perform wiring after turning the power off.
- Ground the inverter in compliance with the national or local electric code.
Otherwise, electric shock could occur.
- Be sure to perform wiring after installing the inverter body.
Otherwise, electric shock or injuries could occur.
- Ensure that the number of input phases and the rated voltage of the product match the number of phases and the voltage of the AC power supply to which the product is to be connected.
Otherwise fire or an accident could occur.
- Do not connect the power source wires to output terminals (U, V, and W).

WARNING

- Generally, control signal wires are not reinforced insulation. If they accidentally touch any of live parts in the main circuit, their insulation coat may break for any reasons. In such a case, an extremely high voltage may be applied to the signal lines. Make a complete remedy to protect the signal line from contacting any hot high voltage lines.
Doing so could cause an accident or electric shock.

CAUTION

- Wire the three-phase motor to terminals U, V, and W of the inverter, aligning phases each other.
Otherwise injuries could occur.
- The inverter, motor and wiring generate electric noise. Take care of malfunction of the nearby sensors and devices. To prevent the motor from malfunctioning, implement noise control measures.
Otherwise an accident could occur.

Operation

WARNING

- Be sure to install the terminal block cover before turning the power on. Do not remove the cover while power is applied.
Otherwise electric shock could occur.
- Do not operate switches with wet hands.
Doing so could cause electric shock.
- If the retry function has been selected, the inverter may automatically restart and drive the motor depending on the cause of tripping.
(Design the machinery or equipment so that human safety is ensured after restarting.)
- If the stall prevention function (current limiter), automatic deceleration, and overload prevention control have been selected, the inverter may operate at an acceleration/deceleration time or frequency different from the set ones. Design the machine so that safety is ensured even in such cases.
Otherwise an accident could occur.
- The STOP key is only effective when function setting (Function code F02) has been established to enable the STOP key. Prepare an emergency stop switch separately. If you disable the STOP key priority function and enable operation by external commands, you cannot emergency-stop the inverter using the STOP key on the built-in keypad.
- If an alarm reset is made with the operation signal turned on, a sudden start will occur. Ensure that the operation signal is turned off in advance.
Otherwise an accident could occur.

WARNING

- If you enable the "restart mode after momentary power failure" (Function code F14 = 4 or 5), then the inverter automatically restarts running the motor when the power is recovered. (Design the machinery or equipment so that human safety is ensured after restarting.)
- If you set the function codes wrongly or without completely understanding this instruction manual, the motor may rotate with a torque or at a speed not permitted for the machine.

An accident or injuries could occur.

- Do not touch the inverter terminals while the power is applied to the inverter even if the inverter stops.

Doing so could cause electric shock.

CAUTION

- Do not turn the main circuit power on or off in order to start or stop inverter operation.
Doing so could cause failure.
- Do not touch the heat sink or braking resistor because they become very hot.
Doing so could cause burns.
- Setting the inverter to high speeds is easy. Before changing the frequency (speed) setting, check the specifications of the motor and machinery.
- The brake function of the inverter does not provide mechanical holding means.

Injuries could occur.

Maintenance and inspection, and parts replacement

WARNING

- Turn the power off and wait for at least five minutes before starting inspection. Further, check that the LED monitor is unlit.
Otherwise, electric shock could occur.
- Maintenance, inspection, and parts replacement should be made only by qualified persons.
- Take off the watch, rings and other metallic matter before starting work.
- Use insulated tools.

Otherwise, electric shock or injuries could occur.

Disposal

CAUTION

- Handle the inverter as an industrial waste when disposing of it.
Otherwise injuries could occur.

Others

WARNING

- Never attempt to modify the inverter.
Doing so could cause electric shock or injuries.

GENERAL PRECAUTIONS

Drawings in this manual may be illustrated without covers or safety shields for explanation of detail parts. Restore the covers and shields in the original state and observe the description in the manual before starting operation.

Chapter 1 BEFORE USING THE INVERTER

1.1 Acceptance Inspection

Unpack the package and check that:

- (1) An inverter and instruction manual (brief manual) are contained in the package.
- (2) The inverter has not been damaged during transportation—there should be no dents or parts missing.
- (3) The inverter is the model you ordered. You can check the model name and specifications on the main nameplate. (Main and sub nameplates are attached to the inverter and are located as shown on the next page.)



(a) Main Nameplate

(b) Sub Nameplate

Figure 1.1 Nameplates

TYPE: Type of inverter

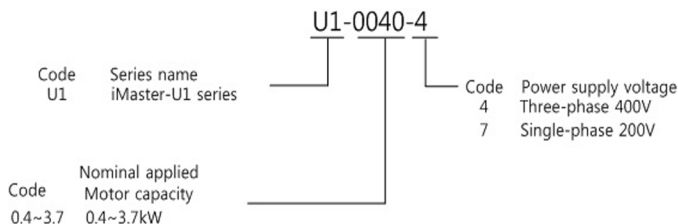

SOURCE: Number of input phases (three-phase: 3PH, single-phase: 1PH), input voltage, input frequency, input current

OUTPUT: Number of output phases, rated output capacity, rated output voltage, output frequency range, rated output current, and overload capacity

SER. No.: Product number

A 7 5 AD 715 1 0003 AA

7 5 — Production month

7 — Production year: Last digit of year

1.2 External Views

(1) External views

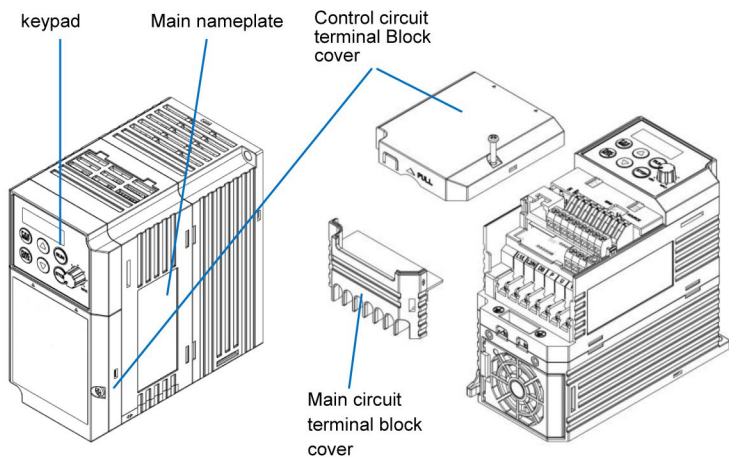

[U1-0040-7]

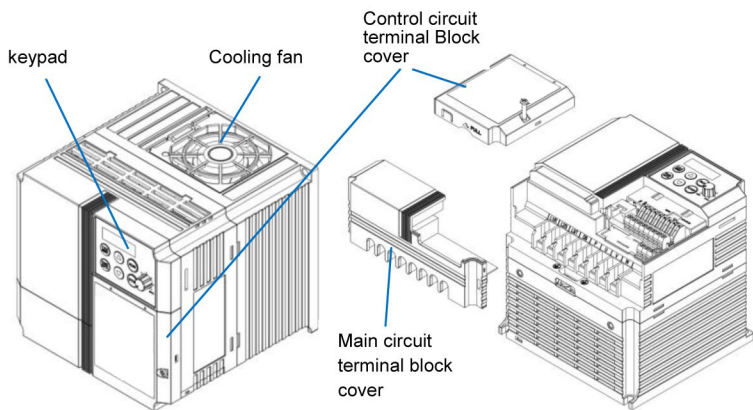

[U1-0370-4]

(2) Wiring section

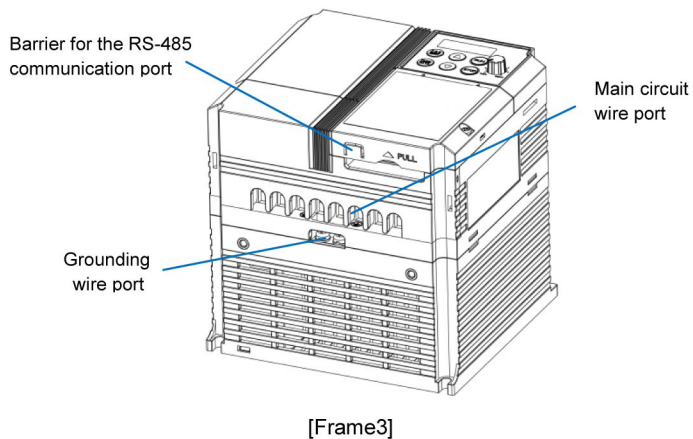
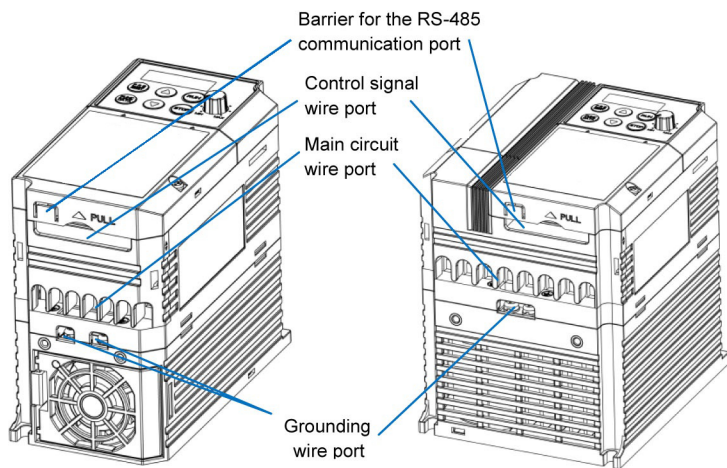

Chapter 2 MOUNTING AND WIRING OF THE INVERTER

2.1 Operating Environment

Install the inverter in an environment that satisfies the requirements listed in Table 2.1.

Table 2.1 Environmental Requirements

Item	Specifications
Site location	Indoors
Ambient temperature	-10 to +50°C (IP20) (Note 1)
Relative humidity	5 to 95% (No condensation)
Atmosphere	The inverter must not be exposed to dust, direct sunlight, corrosive gases, flammable gas, oil mist, vapor or water drops. (Note 2) The atmosphere can contain only a low level of salt. (0.01 mg/cm ² or less per year) The inverter must not be subjected to sudden changes in temperature that will cause condensation to form.
Altitude	1,000 m max. (Note 3)
Atmospheric pressure	86 to 106 kPa
Vibration	3 mm (Max. amplitude) 2 to less than 9 Hz 9.8 m/s ² 9 to less than 20 Hz 2 m/s ² 20 to less than 55 Hz 1 m/s ² 55 to less than 200 Hz

Table 2.2 Output Current Derating Factor in Relation to Altitude

Altitude	Output current derating factor
1000 m or lower	1.00
1000 to 1500 m	0.97
1500 to 2000 m	0.95
2000 to 2500 m	0.91
2500 to 3000 m	0.88

(Note 1) When inverters are mounted side-by-side without any gap between them, the ambient temperature should be within the range from -10 to +40°C.

(Note 2) Do not install the inverter in an environment where it may be exposed to cotton waste or moist dust or dirt which will clog the heat sink in the inverter. If the inverter is to be used in such an environment, install it in the panel of your system or other dustproof containers.

(Note 3) If you use the inverter in an altitude above 1000 m, you should apply an output current derating factor as listed in Table 2.2.

2.2 Installing the Inverter

(1) Mounting base

The temperature of the heat sink may rise up to approx. 90°C during operation of the inverter, so the inverter should be mounted on a base made of material that can withstand temperatures of this level.

 WARNING
Install the inverter on a base made of metal or other non-flammable material. A fire may result with other material.

(2) Clearances

Ensure that the minimum clearances indicated in Figure 2.1 are maintained at all times. When installing the inverter in the panel of your system, take extra care with ventilation inside the panel as the temperature around the inverter tends to increase.

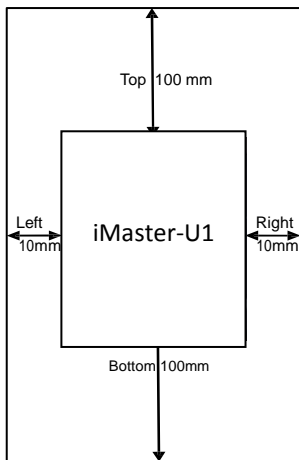

Figure 2.1 Mounting Direction and Required Clearances

When mounting two or more inverters

When mounting two or more inverters in the same unit or panel, basically lay them out side by side. As long as the ambient temperature is 40°C or lower, inverters can be mounted side by side without any clearance between them. When mounting the inverters necessarily, one above the other be sure to separate them with a partition plate or the like so that any heat radiating from an inverter will not affect the one(s) above.

(3) Mounting direction

Secure the inverter to the mounting base with four screws or bolts (M4) so that the iMaster-U1 logo faces outwards. Tighten those screws or bolts perpendicular to the mounting base.

Note

Do not mount the inverter upside down or horizontally. Doing so will reduce the heat dissipation efficiency of the inverter and cause the overheat protection function to operate, so the inverter will not run.

⚠ CAUTION

Prevent lint, paper fibers, sawdust, dust, metallic chips, or other foreign materials from getting into the inverter or from accumulating on the heat sink.

This may result in a fire or accident.

2.3 Wiring

Follow the procedure below. (In the following description, the inverter has already been installed.)

2.3.1 Removing and mounting the terminal block covers

- (1) Loosen the screw securing the control circuit terminal block cover.
- (2) Insert your finger in the cutout (near "PULL") in the bottom of the control circuit terminal block cover, then pull the cover towards you.
- (3) Hold both sides of the main circuit terminal block cover between thumb and forefinger and slide it towards you.
- (4) After performing wiring, mount the main circuit terminal block cover and control circuit terminal block cover in the reverse order of removal.

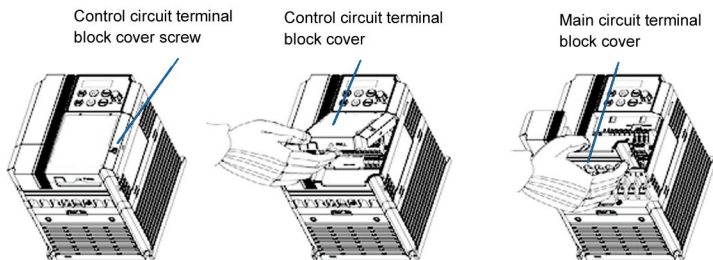

[Removing the Terminal Block Covers]

2.3.2 Terminal arrangement and screw specifications

The figures below show the arrangement of the main and control circuit terminals which differ according to inverter type. The two terminals prepared for grounding, which are indicated by the symbol G in Figures A to C, make no distinction between the power supply side (primary circuit) and the motor side (secondary circuit).

(1) Arrangement of the main circuit terminals

Table 2.3 Main Circuit Terminals

Power supply voltage	Nominal applied motor (kW)	Inverter type	Terminal screw size	Tightening torque (N·m)	Refer to:
Three-phase 400 V	0.4	U1-0040-4	M4	1.2	Fig A
	0.75	U1-0075-4			
	1.5	U1-0150-4			
	2.2	U1-0220-4			
	3.7	U1-0370-4			
Single-phase 200 V	0.4	U1-0040-7	M3	0.5	Fig B
	0.75	U1-0075-7			
	1.5	U1-0150-7	M4	1.5	Fig C
	2.2	U1-0220-7			

Figure A

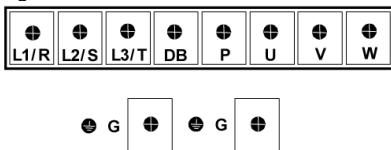

Figure B

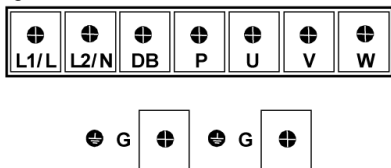
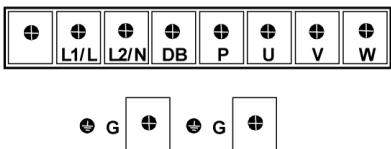

Figure C



(2) Arrangement of the control circuit terminals (common to all JAUGHFI!! %a cXYgL.....)

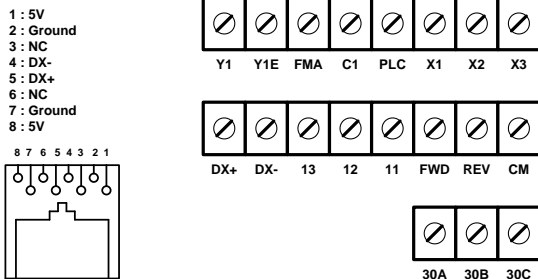

Table 2.4 Control Circuit Terminals

Terminal symbol	Screwdriver (Shape of tip, B x A) Thickness of tip: B	Allowable wire size	Bare wire length L	Ferrule terminal Opening dimension in the terminal block W H
First row in the box [Y1~X3]	Flat screwdriver (0.6 x 3.5 mm)	AWG22 to AWG14 (0.34 to 2.1 mm ²)	4.5 to 5 mm	5 (W) x 2.5 (H) mm
Other than the above	Flat screwdriver (0.6 x 3.5 mm)	AWG24 to AWG14 (0.25 to 2.1 mm ²)	5 to 6 mm	2.3 (W) x 2.5 (H) mm

Table 2.5 Recommended Ferrule Terminals

Screw size	Wire size	Type (216-)			
		With insulated collar		Without insulated collar	
		Short type	Long type	Short type	Long type
M2	AWG24 (0.25 mm ²)	321	301	151	131
	AWG22 (0.34 mm ²)	322	302	152	132
M2 or M2.5	AWG20 (0.50 mm ²)	221	201	121	101
	AWG18 (0.75 mm ²)	222	202	122	102

The length of bared wires to be inserted into ferrule terminals is 5.0 mm or 8.0 mm for the short or long type, respectively.

The following crimping tool is recommended: Variocrimp 4 (Part No. 206-204).

2.3.3 Recommended wire sizes

Table 2.6 lists the recommended wire sizes. The recommended wire sizes for the main circuit terminals for an ambient temperature of 50°C are indicated for two types of wire: HIV single wire (for the maximum allowable temperature 75°C) .

Table 2.6 Recommended Wire Sizes

Power supply voltage	Nominal applied motor (kW)	Inverter type	Recommended wire size (mm ²) ^{*1}			Control circuit
			Main circuit			
			Main circuit power input [L1/R, L2/S, L3/T] [L1/L, L2/N] Grounding [⏚G]	Inverter output [U, V, W]	Braking resistor [P, DB]	
			w/o DCR			
Three-phase 400 V	0.4	U1-0040-4	2.0(2.0)			0.5
	0.75	U1-0075-4				
	1.5	U1-0150-4				
	2.2	U1-0220-4				
	3.7	U1-0370-4				
Single-phase 200 V	0.4	U1-0040-7	2.0(2.0)	2.0(2.0)	2.0 (2.5)	
	0.75	U1-0075-7				
	1.5	U1-0150-7	2.0(3.5)			
	2.2	U1-0220-7	5.5(5.5)			

*1 Use crimp terminals covered with an insulated sheath or insulating tube. Recommended wire sizes are for HIV/IV (PVC in the EU).

2.3.4 Wiring precautions

Follow the rules below when performing wiring for the inverter.

- (1) Make sure that the source voltage is within the rated voltage range specified on the nameplate.
- (2) Be sure to connect the power wires to the main circuit power input terminals L1/R, L2/S and L3/T (for three-phase voltage input) or L1/L and L2/N (for single-phase voltage input) of the inverter. If the power wires are connected to other terminals, the inverter will be damaged when the power is turned on.
- (3) Always connect the grounding terminal to prevent electric shock, fire or other disasters and to reduce electric noise.
- (4) Use crimp terminals covered with insulated sleeves for the main circuit terminal wiring to ensure a reliable connection.
- (5) Keep the power supply wiring (primary circuit) and motor wiring (secondary circuit) of the main circuit, and control circuit wiring as far away as possible from each other.

WARNING

- When wiring the inverter to the power source, insert a recommended molded case circuit breaker (MCCB) or residual-current-operated protective device (RCD)/earth leakage circuit breaker (ELCB) (with overcurrent protection) in the path of power lines. Use the devices within the related current range.
- Use wires in the specified size.
Otherwise, fire could occur.
- Do not use one multicore cable in order to connect several inverters with motors.
- Do not connect a surge killer to the inverter's output (secondary) circuit.
Doing so could cause fire.
- Be sure to connect the grounding wires without fail.
Otherwise, electric shock or fire could occur.
- Qualified electricians should carry out wiring.
- Be sure to perform wiring after turning the power off.
- Ground the inverter in compliance with the national or local electric code.
Otherwise, electric shock could occur.
- Be sure to perform wiring after installing the inverter body.
Otherwise, electric shock or injuries could occur.
- Ensure that the number of input phases and the rated voltage of the product match the number of phases and the voltage of the AC power supply to which the product is to be connected.
Otherwise, fire or an accident could occur.
- Do not connect the power source wires to output terminals (U, V, and W).

2.3.5 Wiring for main circuit terminals and grounding terminals

Follow the procedure below. Figure 2.3 illustrates the wiring procedure with peripheral equipment.

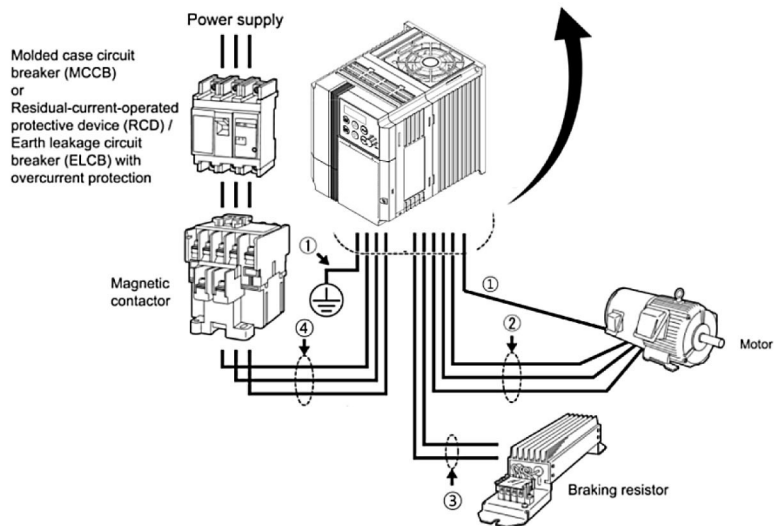
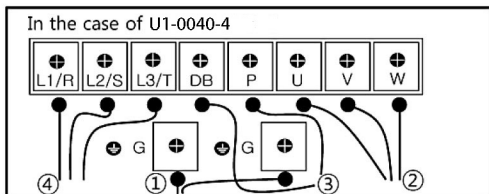
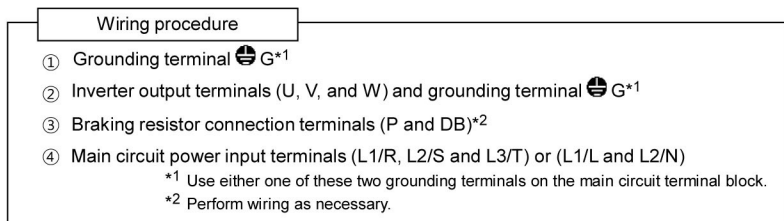

Figure 2.3 Wiring Procedure for Peripheral Equipment

The wiring procedure for the U1-0040-4 is given below as an example. For other inverter types, perform wiring in accordance with their individual terminal arrangement.

① Grounding terminal (⚡G)

Be sure to ground either of the two grounding terminals for safety and noise reduction. It is stipulated by the Electric Facility Technical Standard that all metal frames of electrical equipment must be grounded to avoid electric shock, fire and other disasters.

Grounding terminals should be grounded as follows:

- 1) Ground the inverter in compliance with the national or local electric code.
- 2) Connect a thick grounding wire with a large surface area. Keep the wiring length as short as possible.

② Inverter output terminals, U, V, W and grounding terminal (⚡G)

- 1) Connect the three wires of the three-phase motor to terminals U, V, and W, aligning phases each other.
- 2) Connect the grounding wire of terminals U, V, and W to the grounding terminal (⚡G).

- Note** - The wiring length between the inverter and motor should not exceed 50 m. If it exceeds 50 m, it is recommended that an output circuit filter (option) be inserted.
- Do not use one multicore cable to connect several inverters with motors.

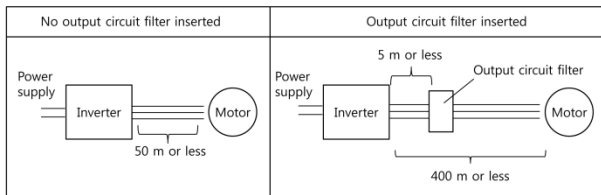

Note

- Do not connect a phase-advancing capacitor or surge absorber to the inverter's output lines (secondary circuit).
- If the wiring length is long, the stray capacitance between the wires will increase, resulting in an outflow of the leakage current. It will activate the overcurrent protection, increase the leakage current, or will not assure the accuracy of the current display. In the worst case, the inverter could be damaged.

Note Driving 400 V series motor

- If a thermal relay is installed in the path between the inverter and the motor to protect the motor from overheating, the thermal relay may malfunction even with a wiring length shorter than 50 m. In this situation, add an output circuit filter (option) or lower the carrier frequency (Function code F26: Motor sound (Carrier frequency)).
- If the motor is driven by a PWM-type inverter, surge voltage that is generated by switching the inverter component may be superimposed on the output voltage and may be applied to the motor terminals. Particularly if the wiring length is long, the surge voltage may deteriorate the insulation resistance of the motor. Consider any of the following measures.
 - Use a motor with insulation that withstands the surge voltage.
 - Connect an output circuit filter (option) to the output terminals (secondary circuits) of the inverter.
 - Minimize the wiring length between the inverter and motor (10 to 20 m or less).

③ Braking resistor terminals, P and DB

- 1) Connect terminals P and DB of a braking resistor (option) to terminals P and DB on the main circuit terminal block.
- 2) Arrange the inverter and braking resistor to keep the wiring length to 5 m or less and twist the two wires or route them together in parallel.

④ Main circuit power input terminals, L1/R, L2/S, and L3/T (for three-phase voltage input) or L1/L and L2/N (for single-phase voltage input)

- 1) For safety, make sure that the molded case circuit breaker (MCCB) or magnetic contactor (MC) is turned off before wiring the main circuit power input terminals.
- 2) Connect the main circuit power supply wires (L1/R, L2/S and L3/T or L1/L and L2/N) to the input terminals of the inverter via an MCCB or residual-current-operated protective device (RCD)/earth leakage circuit breaker (ELCB)*, and MC if necessary.

It is not necessary to align phases of the power supply wires and the input terminals of the inverter with each other.

* With overcurrent protection

Tip

It is recommended that a magnetic contactor be inserted which can be manually activated. This is to allow you to disconnect the inverter from the power supply in an emergency (e.g., when the protective function is activated) so as to prevent a failure or accident from causing the secondary problems.

2.3.6 Wiring for control circuit terminals

WARNING

In general, sheaths and covers of the control signal cables and wires are not specifically designed to withstand a high electric field (i.e., reinforced insulation is not applied). Therefore, if a control signal cable or wire comes into direct contact with a live conductor of the main circuit, the insulation of the sheath or the cover might break down, which would expose the signal wire to a high voltage of the main circuit. Make sure that the control signal cables and wires will not come into contact with live conductors of the main circuit.

Failure to observe these precautions could cause electric shock and/or an accident.

CAUTION

Noise may be emitted from the inverter, motor and wires.

Implement appropriate measure to prevent the nearby sensors and devices from malfunctioning due to such noise.

An accident could occur.

Table 2.7 lists the symbols, names and functions of the control circuit terminals. The wiring to the control circuit terminals differs depending upon the setting of the function codes, which reflects the use of the inverter.

Put back the main circuit terminal block cover and then connect wires to the control circuit terminals. Route these wires correctly to reduce the influence of noise.

Table 2.7 Symbols, Names and Functions of the Control Circuit Terminals

Classification	Symbol	Name	Functions
Analog input	[13]	Power supply for potentiometer	Power supply (+10 VDC) for an external frequency command potentiometer (Potentiometer: 1 to 5 k Ω) A potentiometer of 1/2 W rating or more should be connected Allowable maximum output current: 10mA.
	[12]	Analog setting voltage input	(1) The frequency is commanded according to the external analog input voltage. 0 to +10 (VDC)/0 to 100 (%) (Normal operation) +10 to 0 (VDC)/0 to 100 (%) (Inverse operation) (2) Used for reference signal (PID process command) or PID feedback signal. (3) Used as additional auxiliary setting for various main frequency commands. * Input impedance: 22 k Ω * The allowable maximum input is +15 VDC; however, the voltage higher than +10 VDC is treated as +10 VDC.
	[C1]	Current input	(1) The frequency is commanded according to the external analog input current. +4 to +20 mA DC/0 to 100% (Normal operation) +20 to +4 mA DC/0 to 100% (Inverse operation) +0 to +20 mA DC/0 to 100% (Normal operation) +20 to 0 mA DC/0 to 100% (Inverse operation) (2) Used for reference signal (PID process command) or PID feedback signal. (3) Connects PTC (Positive Temperature Coefficient) thermistor for motor protection. (4) Used as additional auxiliary setting for various main frequency commands. * Input impedance: 250 Ω * The allowable maximum input is +30 mA DC; however, the current larger than +20 mA DC is treated as +20 mA DC. <div style="display: flex; justify-content: space-around; margin-top: 10px;">   </div>
	[11]	Analog common	Common terminal for analog input and output signals This terminal is electrically isolated from terminals [Y1E].

Table 2.7 Symbols, Names and Functions of the Control Circuit Terminals (Continued)

Classification	Symbol	Name	Functions
Analog input			<ul style="list-style-type: none"> - These low level analog signals are especially susceptible to the external noise effects. Route the wiring as short as possible (within 20 m) and use shielded wires. In principle, ground the shielded sheath of wires; if effects of external inductive noises are considerable, connection to terminal [11] may be effective. As shown in Figure 2.5, ground the single end of the shield to enhance the shield effect. - Use a twin-contact relay for low level signals if the relay is used in the control circuit. Do not connect the relay's contact to terminal [11]. - When the inverter is connected to an external device outputting analog signals, the external device may malfunction due to electric noise generated by the inverter. If this happens, according to the circumstances, connect a ferrite core (a toroidal core or equivalent) to the device outputting analog signals or connect a capacitor having the good cut-off characteristics for high frequency between control signal wires as shown in Figure 2.6. - Do not apply a voltage of +7.5 VDC or higher to terminal [C1]. Doing so could damage the internal control circuit.
		<p>Potentiometer 1 k to 5 kΩ</p>	<p>External device (Outputting analog signal)</p> <p>Capacitor 0.022 μF, 50V</p> <p>Ferrite core (Pass the same-phase wires through or turn them around the ferrite core 2 or 3 times.)</p>
		<p>Figure 2.5 Connection of Shielded Wire</p>	<p>Figure 2.6 Example of Electric Noise Reduction</p>

Table 2.7 Symbols, Names and Functions of the Control Circuit Terminals (Continued)

Classification	Symbol	Name	Functions																							
Digital input	[X1]	Digital input 1	<p>(1) The various signals such as "Coast to a stop," "Enable external alarm trip," and "Select multistep frequency" can be assigned to terminals [X1] to [X3], [FWD] and [REV] by setting function codes E01 to E03, E98, and E99. For details, refer to Chapter 5, Section 5.2 "Details of Function Codes."</p> <p>(2) Input mode, i.e. Sink/Source, is changeable by using the internal jumper switch.</p> <p>(3) Switches the logic value (1/0) for ON/OFF of the terminals between [X1] to [X3], [FWD] or [REV], and [CM]. If the logic value for ON between [X1] and [CM] is 1 in the normal logic system, for example, OFF is 1 in the negative logic system and vice versa.</p> <p>(4) The negative logic signaling cannot be applicable to [FWD] and [REV].</p> <p>Digital input circuit specifications</p> <table border="1"> <thead> <tr> <th>Item</th> <th>Min.</th> <th>Max.</th> </tr> </thead> <tbody> <tr> <td rowspan="2">Operation voltage (SINK)</td> <td>ON level</td> <td>0 V</td> <td>2 V</td> </tr> <tr> <td>OFF level</td> <td>22 V</td> <td>27 V</td> </tr> <tr> <td rowspan="2">Operation voltage (SOURCE)</td> <td>ON level</td> <td>22 V</td> <td>27 V</td> </tr> <tr> <td>OFF level</td> <td>0 V</td> <td>2 V</td> </tr> <tr> <td>Operation current at ON (Input Voltage at 0 V)</td> <td>2.5 mA</td> <td>5 mA</td> </tr> <tr> <td>Allowable leakage current at OFF</td> <td>-</td> <td>0.5 mA</td> </tr> </tbody> </table>	Item	Min.	Max.	Operation voltage (SINK)	ON level	0 V	2 V	OFF level	22 V	27 V	Operation voltage (SOURCE)	ON level	22 V	27 V	OFF level	0 V	2 V	Operation current at ON (Input Voltage at 0 V)	2.5 mA	5 mA	Allowable leakage current at OFF	-	0.5 mA
	Item	Min.		Max.																						
	Operation voltage (SINK)	ON level		0 V	2 V																					
		OFF level		22 V	27 V																					
	Operation voltage (SOURCE)	ON level		22 V	27 V																					
OFF level		0 V	2 V																							
Operation current at ON (Input Voltage at 0 V)	2.5 mA	5 mA																								
Allowable leakage current at OFF	-	0.5 mA																								
[X2]	Digital input 2																									
[X3]	Digital input 3																									
[FWD]	Run forward command																									
[REV]	Run reverse command																									
[PLC]	PLC signal power	Connects to PLC output signal power supply. Rated voltage: +24 VDC (Allowable range: +22 to +29 VDC), Max. 50 mA																								
[CM]	Digital common	Common terminal for digital input signals This terminal is electrically isolated from terminals [Y1E].																								

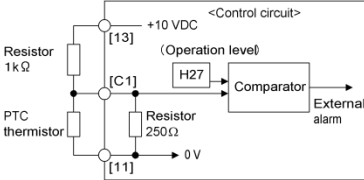
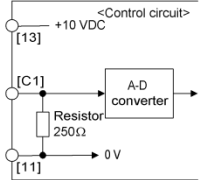
Table 2.7 Symbols, Names and Functions of the Control Circuit Terminals (Continued)

Classification	Symbol	Name	Functions
Digital Input	<p>Tip</p>	<p>Using a relay contact to turn [X1], [X2], [X3], [FWD] or [REV] ON or OFF</p>	<p>Figure 2.7 shows two examples of a circuit that uses a relay contact to turn control signal input [X1], [X2], [X3], [FWD] or [REV] ON or OFF. Circuit (a) has a connecting jumper applied to SINK, whereas circuit (b) has one that is applied to SOURCE.</p> <p>Note: To configure this kind of circuit, use a highly reliable relay. (Recommended product: Fuji control relay Model HH54PW)</p>  <p>(a) With a jumper applied to SINK</p> <p>(b) With a jumper applied to SOURCE</p>
	<p>Using a programmable logic controller (PLC) to turn [X1], [X2], [X3], [FWD] or [REV] ON or OFF</p>	<p>Figure 2.8 shows example of a circuit that uses a programmable logic controller (PLC) to turn control signal input [X1], [X2], [X3], [FWD] or [REV] ON or OFF. Circuit (a) has a connecting jumper applied to SOURCE.</p> <p>In circuit (a) below, short-circuiting or opening the transistor's circuit in the PLC using an external power source turns control signal [X1], [X2], [X3], [FWD] or [REV] ON or OFF.</p>  <p>(a) With a jumper applied to SOURCE</p>	<p>Figure 2.7 Circuit Configuration Using a Relay Contact</p> <p>Figure 2.8 Circuit Configuration Using a PLC</p> <p>For details about the jumper setting, refer to Section 2.3.7 "Setting up the jumper switches."</p>

Table 2.7 Symbols, Names and Functions of the Control Circuit Terminals (Continued)

Classification	Symbol	Name	Functions
Analog output	[FMA]	Analog monitor	<p>The monitor signal for analog DC voltage (0 to +10 VDC) is output. The signal functions can be selected from the following with function code F31.</p> <ul style="list-style-type: none"> - Output frequency (before slip compensation) - Output frequency (after slip compensation) - Output current - Input power - DC link bus voltage - PID command (SV) - Output voltage - PID feedback amount - Calibration - PID output (MV) <p>*Input impedance of external device: Min. 5 kΩ</p>
	[11]	Analog common	<p>Common terminal for analog input and output signals</p> <p>This terminal is electrically isolated from terminals [Y1E].</p>
Transistor output	[Y1]	Transistor output	<p>(1) Various signals such as "Inverter running," "Frequency arrival signal" and "Motor overload early warning" can be assigned to terminal [Y1] by setting function code E20. Refer to Chapter 5, Section 5.2 "Details of Function Codes."</p> <p>(2) Switches the logic value (1/0) for ON/OFF of the terminals between [Y1] and [Y1E]. If the logic value for ON between [Y1] and [Y1E] is 1 in the normal logic system, for example, OFF is 1 in the negative logic system and vice versa.</p> <p><u>Digital input circuit specification</u></p>  <p>Figure 2.9 shows examples of connection between the control circuit and a PLC.</p> <p>Note</p> <ul style="list-style-type: none"> - Check the polarity of the external power inputs. - When connecting a control relay, first connect a surge-absorbing diode across the coil of the relay.
	[PLC]	Transistor output power	<p>Power source of +24 VDC to be fed to the transistor output circuit load (50 mA at maximum).</p> <p>To enable the source, it is necessary to short-circuit between terminals [Y1E] and [CM].</p> <p>Can also be used as a 24 VDC power source.</p>
	[Y1E]	Transistor output common	<p>Common terminal for transistor output signal</p> <p>This terminal is electrically isolated from terminals [CM] and [11].</p>

Note

- Route the wiring of the control terminals as far from the wiring of the main circuit as possible. Otherwise electric noise may cause malfunctions.
- Fix the control circuit wires inside the inverter to keep them away from the live parts of the main circuit (such as the terminal block of the main circuit).

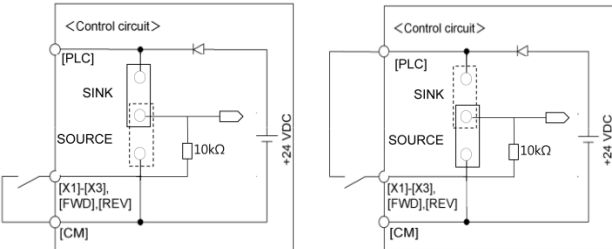
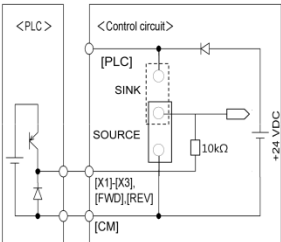
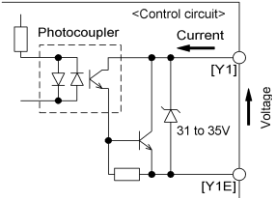
2.3.7 Setting up the jumper switches

WARNING

Before changing the jumper switches, turn OFF the power and wait at least five minutes. Make sure that the LED monitor is turned OFF.

An electric shock may result if this warning is not heeded as there may be some residual electric charge in the DC link bus capacitor even after the power has been turned OFF.

Switching the jumper switches (shown in Figure 2.11) allows you to customize the specifications of the digital I/O terminals and the RS-485 communication terminating resistor.

To access the jumper switches, remove the terminal block covers.

For details on how to remove the terminal block covers, refer to Section 2.3.1.

Table 2.8 lists function of each jumper switch.

Table 2.8 Function of Jumper Switches

Switch	Function
① SW10	<u>SINK/SOURCE switch for digital input terminals</u> <ul style="list-style-type: none">• To use digital input terminals [X1] to [X3], [FWD] and [REV] in the SINK mode, set a jumper in the sink position, to use them in the SOURCE mode, set a jumper in the source position. (See Figure 2.11.)• To switch between SINK and SOURCE modes, use a mini needle-nose pliers or the similar tool to change the mounting position of the jumper.
② SW9	<u>Terminating resistor ON/OFF switch for RS-485 communication</u> <ul style="list-style-type: none">• To connect an optional remote keypad, set a jumper in the OFF position (factory default).• If the inverter is connected to the RS-485 communications network as a terminating device, set a jumper in the ON position.• To switch the terminating resistor ON and OFF, use a mini needle-nose pliers or the similar tool to change the mounting position of the jumper.

Figure 2.11 shows the locations of jumper switches and the RJ-45 connector.

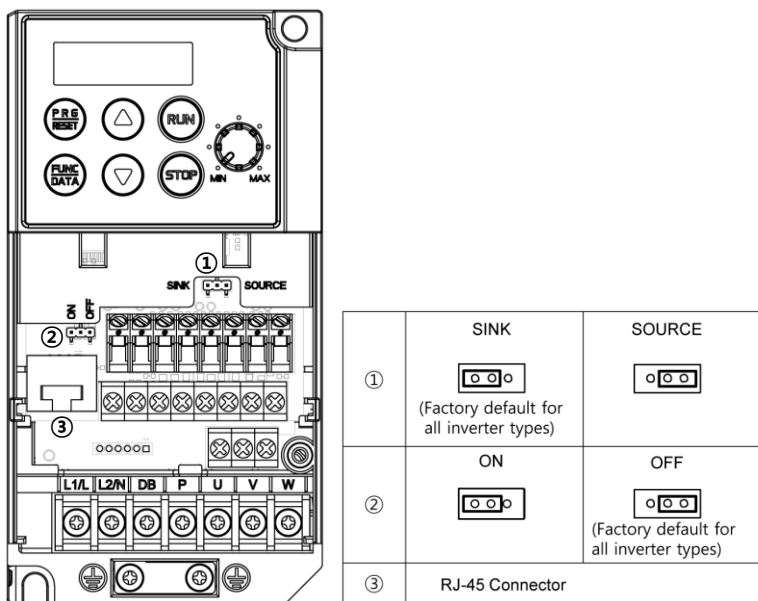

Figure 2.11 Locations of Jumper Switches and RJ-45 Connector

Chapter 3 OPERATION USING THE KEYPAD

3.1 Names and Functions of Keypad Components

As shown in the figure at right, the keypad consists of a four-digit 7-segment LED monitor, a potentiometer (POT), and six keys.

The keypad allows you to start and stop the motor, monitor running status, configure the function code data, check I/O signal states, and display maintenance information and alarm information.

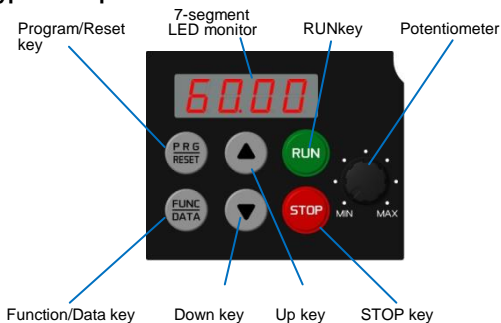

Table 3.1 Names and Functions of Keypad Components

Monitor, Potentiometer and Keys	Functions
	Four-digit, 7-segment LED monitor which displays the following according to the operation modes *. In Running mode: Running status information (e.g., output frequency, current, and voltage) In Programming mode: Menus, function codes and their data In Alarm mode: Alarm code which identifies the error factor if the protective function is activated.
	Potentiometer (POT) which is used to manually set a reference frequency, auxiliary frequencies 1 and 2 or PID process command.
	RUN key. Press this key to run the motor.
	STOP key. Press this key to stop the motor.
	UP/DOWN keys. Press these keys to select the setting items and change the function code data displayed on the LED monitor.
	Program/Reset key which switches the operation modes* of the inverter. In Running mode: Pressing this key switches the inverter to Programming mode. In Programming mode: Pressing this key switches the inverter to Running mode. In Alarm mode: Pressing this key after removing the error factor switches the inverter to Running mode.
	Function/Data key which switches the operation you want to do in each mode as follows: In Running mode: Pressing this key switches the information to be displayed concerning the status of the inverter (output frequency, output current, output voltage, etc.). In Programming mode: Pressing this key displays the function codes and sets their data entered with the ▲ and ▼ keys or the POT. In Alarm mode: Pressing this key displays detailed alarm information.

* iMaster-U1 features three operation modes: Running, Programming, and Alarm. Refer to Section 3.2 "Overview of Operation Modes."

Simultaneous keying

Simultaneous keying means pressing two keys at the same time (expressed by "+"). iMaster-U1 supports simultaneous keying as listed below.









(For example, the expression "STOP +  keys" stands for pressing the  key while holding down the  key.)

Table 3.2 Simultaneous Keying

Operation mode	Simultaneous keying	Used to:
Running mode	 +  keys	Control entry to/exit from jogging operation.
Programming mode	 +  keys	Change certain function code data. (Refer to function codes F00, H03, H45 and H97 in Chapter 5 "FUNCTION CODES.")
Alarm mode	 +  keys	Switch to Programming mode without clearing alarms.

About changing of function code data

The function code data can be changed only when the data value displayed on the LED monitor is flashing.

When the data value is lit, no change is allowed. To change the data, stop the inverter or disable the data protection.

3.2 Overview of Operation Modes

iMaster-U1 features the following three operation modes:

Running mode : This mode allows you to enter run/stop commands in regular operation. You can also monitor the running status in real time.

Programming mode : This mode allows you to configure function code data and check a variety of information relating to the inverter status and maintenance.

Alarm mode : If an alarm occurs, the inverter automatically enters the Alarm mode. In this mode, you can view the corresponding alarm code* and its related information on the LED monitor.

* Alarm code: Indicates the cause of the alarm condition that has triggered the protective function. For details, refer to Chapter 8, Section 8.3 "Protective Functions."

Figure 3.1 shows the status transition of the inverter between these three operation modes.

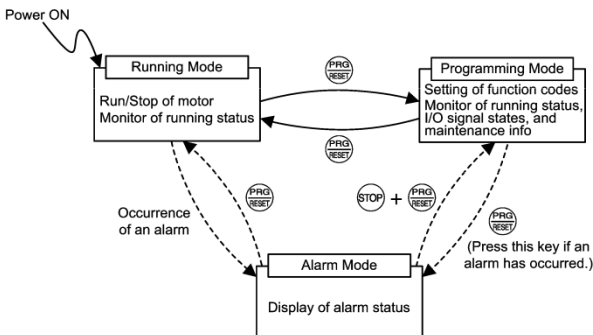

Figure 3.1 Status Transition between Operation Modes

Chapter 4 RUNNING THE MOTOR

4.1 Test Run

4.1.1 Checking prior to powering on

Check the following prior to powering on the inverter.

- (1) Check the wiring to the power input terminals (L1/R, L2/S and L3/T or L1/L and L2/N) and inverter output terminals (U, V and W). Also check that the grounding wires are connected to the grounding terminals correctly. See Figure 4.1.

⚠ WARNING ⚠
<ul style="list-style-type: none">• Do not connect power supply wires to the inverter output terminals U, V, and W. Otherwise, the inverter may be broken if you turn the power ON.• Be sure to connect the grounding wires of the inverter and the motor to the ground electrodes. <p>Otherwise, electric shock may occur.</p>

- (2) Check the control circuit terminals and main circuit terminals for short circuits or ground faults.
- (3) Check for loose terminals, connectors and screws.
- (4) Check that the motor is separated from mechanical equipment.
- (5) Make sure that all switches of devices connected to the inverter are turned OFF. (Powering on the inverter with any of those switches being ON may cause an unexpected motor operation.)
- (6) Check that safety measures are taken against runaway of the equipment, e.g., a defense to prevent people from access to the equipment.

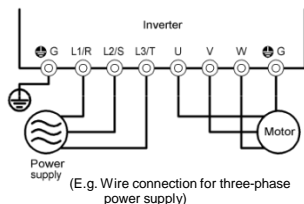

Figure 4.1 Connection of Main Circuit Terminals

4.1.2 Powering ON and checking

⚠ WARNING ⚠
<ul style="list-style-type: none">• Be sure to mount the terminal block covers before turning the power ON. Do not remove any cover while powering on.• Do not operate switches with wet hands. <p>Otherwise electric shock could occur.</p>

Turn the power ON and check the following points. This is a case when no function code data is changed from the factory defaults.

- (1) Check that the LED monitor displays *00 (indicating at the frequency command is 0 Hz) that is blinking. (See Figure 4.2.)

If the LED monitor displays any number except *00, use the potentiometer to set *00.

- (2) Check that the built-in cooling fan rotates.



Figure 4.2 Display of the LED Monitor

4.1.3 Preparation before a test run--Configuring function code data

Before running the motor, configure function code data specified in Table 4.1 in accordance with the motor ratings and your system design values. The motor ratings are printed on the nameplate of the motor. For your system design values, ask system designers about them.

- For details about how to change function code data, refer to Chapter 3, Section 3.4.1 "Setting the function codes – "Data Setting." Refer to the function code H03 in Chapter 5 "FUNCTION CODES" for the factory defaults of motor parameters. If any of them is different from the default setting, change the function code data.

Table 4.1 Settings of Function Code Data before a Test Run

Function code	Name	Function code data	Factory setting
F04	Base frequency	Motor ratings (printed on the nameplate of the motor)	60.0 (Hz)
F05	Rated voltage at base frequency		0 (V)
			0 (V)
P02	Motor parameter (Rated capacity)		Applicable motor rated capacity
P03	Motor parameter (Rated current)		Rated current of applicable motor
P99	Motor selection	0: Motor characteristics	
F03	Maximum frequency	System design values * For a test-driving of the motor, increase values so that they are longer than your system design values. If the set time is short, the inverter may not start running the motor.	60.0 (Hz)
F07	Acceleration time1*		6.00 (s)
F08	Deceleration time1*		6.00 (s)

4.1.4 Test run

WARNING

If the user configures the function codes wrongly without completely understanding this Instruction Manual, the motor may rotate with a torque or at a speed not permitted for the machine.





Accident or injury may result.

Follow the descriptions given in Section 4.1.1 "Checking prior to powering on" to Section 4.1.3 "Preparation before a test," then begin the test run of the motor.

CAUTION



If any abnormality is found in the inverter or motor, immediately stop operation and investigate the cause referring to Chapter 6 "TROUBLESHOOTING."

----- Test Run Procedure -----

- (1) Turn the power ON and check that the reference frequency *00 Hz is blinking on the LED monitor.
- (2) Set a low reference frequency such as 5 Hz, using  /  keys. (Check that the frequency is blinking on the LED monitor.)
- (3) Press the  key to start running the motor in the forward direction. (Check that the reference frequency is displayed on the LED monitor.)
- (4) To stop the motor, press the  key.

< Check points during a test run >

- Check that the motor is running in the forward direction.
- Check for smooth rotation without motor humming or excessive vibration.
- Check for smooth acceleration and deceleration.

When no abnormality is found, press the  key again to start driving the motor, then increase the reference frequency using  /  keys. Check the above points again.

If any problem is found, modify the function code data again as described below.

4.2 Operation

After confirming that the inverter normally drives the motor in a test run, make mechanical connections (connections to the machine system) and electrical connections (wiring and cabling), and configure the necessary function codes properly before starting a production run.

 **Note** Depending on the production run conditions, further adjustments may be required, such as adjustments of torque boost (F09), acceleration time (F07, E10), and deceleration time (F08, E11).







Chapter 5 FUNCTION CODES

5.1 Function Code Tables

Function codes enable the iMaster-U1 of inverters to be set up to match your system requirements. Each function code consists of a 3-letter alphanumeric string. The first letter is an alphabet that identifies its group and the following two letters are numerals that identify each individual code in the group. The function codes are classified into seven groups: Fundamental Functions (F codes), Extension Terminal Functions (E codes), Control Functions (C codes), Motor 1 Parameters (P codes), High Performance Functions (H codes), Application Functions (J codes) and Link Functions (y codes). To determine the property of each function code, set data to the function code.

Changing, validating, and saving function code data when the motor is running

Function codes are indicated by the following based on whether they can be changed or not when the inverter is running:

Notation	Change when running	Validating and saving function code data
Y*	Possible	If the data of the codes marked with Y* is changed, the change will immediately take effect; however, the change is not saved into the inverter's memory. To save the change, press the  key. If you press the  key without pressing the  key to exit the current state, then the changed data will be discarded and the previous data will take effect for the inverter operation.
Y	Possible	The data of the codes marked with Y can be changed with the  and  keys regardless of whether the motor is running or not. Pressing the  key will make the change effective and save it into the inverter's memory.
N	Impossible	—

Using negative logic for programmable I/O terminals

The negative logic signaling system can be used for digital input terminals and transistor output terminals by setting the function code data specifying the properties for those terminals. Negative logic refers to the inverted ON/OFF (logical value 1 (true)/0 (false)) state of input or output signal. An active-ON signal (the function takes effect if the terminal is short-circuited.) in the normal logic system is functionally equivalent to active-OFF signal (the function takes effect if the terminal is opened.) in the negative logic system. An active-ON signal can be switched to active-OFF signal, and vice versa, with the function code data setting.

To set the negative logic system for an input or output terminal, enter data of 1000s (by adding 1000 to the data for the normal logic) in the corresponding function code.

Example: "Coast to a stop" command **BX** assigned to any of digital input terminals [X1] to [X3] using any of function codes E01 through E03.

Function code data	BX
7	Turning BX ON causes the motor to coast to a stop. (Active ON)
1007	Turning BX OFF causes the motor to coast to a stop. (Active OFF)

Limitation of data displayed on the LED monitor

Only four digits can be displayed on the 4-digit LED monitor. If you enter more than 4 digits of data valid for a function code, any digits after the 4th digit of the set data will not be displayed; however they will be processed correctly.

The following tables list the function codes available for the iMaster-U1 of inverters.

F codes: Fundamental Functions

Code	Name	Data setting range	Increment	Unit	Change when running	Data copying	Default setting
F00	Data Protection	0: Disable both data protection and digital reference protection 1: Enable data protection and disable digital reference protection 2: Disable data protection and enable digital reference protection 3: Enable both data protection and digital reference protection	—	—	Y	Y	0
F01	Frequency Command 1	0: UP/DOWN keys on keypad 1: Voltage input to terminal [12] (0 to +10 VDC) 2: Current input to terminal [C1] (4 to 20 mA DC) 3: Sum of voltage and current inputs to terminals [12] and [C1] 4: Built-in potentiometer (POT) 7: Terminal command UP/DOWN control	—	—	N	Y	4

Code	Name	Data setting range	Increment	Unit	Change when running	Data copying	Default setting
F02	Operation Method	0: RUN/STOP keys on keypad (Motor rotational direction specified by terminal command FWD/REV) 1: Terminal command FWD or REV 2: RUN/STOP keys on keypad (forward) 3: RUN/STOP keys on keypad (reverse)	-	-	N	Y	2
F03	Maximum Frequency 1	25.0 to 400.0	0.1	Hz	N	Y	60.0
F04	Base Frequency 1	25.0 to 400.0	0.1	Hz	N	Y	60.0
F05	Rated Voltage at Base Frequency 1	0: Output a voltage in proportion to input voltage 80 to 240: Output an AVR-controlled voltage (for 200 V class series) 160 to 500: Output an AVR-controlled voltage (for 400 V class series)	1	V	N	Y2	0
F06	Maximum Output Voltage 1	80 to 240: Output an AVR-controlled voltage (for 200 V class series) 160 to 500: Output an AVR-controlled voltage (for 400 V class series)	1	V	N	Y2	200 (400)
F07	Acceleration Time 1	0.00 to 3600 Note: Entering 0.00 cancels the acceleration time, requiring external soft-start.	0.01	s	Y	Y	6.00
F08	Deceleration Time 1	0.00 to 3600 Note: Entering 0.00 cancels the deceleration time, requiring external soft-start.	0.01	s	Y	Y	6.00
F09	Torque Boost 1	0.0 to 20.0 (percentage with respect to "F05: Rated Voltage at Base Frequency 1") Note: This setting takes effect when F37 = 0, 1.	0.1	%	Y	Y	See Table A.
F10	Electronic Thermal Overload Protection for Motor 1 (Motor characteristics) (Overload detection level)	1: For a general-purpose motor with shaft-driven cooling fan 2: For an inverter-driven motor with separately powered cooling fan	-	-	Y	Y	1
F11	(Thermal time constant)	0.00: Disable, 0.01 to 100.0 1 to 135% of the rated current (allowable continuous drive current) of the motor	0.01	A	Y	Y1 Y2	See Table A.
F12		0.5 to 75.0	0.1	min	Y	Y	5.0
F14	Restart Mode after Momentary Power Failure (Mode selection)	0: Disable restart (Trip immediately) 1: Disable restart (Trip after a recovery from power failure) 2: Trip after decelerate-to-stop *2 4: Enable restart (Restart at the frequency at which the power failure occurred, for general loads) 5: Enable restart (Restart at the starting frequency)	-	-	Y	Y	1
F15	Frequency Limiter (High) (Lo)	0.0 to 400.0	0.1	Hz	Y	Y	70.0
F16		0.0 to 400.0	0.1	Hz	Y	Y	0.0

(F codes continued)

Code	Name	Data setting range	Increment	Unit	Change when running	Data copying	Default setting
F18	Bias (Frequency command 1)	-100.00 to 100.00 *1	0.01	%	Y*	Y	0.00
F20	DC Braking 1 (Braking starting frequency)	0.0 to 60.0	0.1	Hz	Y	Y	0.0
F21	(Braking level)	0 to 100 *2	1	%	Y	Y	0
F22	(Braking time)	0.00 (Disable), 0.01 to 30.00	0.01	s	Y	Y	0.00
F23	Starting Frequency 1	0.1 to 60.0	0.1	Hz	Y	Y	1.0
F24	(Holding time)	0.00 to 10.00	0.01	s	Y	Y	0.00
F25	Stop Frequency	0.1 to 60.0	0.1	Hz	Y	Y	0.2
F26	Motor Sound (Carrier frequency)	0.75 to 16	1	kHz	Y	Y	2
F27	(Tone)	0: Level 0 (Inactive) 1: Level 1	-	-	Y	Y	0
F30	Analog Output [FMA] (Voltage adjustment)	0 to 300	1	%	Y*	Y	100
F31	(Function)	Select a function to be monitored from the followings. 0: Output frequency 1 (before slip compensation) 1: Output frequency 2 (after slip compensation) 2: Output current 3: Output voltage 7: PID feedback amount (PV) 9: DC link bus voltage 14: Calibration 15: PID command (SV) 16: PID output (MV)	-	-	Y	Y	0
F37	Load Selection/Auto Torque Boost	0: Variable torque load 1: Constant torque load 2: Auto-torque boost	-	-	N	Y	1
F39	Stop Frequency (Holding Time)	0.00 to 10.00	0.01	s	Y	Y	0.00
F42	Control Mode Selection 1	0: V/f control with slip compensation inactive 1: Dynamic torque vector control 2: V/f control with slip compensation active	-	-	N	Y	0

(F codes continued)

Code	Name	Data setting range	Increment	Unit	Change when running	Data copying	Default setting
F43	Current Limiter (Mode selection)	0: Disable (No current limiter works.) 1: Enable at constant speed (Disable during ACC/DEC) 2: Enable during ACC/constant speed operation	-	-	Y	Y	2
F44	(Level)	20 to 180 (The data is interpreted as the rated output current of the inverter for 100%.) *2	1	%	Y	Y	180
F50	Electronic Thermal Overload Protection for Braking Resistor (Discharging capability)	1 to 900, OFF (Cancel)	1	kWs	Y	Y1 Y2	OFF
F51	(Allowable average loss)	0.001 to 50.00	0.001	kW	Y	Y1 Y2	0.001

*1 When you make settings from the keypad, the incremental unit is restricted by the number of digits that the LED monitor can display.

(Example) If the setting range is from -200.00 to 200.00, the incremental unit is:

"1" for -200 to -100, "0.1" for -99.9 to -10.0 and for 100.0 to 200.0, and "0.01" for -9.99 to -0.01 and for 0.00 to 99.99.

*2 The percentage is relative to the rated output current.

E codes: Extension Terminal Functions

Code	Name	Data setting range	Increment	Unit	Change when running	Data copying	Default setting
E01	Terminal [X1] Function	Selecting function code data assigns the corresponding function to terminals [X1] to [X3] as listed below.	-	-	N	Y	0
E02	Terminal [X2] Function	0 (1000): Select multistep frequency (SS1)	-	-	N	Y	7
E03	Terminal [X3] Function	1 (1001): Select multistep frequency (SS2) 2 (1002): Select multistep frequency (SS4) 3 (1003): Select multistep frequency (SS8) 4 (1004): Select ACC/DEC time (RT1) 6 (1006): Enable 3-wire operation (HLD) 7 (1007): Coast to a stop (BX) 8 (1008): Reset alarm (RST) 9 (1009): Enable external alarm trip (THR) 10 (1010): Ready for jogging (JOG) 11 (1011): Select frequency command 2/1 (Hz2/Hz1) 13: Enable DC braking (DCBRK) 17 (1017): UP (Increase output frequency) (UP) 18 (1018): DOWN (Decrease output frequency) (DOWN) 19 (1019): Enable data change with keypad (WE-KP) 20 (1020): Cancel PID control (Hz/PID) 21 (1021): Switch normal/inverse operation (IVS) 24 (1024): Enable communications link via RS-485 (LE) 33 (1033): Reset PID integral and differential components (PID-RST) 34 (1034): Hold PID integral component (PID-HLD) 90(1090) : Traverse On (TRV) 91(1091) : Traverse Up Offset (TRV UP_OFFSET) 92(1092) : Traverse Dn Offset (TRV DN_OFFSET) Setting the value in parentheses () shown above assigns a negative logic input (Active-OFF) to a terminal. Note that, in the case of THR , data "1009" is for normal logic (Active-ON) and "9," for negative logic (Active-OFF). Signals having no value in parentheses () cannot be used for negative logic.	-	-	N	Y	8
E10	Acceleration Time 2	0.00 to 3600 Note: Entering 0.00 cancels the acceleration time, requiring external soft-start and -stop.	0.01	s	Y	Y	6.00
E11	Deceleration Time 2	0.00 to 3600 Note: Entering 0.00 cancels the deceleration time, requiring external soft-start and -stop.	0.01	s	Y	Y	6.00

(E codes continued)

Code	Name	Data setting range	Increment	Unit	Change when running	Data copying	Default setting
E20	Terminal [Y1] Function	Selecting function code data assigns the corresponding function to terminals [Y1] and [30A/B/C] as listed below.	-	-	N	Y	0
E27	Terminal [30A/B/C] Function	0 (1000): Inverter running (<i>RUN</i>) 1 (1001): Frequency arrival signal (<i>FAR</i>) 2 (1002): Frequency detected (<i>FDT</i>) 3 (1003): Undervoltage detected (Inverter stopped) (<i>LU</i>) 5 (1005): Inverter output limiting (<i>IOL</i>) 6 (1006): Auto-restarting after momentary power failure (<i>IPF</i>) 7 (1007): Motor overload early warning (<i>OL</i>) 26 (1026): Auto-resetting (<i>TRY</i>) 30 (1030): Service lifetime alarm (<i>LIFE</i>) 35 (1035): Inverter running 2 (<i>RUN2</i>) 36 (1036): Overload prevention control (<i>OLP</i>) 37 (1037): Current detected (<i>ID</i>) 38 (1038): Current detected 2 (<i>ID2</i>) 41 (1041): Low current detected (<i>IDL</i>) 43 (1043): Under PID control (<i>PID-CTL</i>) 44 (1044): Motor stopped due to slow flowrate under PID control (<i>PID-STP</i>) 56 (1056): Motor overheat detected by thermistor (<i>THM</i>) 57 (1057): Brake signal (<i>BRKS</i>) 59 (1059): Terminal [C1] wire break (<i>C1OFF</i>) 84 (1084): Maintenance timer (<i>MNT</i>) 87 (1087): Frequency arrival detected (<i>FARFDT</i>) 90(1090): Traverse Up (<i>TRV_UP</i>) 91(1091): Traverse Out (<i>TRV_OUT</i>) 99 (1099): Alarm output (for any alarm) (<i>ALM</i>) Setting the value in parentheses () shown above assigns a negative logic output to a terminal.	-	-	N	Y	99
E30	Frequency Arrival (Hysteresis width)	0.0 to 10.0	0.1	Hz	Y	Y	2.5
E31	Frequency Detection (Detection level)	0.0 to 400.0	0.1	Hz	Y	Y	60.0
E32	(Hysteresis width)	0.0 to 400.0	0.1	Hz	Y	Y	1.0
E34	Overload Early Warning/ Current Detection/Low Current Detection (Level)	0.00 (Disable), 0.01 to 100.0 Current value of 1 to 200% of the inverter rated current	0.01	A	Y	Y1 Y2	See Table A.
E35	(Timer)	0.01 to 600.00 *1	0.01	s	Y	Y	10.00

*1 When you make settings from the keypad, the incremental unit is restricted by the number of digits that the LED monitor can display.

(Example) If the setting range is from -200.00 to 200.00, the incremental unit is:

"1" for -200 to -100, "0.1" for -99.9 to -10.0 and for 100.0 to 200.0, and "0.01" for -9.99 to -0.01 and for 0.00 to 99.99.

(E codes continued)

Code	Name	Data setting range	Increment	Unit	Change when running	Data copying	Default setting
E37	Current Detection 2 (Level)	0.00 (Disable), 0.01 to 100.0 Current value of 1 to 200% of the inverter rated current	0.01	A	Y	Y1 Y2	See Table A.
E38	(Timer)	0.01 to 600.00 *1	0.01	s	Y	Y	10.00
E39	Coefficient for Constant Feeding Rate Time	0.000 to 9.999	0.001	-	Y	Y	0.000
E40	PID Display Coefficient A	-999 to 0.00 to 9990 *2	0.01	-	Y	Y	100
E41	PID Display Coefficient B	-999 to 0.00 to 9990 *2	0.01	-	Y	Y	0.00
E42	LED Display Filter	0.0 to 5.0	0.1	s	Y	Y	0.5
E43	LED Monitor (Display item)	0: Speed monitor (select by E48) 3: Output current 4: Output voltage 10: PID command 12: PID feedback amount 13: Timer 14: PID output 25: Input watt-hour	-	-	Y	Y	0
E48	LED Monitor (Speed monitor item)	0: Output frequency (Before slip compensation) 1: Output frequency (After slip compensation) 2: Reference frequency 4: Load shaft speed in r/min 5: Line speed in m/min 6: Constant feeding rate time	-	-	Y	Y	0
E50	Coefficient for Speed Indication	0.01 to 200.00 *1	0.01	-	Y	Y	30.00
E52	Keypad (Menu display mode)	0: Function code data editing mode (Menu #1) 1: Function code data check mode (Menu #2) 2: Full-menu mode (Menus #0 through #6)	-	-	Y	Y	0

(Note) E45, E46 and E47 appear on the LED monitor, but cannot be used by this inverter.

*1 When you make settings from the keypad, the incremental unit is restricted by the number of digits that the LED monitor can display.

(Example) If the setting range is from -200.00 to 200.00, the incremental unit is:

"1" for -200 to -100, "0.1" for -99.9 to -10.0 and for 100.0 to 200.0, and "0.01" for -9.99 to -0.01 and for 0.00 to 99.99.

*2 The significant figure is in three digits, so the incremental unit changes depending upon the magnitude of absolute values.

(Example) The incremental unit is "10" for 1000 to 9990, "1" for -999 to -100 and for 100 to 999, "0.1" for -99.9 to -10.0 and for 10.0 to 99.9, and "0.01" for -9.99 to 9.99.

(E codes continued)

Code	Name	Data setting range	Increment	Unit	Change when running	Data copying	Default setting
E60	Built-in Potentiometer (Function selection)	0: None 1: Auxiliary frequency command 1 2: Auxiliary frequency command 2 3: PID process command 1	1	—	N	Y	0
E61	Terminal [12] Extended Function	Selecting function code data assigns the corresponding function to terminals [12] and [C1] as listed below. 0: None	—	—	N	Y	0
E62	Terminal [C1] Extended Function	1: Auxiliary frequency command 1 2: Auxiliary frequency command 2 3: PID process command 1 5: PID feedback value	—	—	N	Y	0
E98	Terminal [FWD] Function	Selecting function code data assigns the corresponding function to terminals [FWD] and [REV] as listed below.	—	—	N	Y	98
E99	Terminal [REV] Function	0 (1000): Select multistep frequency (SS1) 1 (1001): Select multistep frequency (SS2) 2 (1002): Select multistep frequency (SS4) 3 (1003): Select multistep frequency (SS8) 4 (1004): Select ACC/DEC time (RT1) 6 (1006): Enable 3-wire operation (HLD) 7 (1007): Coast to a stop (BX) 8 (1008): Reset alarm (RST) 9 (1009): Enable external alarm trip (THR) 10 (1010): Ready for jogging (JOG) 11 (1011): Select frequency command 2/1 (Hz2/Hz1) 13: Enable DC braking (DCBRK) 17 (1017): UP (Increase output frequency) (UP) 18 (1018): DOWN (Decrease output frequency) (DOWN) 19 (1019): Enable data change with keypad (WE-KP) 20 (1020): Cancel PID control (Hz/PID) 21 (1021): Switch normal/inverse operation (IVS) 24 (1024): Enable communications link via RS-485 (LE) 33 (1033): Reset PID integral and differential components (PID-RST) 34 (1034): Hold PID integral component (PID-HLD) 90(1090): Traverse On (TRV) 91(1091): Traverse Up Offset (TRV_UP_OFFSET) 92(1092): Traverse Dn Offset (TRV_Dn_OFFSET) 98: Run forward (FWD) 99: Run reverse (REV) Setting the value in parentheses () shown above assigns a negative logic input (Active-OFF) to a terminal. Note that, in the case of THR , data "1009" is for normal logic (Active-ON) and "9," for negative logic (Active-OFF). Signals having no value in parentheses () cannot be used for negative logic.	—	—	N	Y	99

C codes: Control Functions

Code	Name	Data setting range	Increment	Unit	Change when running	Data copying	Default setting
C01	Jump Frequency 1 2 3	0.0 to 400.0	0.1	Hz	Y	Y	0.0
C02					Y	Y	0.0
C03					Y	Y	0.0
C04	(Hysteresis width)	0.0 to 30.0	0.1	Hz	Y	Y	3.0
C05	Multistep Frequency 1 2 3 4 5 6 7 8 9 10 11 12 13 14 15	0.00 to 400.00 *1	0.01	Hz	Y	Y	0.00
C06					Y	Y	0.00
C07					Y	Y	0.00
C08					Y	Y	0.00
C09					Y	Y	0.00
C10					Y	Y	0.00
C11					Y	Y	0.00
C12					Y	Y	0.00
C13					Y	Y	0.00
C14					Y	Y	0.00
C15					Y	Y	0.00
C16					Y	Y	0.00
C17					Y	Y	0.00
C18					Y	Y	0.00
C19	Y	Y	0.00				
C20	Jogging Frequency	0.00 to 400.00 *1	0.01	Hz	Y	Y	0.00
C21	Timer Operation	0: Disable 1: Enable	-	-	N	Y	0
C30	Frequency Command 2	0: UP/DOWN keys on keypad 1: Voltage input to terminal [12] (0 to +10 VDC) 2: Current input to terminal [C1] (4 to 20 mA DC) 3: Sum of voltage and current inputs to terminals [12] and [C1] 4: Built-in potentiometer (POT) 7: Terminal command UP/DOWN control	-	-	N	Y	2
C32	Analog Input Adjustment for Terminal [12] (Gain)	0.00 to 200.00 *1	0.01	%	Y*	Y	100.0
C33	(Filter time constant)	0.00 to 5.00	0.01	s	Y	Y	0.05
C34	(Gain base point)	0.00 to 100.00 *1	0.01	%	Y*	Y	100.00
C37	Analog Input Adjustment for Terminal [C1] (Gain)	0.00 to 200.00 *1	0.01	%	Y*	Y	100.00
C38	(Filter time constant)	0.00 to 5.00	0.01	s	Y	Y	0.05
C39	(Gain base point)	0.00 to 100.00 *1	0.01	%	Y*	Y	100.00
C40	Terminal [C1] Input Range Selection	0: 4 to 20 mA 1: 0 to 20 mA	-	-	N	Y	0
C50	Bias (Frequency command 1) (Bias base point)	0.00 to 100.00 *1	0.01	%	Y*	Y	0.00
C51	Bias (PID command 1) (Bias value)	-100.00 to 100.00 *1	0.01	%	Y*	Y	0.00
C52	(Bias base point)	0.00 to 100.00 *1	0.01	%	Y*	Y	0.00

*1 When you make settings from the keypad, the incremental unit is restricted by the number of digits that the LED monitor can display. (Example) If the setting range is from -200.00 to 200.00, the incremental unit is:

"1" for -200 to -100, "0.1" for -99.9 to -10.0 and for 100.0 to 200.0, and "0.01" for -9.99 to -0.01 and for 0.00 to 99.99.

(C codes continued)

Code	Name	Data setting range	Increment	Unit	Change when running	Data copying	Default setting
C99	Digital Reference Frequency	0.00 to 400.00	0.01	Hz	-	Y	0.00

P codes: Motor 1 Parameters

Code	Name	Data setting range	Increment	Unit	Change when running	Data copying	Default setting
P02	Motor 1(Rated capacity (Rated current)	0.01 to 30.00 0.01 to 30.00	0.01 0.01	kW HP	N	Y1 Y2	See Table A
P03	(Auto-tuning)	0.00 to 100.0	0.01	A	N	Y1 Y2	
P04	(No-load current) (%R1) (%X)	0: Disable 1: Tune when the motor stops (%R1, %X)	-	-	N	N	0
P06	(Slip compensation gain for driving)	0.00 to 50.00	0.01	A	N	Y1 Y2	
P07	(Slip compensation response time)	0.00 to 50.00	0.01	%	Y	Y1 Y2	
P08	(Slip compensation gain for braking)	0.00 to 50.00	0.01	%	Y	Y1 Y2	
P09	(Rated slip frequency)	0.0 to 200.0	0.1	%	Y*	Y	100.0
P10		0.01 to 10.00	0.01	s	Y	Y1 Y2	1.00
P11		0.0 to 200.0	0.1	%	Y*	Y	100.0
P12		0.00 to 15.00	0.01	Hz	N	Y1 Y2	
P99	Motor 1 Selection	0: Motor characteristic	-	-	N	Y1 Y2	0

H codes: High Performance Functions

Code	Name	Data setting range	Increment	Unit	Change when running	Data copying	Default setting
H03	Data Initialization	0: Disable initialization 1: Initialize all function code data to the factory defaults 2: Initialize motor 1 parameters	-	-	N	N	0
H04	Auto-reset (Times)	0 (Disable), 1 to 10	1	times	Y	Y	0
H05	(Reset interval)	0.5 to 20.0	0.1	s	Y	Y	5.0
H06	Cooling Fan ON/OFF Control	0: Disable (Cooling fan always ON) 1: Enable (ON/OFF control effective)	-	-	Y	Y	0
H07	Acceleration/Deceleration Pattern	0: Linear 1: S-curve (Weak) 2: S-curve (Strong)	-	-	Y	Y	0
H08	Rotational Direction Limitation	0: Disable 1: Enable (Reverse rotation inhibited) 2: Enable (Forward rotation inhibited)	-	-	N	Y	0
H11	Deceleration Mode	0: Normal deceleration 1: Coast-to-stop	-	-	Y	Y	0
H12	Instantaneous Overcurrent Limiting (Mode selection)	0: Disable 1: Enable	-	-	Y	Y	1
H13	Restart Mode after Momentary Power Failure (Restart time)	0.1 to 10.0	0.1	s	Y	Y1 Y2	0.5
H14	(Frequency fall rate)	0.00 0.01 to 100.00 999	0.01	Hz/s	Y	Y	999
H15	(Continuous running level) *1	200 to 300 (for 200 V class series) 400 to 600 (for 400 V class series)	1	V	Y	Y2	235 470
H26	Thermistor for Motor (Mode selection)	0: Disable 1: Enable (With PTC, the inverter immediately trips with Oh-4 displayed.) 2: Enable (With PTC, the inverter issues output signal THM and continues to run.)	-	-	Y	Y	0
H27	(Level)	0.00 to 5.00	0.01	V	Y	Y	1.6
H30	Communications Link Function (Mode selection)	Frequency command Run command 0: F01/C30 F02 1: RS-485 F02 2: F01/C30 RS-485 3: RS-485 RS-485	-	-	Y	Y	0
H44	Startup Counter of Motor 1	Indication of cumulative startup count (0000 to FFFF in hex.)	-	-	Y	N	-
H45	Mock Alarm	0: Disable 1: Enable (Once a mock alarm occurs, the data automatically returns to 0.)	-	-	Y	N	0

(H codes continued)

Code	Name	Data setting range	Increment	Unit	Change when running	Data copying	Default setting
H50	Non-linear V/f Pattern 1 (Frequency)	0.0 (Cancel), 0.1 to 400.0	0.1	Hz	N	Y	0.0
H51	(Voltage)	0 to 240: Output an AVR-controlled voltage (for 200 V class series) 0 to 500: Output an AVR-controlled voltage (for 400 V class series)	1	V	N	Y2	0.0
H52	Non-linear V/f Pattern 2 (Frequency)	0.0 (Cancel), 0.1 to 400.0	0.1	Hz	N	Y	0.0
H53	(Voltage)	0 to 240: Output an AVR-controlled voltage (for 200 V class series) 0 to 500: Output an AVR-controlled voltage (for 400 V class series)	1	V	N	Y2	0
H54	ACC/DEC Time (Jogging operation)	0.00 to 3600	0.01	s	Y	Y	6.00
H61	UP/DOWN Control (Initial frequency setting)	0: 0.00 1: Last UP/DOWN command value on releasing a run command	-	-	N	Y	1
H63	Low Limiter (Mode selection)	0: Limit by F16 (Frequency limiter: Low) and continue to run 1: If the output frequency lowers below the one limited by F16 (Frequency limiter: Low), decelerate to stop the motor.	-	-	Y	Y	0
H64	(Lower limiting frequency)	0.0 (Depends on F16 (Frequency limiter: Low)) 0.1 to 60.0	0.1	Hz	Y	Y	2.0
H69	Automatic Deceleration (Anti-regenerative control) (Mode selection)	0: Disable 1: Enable 2: Enable (Torque limit control: Disable force-to-stop processing.)	-	-	Y	Y	0
H70	Overload Prevention Control	0.00: Follow deceleration time specified by F08/E11 0.01 to 100.0, 999 (Cancel)	0.01	Hz/s	Y	Y	999
H71	Deceleration Characteristics	0: Disable 1: Enable	-	-	Y	Y	0
H76	Automatic Deceleration (Frequency increment limit for braking)	0.0 to 400.0	0.1	Hz	Y	Y	5.0
H78	Maintenance Interval *1	0: Disable, 1 to 9999 (in units of 10 hours)	1	-	Y	N	8760
H79	Preset Startup Count for Maintenance *1	0000: Disable, 0001 to FFFF (hex.)	1	-	Y	N	0000
H80	Output Current Fluctuation Damping Gain for Motor 1	0.00 to 0.40	0.01	-	Y	Y	0.20

(H codes continued)

Code	Name	Data setting range	Increment	Unit	Change when running	Data copying	Default setting
H89	Electronic Thermal Overload Protection for Motor (Data retention)	0: Disable 1: Enable	-	-	Y	Y	1
H91	PID Feedback Wire Break Detection (Terminal [C1])	0.0: Disable alarm detection 0.1 to 60.0: After the specified time, cause alarm	0.1	s	Y	Y	0.0
H92	Continuity of Running *1 (P)	0.000 to 10.000 times; 999	0.001	times	Y	Y1 Y2	999
H93	(I)	0.010 to 10.000 s; 999	0.001	s	Y	Y1 Y2	999
H94	Cumulative Run Time of Motor 1	0 to 9999 (in units of 10 hours)	-	-	N	N	-
H95	DC Braking (Braking response mode)	0: Slow 1: Quick	-	-	Y	Y	0
H96	STOP Key Priority/Start Check Function	Data STOP key priority Start check function 0: Disable Disable 1: Enable Disable 2: Disable Enable 3: Enable Enable	-	-	Y	Y	ACE:0 U:3
H97	Clear Alarm Data	0: Disable 1: Clear alarm data	-	-	Y	N	0
H98	Protection/Maintenance Function (Mode selection)	Bit 0: Lower the carrier frequency automatically (0: Disable; 1: Enable) Bit 1: Detect input phase loss (0: Disable; 1: Enable) Bit 2: Detect output phase loss (0: Disable; 1: Enable)	-	-	Y	Y	19

J codes: Application Functions

Code	Name	Data setting range	Increment	Unit	Change when running	Data copying	Default setting
J01	PID Control (Mode selection)	0: Disable 1: Enable (Process control, normal operation) 2: Enable (Process control, inverse operation)	-	-	N	Y	0
J02	(Remote command SV)	0: UP/DOWN keys on keypad 1: PID process command 1 (Analog input terminals [12] and [C1]) 3: Terminal command UP/DOWN control 4: Command via communications link	-	-	N	Y	0
J03	P (Gain) I	0.000 to 30.000 *1	0.001	times	Y	Y	0.100
J04	(Integral time)	0.0 to 3600.0 *1	0.1	s	Y	Y	0.0
J05	D (Differential time)	0.00 to 600.00 *1	0.01	s	Y	Y	0.00
J06	(Feedback filter)	0.0 to 900.0	0.1	s	Y	Y	0.5
J15	(Operation level for slow flowrate stop)	0.0 (Disable), 1.0 to 400.0	0.1	Hz	Y	Y	0.0
J16	(Elapsed time from slow flowrate stop)	0 to 3600	1	s	Y	Y	30
J17	(Initiation frequency)	0.0 to 400.0	0.1	Hz	Y	Y	0.0
J23	(Initiation deviation level for slow flowrate stop)	0.0 to 100.0	0.1	%	Y	Y	0.0
J24	(Start latency time for slow flowrate stop)	0 to 3660	1	s	Y	Y	0
J90	Traverse selection	0: Disabled 1: Enabled	1	-	Y	Y	0
J91	Traverse acceleration time	0.1 to 120.0 sec	0.1	s	Y	Y	25.0
J92	Traverse deceleration time	0.1 to 120.0 sec	0.1	s	Y	Y	25.0
J93	Traverse step	0.0 to 25.0%	0.1	%	Y	Y	10.0
J94	Traverse jump step	0.0 to 50.0%	0.1	%	Y	Y	10.0
J95	Traverse up offset	0.0 to 20.0%	0.1	%	Y	Y	0.0
J96	Traverse down offset	0.0 to 20.0%	0.1	%	Y	Y	0.0

*1 When you make settings from the keypad, the incremental unit is restricted by the number of digits that the LED monitor can display.

(Example) If the setting range is from -200.00 to 200.00, the incremental unit is:

"1" for -200 to -100, "0.1" for -99.9 to -10.0 and for 100.0 to 200.0, and "0.01" for -9.99 to -0.01 and for 0.00 to 99.99.

Table A Standard Motor Parameters



Power supply voltage	Applicable motor rating (kW)	Inverter type	standard torque boost (%)	Nominal rated current of standard motor (A)	Nominal rated capacity of standard motor (kW)	Restart mode after momentary power failure (Restart time) (s)
			Function code F09	Function codes F11/E34/E37	Function code P02	Function code H13
Three-phase 400 V	0.4	U1-0040-4	7.1	1.06	0.40	0.5
	0.75	U1-0075-4	6.8	1.68	0.75	
	1.5	U1-0150-4	6.8	2.99	1.50	
	2.2	U1-0220-4	6.8	4.40	2.20	
	3.7	U1-0370-4	5.5	7.19	3.70	
Single-phase 200 V	0.4	U1-0040-7	7.1	2.11	0.40	0.5
	0.75	U1-0075-7	6.8	3.37	0.75	
	1.5	U1-0150-7	6.8	5.87	1.50	
	2.2	U1-0220-7	6.8	8.80	2.20	









5.2 Details of Function Codes

This section provides the details of the function codes frequently used for the iMaster-U1 of inverters.

 For details about the function codes given below and other function codes not given below.

F00 Data Protection

F00 specifies whether to protect function code data (except F00) and digital reference data (such as frequency command, PID command and timer operation) from accidentally getting changed by pressing the  /  keys.

Data for F00	Function
0	Disable both data protection and digital reference protection, allowing you to change both function code data and digital reference data with the  /  keys.
1	Enable data protection and disable digital reference protection, allowing you to change digital reference data with the  /  keys. But you cannot change function code data (except F00).
2	Disable data protection and enable digital reference protection, allowing you to change function code data with the  /  keys. But you cannot change digital reference data.
3	Enable both data protection and digital reference protection, not allowing you to change function code data or digital reference data with the  /  keys.

Enabling the protection disables the  /  keys to change function code data.

To change F00 data, simultaneous keying of  +  (from 0 to 1) or  +  (from 1 to 0) keys is required.







Even when F00 = 1 or 3, function code data can be changed via the communications link.

For similar purposes, **WE-KP**, a signal enabling editing of function code data from the keypad is provided as a terminal command for digital input terminals. (Refer to the descriptions of E01 through E03.)

F01, C30 Frequency Command 1, Frequency Command 2

F01 or C30 sets the command source that specifies reference frequency 1 or reference frequency 2, respectively.

Data for F01, C30	Function
0	Enable  /  keys on the keypad. (Refer to Chapter 3 "OPERATION USING THE KEYPAD.")
1	Enable the voltage input to terminal [12] (0 to +10 VDC, maximum frequency obtained at +10 VDC).

Data for F01, C30	Function
2	Enable the current input to terminal [C1] (+4 to +20 mA DC or 0 to +20 mA DC, maximum frequency obtained at +20 mA DC).  Using function code C40 expands the input range from "+4 to +20 mA DC" to "0 to +20 mA DC."
3	Enable the sum of voltage (0 to +10 VDC, maximum frequency obtained at +10 VDC) and current inputs (+4 to +20 mA DC or 0 to +20 mA DC, maximum frequency obtained at +20 mA DC) given to terminals [12] and [C1], respectively.  Using function code C40 expands the input range from "+4 to +20 mA DC" to "0 to +20 mA DC." Note: If the sum exceeds the maximum frequency (F03, A01), the maximum frequency will apply.
4	Enable the built-in potentiometer (POT). (Maximum frequency obtained at full scale of the POT)
7	Enable UP and DOWN commands assigned to the digital input terminals. The UP and DOWN should be assigned to any of digital input terminals [X1] to [X3] beforehand with any of E01 to E03 (data = 17 and 18).



Note

In addition to the frequency command sources described above, higher priority command sources including communications link and multistep frequency are provided.









Tip

- For frequency settings made by terminals [12] (voltage) and [C1] (current) and by the built-in potentiometer, setting the gain and bias changes the relationship between those frequency settings and the drive frequency. Refer to function code F18 for details.
- For the inputs to terminals [12] (voltage) and [C1] (current), low-pass filters can be enabled.
- Using the terminal command **H_{z2}/H_{z1}** assigned to one of the digital input terminals switches between frequency command 1 (F01) and frequency command 2 (C30). Refer to function codes E01 to E03.

F02 Operation Method

F02 selects the source that specifies a run command for running the motor.

Data for F02	Run Command Source	Description
0	Keypad (Rotation direction specified by terminal command)	Enable the  /  keys to run and stop the motor. The rotation direction of the motor is specified by terminal command FWD or REV .
1	External signals	Enable terminal command FWD or REV to run and stop the motor.
2	Keypad (Forward rotation)	Enable  /  keys to run and stop the motor. Note that this run command enables only the forward rotation. There is no need to specify the rotation direction.

Data for F02	Run Command Source	Description
3	Keypad (Reverse rotation)	Enable  /  keys to run and stop the motor. Note that this run command enables only the reverse rotation. There is no need to specify the rotation direction.



- When function code F02 = 0 or 1, the "Run forward" **FWD** and "Run reverse" **REV** terminal commands must be assigned to terminals [FWD] and [REV], respectively.
- When the **FWD** or **REV** is ON, the F02 data cannot be changed.
- When assigning the **FWD** or **REV** to terminal [FWD] or [REV] with F02 being set to "1," be sure to turn the target terminal OFF beforehand; otherwise, the motor may unintentionally rotate.
- In addition to the run command sources described above, higher priority command sources including communications link are provided.

F03 Maximum Frequency 1

F03 specifies the maximum frequency (for motor 1) to limit the output frequency. Specifying the maximum frequency exceeding the rating of the equipment driven by the inverter may cause damage or a dangerous situation. Make sure that the maximum frequency setting matches the equipment rating.

WARNING

The inverter can easily accept high-speed operation. When changing the speed setting, carefully check the specifications of motors or equipment beforehand.

Otherwise injuries could occur.



Tip Modifying F03 data to allow a higher reference frequency requires also changing F15 data specifying a frequency limiter (high).

F04	Base Frequency 1
F05	Rated Voltage at Base Frequency 1
F06	Maximum Output Voltage 1
H50, H51	Non-linear V/f Pattern 1 (Frequency and Voltage)
H52, H53	Non-linear V/f Pattern 2 (Frequency and Voltage)

■ Base Frequency 1 (F04)

Set the rated frequency printed on the nameplate labeled on the motor.

■ Rated Voltage at Base Frequency (F05)

Set "0" or the rated voltage printed on the nameplate labeled on the motor.

- If "0" is set, the rated voltage at base frequency is determined by the power source of the inverter. The output voltage will vary in line with any variance in input voltage.
- If the data is set to anything other than "0," the inverter automatically keeps the output voltage constant in line with the setting. When any of the auto torque boost settings, auto energy saving or slip compensation is active, the voltage settings should be equal to the rated voltage of the motor.

■ Non-linear V/f Patterns 1 and 2 for Frequency (H50 and H52)

Set the frequency component at an arbitrary point of the non-linear V/f pattern.
(Setting "0.0" to H50 or H52 disables the non-linear V/f pattern operation.)

■ Non-linear V/f Patterns 1 and 2 for Voltage (H51 and H53)

Sets the voltage component at an arbitrary point of the non-linear V/f pattern.

■ Maximum Output Voltage (F06)

Set the voltage for the maximum frequency 1 (F03).



- If F05 (Rated Voltage at Base Frequency 1) is set to "0," settings of H50 through H53 and F06 do not take effect. (When the non-linear point is below the base frequency, the linear V/f pattern applies; when it is above, the output voltage is kept constant.)
- When the auto torque boost (F37) is enabled, the non-linear V/f pattern takes no effect.

Examples:

■ Normal (linear) V/f pattern

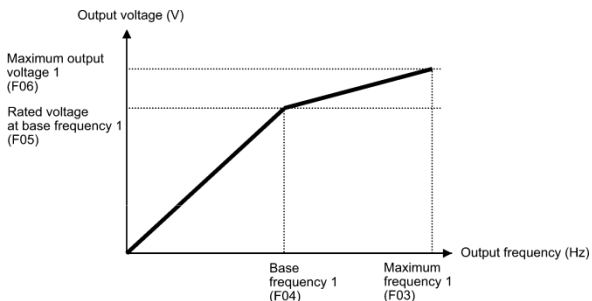

■ V/f pattern with two non-linear points

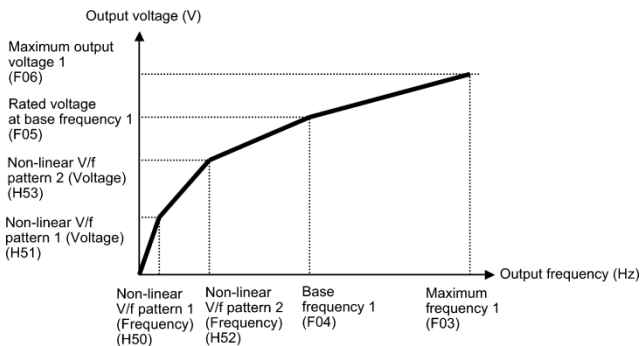

-
- F07 Acceleration Time 1
 - F08 Deceleration Time 1
 - E10 Acceleration Time 2
 - E11 Deceleration Time 2
-

F07 specifies the acceleration time, the length of time the frequency increases from 0 Hz to the maximum frequency. F08 specifies the deceleration time, the length of time the frequency decreases from the maximum frequency down to 0 Hz.

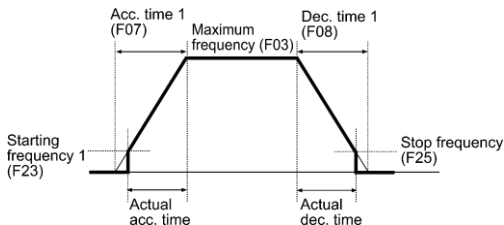

Note

- Selecting an S-shaped pattern or curvilinear acceleration/deceleration pattern with function code H07 (Acceleration/deceleration pattern) makes the actual acceleration/deceleration times longer than the specified ones. Refer to the descriptions of function code H07.
- Specifying an improperly short acceleration/deceleration time may activate the current limiter or anti-regenerative control, resulting in a longer acceleration/deceleration time than the specified one.

Tip

Acceleration/deceleration time 1 (F07, F08) and acceleration/deceleration time 2 (E10, E11) are switched by terminal command **RT1** assigned to any of the digital input terminals with any of function codes E01 through E03.

F37 specifies V/f pattern, torque boost type for optimizing the operation in accordance with the characteristics of the load. F09 specifies the type of torque boost in order to provide sufficient starting torque.

Data for F37	V/f pattern	Torque boost (F09)	Auto energy saving	Applicable load
0	Variable torque V/f pattern	Torque boost specified by F09	Disable	Variable torque load (General purpose fans and pumps)
1	Linear V/f pattern	Auto torque boost		Constant torque load
2				Constant torque load (To be selected if a motor may be over-excited at no load.)

Note: If a required "load torque + acceleration torque" is more than 50% of the rated torque, it is recommended to select the linear V/f pattern (factory default).

■ V/f characteristics

The iMaster-U1 of inverters offers a variety of V/f patterns and torque boosts, which include V/f patterns suitable for variable torque load such as general fans and pumps or for special pump load requiring high starting torque. Two types of torque boost are available: manual and automatic.

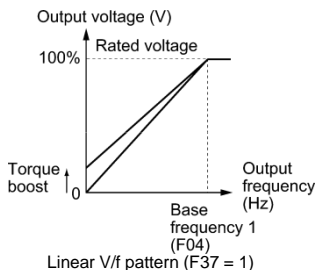
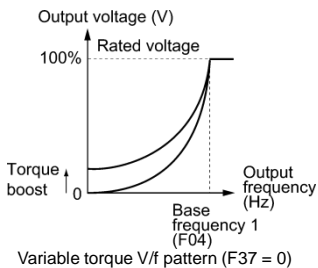

When the variable torque V/f pattern is selected (F37 = 0), the output voltage may be low and insufficient voltage output may result in less output torque of the motor at a low frequency zone, depending on some characteristics of the motor itself and load. In such a case, it is recommended to increase the output voltage at the low frequency zone using the non-linear V/f pattern (H50, H51).

Recommended value: H50 = 1/10 of the base frequency

H51 = 1/10 of the voltage at base frequency

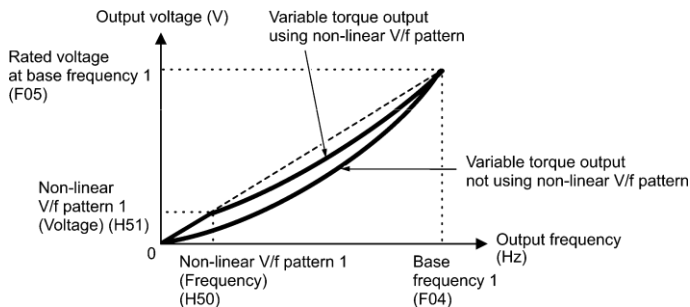

■ Torque boost

- Manual torque boost (F09)

In torque boost using F09, constant voltage is added to the basic V/f pattern, regardless of the load, to give the output voltage. To secure a sufficient starting torque, manually adjust the output voltage to optimally match the motor and its load by using F09. Specify an appropriate level that guarantees smooth start-up and yet does not cause over-excitation with no or light load.

Torque boost per F09 ensures high driving stability since the output voltage remains constant regardless of the load fluctuation.

Specify the F09 data in percentage to the rated voltage at base frequency 1 (F05). At factory shipment, F09 is preset to a level that provides approx. 100% of starting torque.

Note

Specifying a high torque boost level will generate a high torque, but may cause overcurrent due to over-excitation at no load. If you continue to drive the motor, it may overheat. To avoid such a situation, adjust torque boost to an appropriate level. When the non-linear V/f pattern and the torque boost are used together, the torque boost takes effect below the frequency on the non-linear V/f pattern's point.

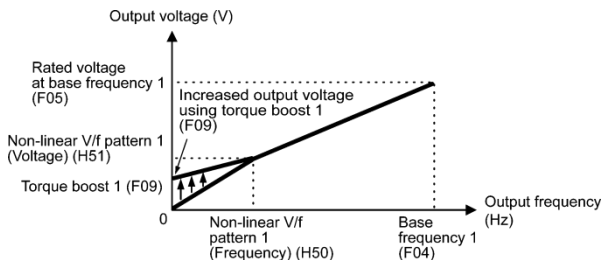

- Auto torque boost

This function automatically optimizes the output voltage to fit the motor with its load. Under light load, auto torque boost decreases the output voltage to prevent the motor from over-excitation. Under heavy load, it increases the output voltage to increase output torque of the motor.



- Since this function relies also on the characteristics of the motor, set the base frequency 1 (F04), the rated voltage at base frequency 1 (F05), and other pertinent motor parameters (P02, P03 and P06 through P99) in line with the motor capacity and characteristics, or else perform auto-tuning (P04).
- When a special motor is driven or the load does not have sufficient rigidity, the maximum torque might decrease or the motor operation might become unstable. In such cases, do not use auto torque boost but choose manual torque boost per F09 (F37 = 0 or 1).

F10	Electronic Thermal Overload Protection for Motor 1 (Select motor characteristics)
F11	Electronic Thermal Overload Protection for Motor 1 (Overload detection level)
F12	Electronic Thermal Overload Protection for Motor 1 (Thermal time constant)

F10 through F12 specify the thermal characteristics of the motor for its electronic thermal overload protection that is used to detect overload conditions of the motor.

F10 selects the motor cooling mechanism to specify its characteristics, F11 specifies the overload detection current, and F12 specifies the thermal time constant.



Thermal characteristics of the motor specified by F10 and F12 are also used for the overload early warning. Even if you need only the overload early warning, set these characteristics data to these function codes. To disable the electronic thermal overload protection, set function code F11 to "0.00."

■ Motor characteristics (F10)

F10 selects the cooling mechanism of the motor-- shaft-driven or separately powered cooling fan.

Data for F10	Function
1	For a general-purpose motor and Fuji standard permanent magnet synchronous motor with shaft-driven cooling fan. (The cooling effect will decrease in low frequency operation.)
2	For an inverter-driven motor with separately powered cooling fan. (The cooling effect will be kept constant regardless of the output frequency.)

The figure below shows operating characteristics of the electronic thermal overload protection when F10 = 1. The characteristic factors α_1 through α_3 as well as their corresponding switching frequencies f_2 and f_3 vary with the characteristics of the motor.

The tables below list the factors determined by the motor capacity (P02) and the motor characteristics (P99).

Actual Output Current (Continuous)
Overload Detection Level (F11) (%)

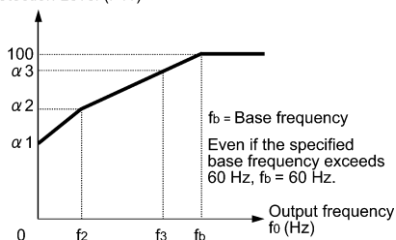

Cooling Characteristics of Motor with Shaft-driven Cooling Fan

Nominal Applied Motor and Characteristic Factors when P99 (Motor 1 selection) = 0 or 4

Nominal applied motor (kW)	Thermal time constant τ (Factory default)	Reference current for setting the thermal time constant (I_{max})	Output frequency for motor characteristic factor		Characteristic factor		
			f2	f3	$\alpha 1$	$\alpha 2$	$\alpha 3$
0.1 to 0.75	5 min	Allowable continuous current $\times 150\%$	5 Hz	7 Hz	75%	85%	100%
1.5 to 4.0					85%	85%	100%
5.5 to 11					90%	95%	100%
15					85%	85%	100%
18.5, 22					92%	100%	100%
30	10 min		Base frequency $\times 33\%$	Base frequency $\times 33\%$	54%	85%	90%

When F10 = 2, the cooling effect is not decreased by the output frequency so that the overload detection level is a constant value without reduction (F11).

■ Overload detection level (F11)

F11 specifies the detection level (in amperes) at which the electronic thermal overload protection becomes activated.

In general, set F11 to the rated current of motor when driven at the base frequency (i.e. 1.0 to 1.1 multiple of the rated current of motor 1 (P03)). To disable the electronic thermal overload protection, set F11 to "0.00: Disable."

■ Thermal time constant (F12)

F12 specifies the thermal time constant of the motor. If the current of 150% of the overload detection level specified by F11 flows for the time specified by F12, the electronic thermal overload protection becomes activated to detect the motor overload. The thermal time constant for general-purpose motors including Fuji motors is approx. 5 minutes by factory default.

- Data setting range: 0.5 to 75.0 (minutes) in increments of 0.1 (minute)

(Example) When the F12 data is set at "5.0" (5 minutes)

As shown below, the electronic thermal overload protection is activated to detect an alarm condition (alarm code OL1) when the output current of 150% of the overload detection level (specified by F11) flows for 5 minutes, and 120% for approx. 12.5 minutes.

The actual time required for issuing a motor overload alarm tends to be shorter than the specified value, taking into account the time period from when the output current exceeds the allowable continuous drive current (100%) until it reaches 150% of the overload detection level.

Example of Thermal Overload Detection Characteristics

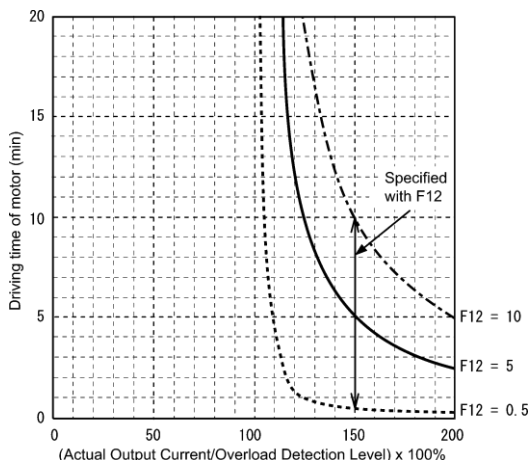

F14	Restart Mode after Momentary Power Failure
H13	Restart Mode after Momentary Power Failure, Restart time
H14	Restart Mode after Momentary Power Failure, Frequency fall rate

F14 specifies the action to be taken by the inverter such as trip and restart in the event of a momentary power failure.

■ Restart mode after momentary power failure (Mode selection) (F14)

Data for F14	Mo	Description
0	Disable restart (Trip immediately)	As soon as the DC link bus voltage drops below the under voltage detection level due to a momentary power failure, the inverter issues under voltage alarm LU and shuts down its output so that the motor enters a coast-to-stop state.
1	Disable restart (Trip after recovery from power failure)	As soon as the DC link bus voltage drops below the under voltage detection level due to a momentary power failure, the inverter shuts down its output so that the motor enters a coast-to-stop state, but it does not enter the under voltage state or issue under voltage alarm LU . The moment the power is restored, an under voltage alarm LU is issued, while the motor remains in a coast-to-stop state.

Data for F14	Mode	Descri
2	Trip after decelerate-to-stop	As soon as the DC link bus voltage drops below the continuous running level due to a momentary power failure, decelerate-to-stop control is invoked. Decelerate-to-stop control regenerates kinetic energy from the load's moment of inertia, slowing down the motor and continuing the deceleration operation. After decelerate-to-stop operation, an under voltage alarm LU is issued. (Available in the ROM version 0500 or later.)
4	Enable restart (Restart at the frequency at which the power failure occurred, for general loads)	As soon as the DC link bus voltage drops below the under voltage detection level due to a momentary power failure, the inverter saves the output frequency being applied at that time and shuts down the output so that the motor enters a coast-to-stop state. If a run command has been input, restoring power restarts the inverter at the output frequency saved during the last power failure processing. This setting is ideal for applications with a moment of inertia large enough not to slow down the motor quickly, such as fans, even after the motor enters
5	Enable restart (Restart at the starting frequency, for low-inertia load)	After a momentary power failure, restoring power and then entering a run command restarts the inverter at the starting frequency specified by function code F23. This setting is ideal for heavy load applications such as pumps, having a small moment of inertia, in which the motor speed quickly goes down to zero as soon as it enters a coast-to-stop state

WARNING

If you enable the "Restart mode after momentary power failure" (Function code F14 = 4 or 5), the inverter automatically restarts the motor running when the power is restored. Design the machinery or equipment so that human safety is ensured after restarting.

Otherwise an accident could occur.

■ Restart mode after momentary power failure (Basic operation)

The inverter recognizes a momentary power failure upon detecting the condition that DC link bus voltage goes below the under voltage detection level, while the inverter is running. If the load of the motor is light and the duration of the momentary power failure is extremely short, the voltage drop may not be great enough for a momentary power failure to be recognized, and the motor may continue to run uninterrupted.

Upon recognizing a momentary power failure, the inverter enters the restart mode (after a recovery from momentary power failure) and prepares for restart. When power is restored, the inverter goes through an initial charging stage and enters the ready-to-run state. When a momentary power failure occurs, the power supply voltage for external circuits such as relay sequence circuits may also drop so as to turn the run command OFF. In consideration of such a situation, the inverter waits 2 seconds for a run command input after the inverter enters a ready-to-run state. If a run command is received within 2 seconds, the inverter begins the restart processing in accordance with the F14 data (Mode selection). If no run command has been received within 2-second wait period, the inverter cancels the restart mode (after a recovery from momentary power failure) and needs to be started again from the ordinary starting frequency. Therefore, ensure that a run command is entered within 2 seconds after a recovery of power, or install a mechanical latch relay.

When run commands are entered via the keypad, the above operation is also necessary for the mode (F02 = 0) in which the rotational direction is determined by the terminal command, **FWD** or **REV**. In the modes where the rotational direction is fixed (F02 = 2 or 3), it is retained inside the inverter so that the restart will begin as soon as the inverter enters the ready-to-run state.

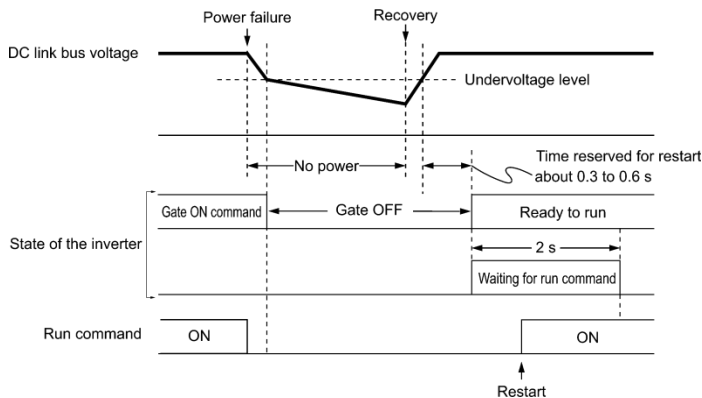

If the "Coast to a stop" terminal command **BX** is entered during the power failure, the inverter gets out of the restart mode and enters the normal running mode. If a run command is entered with power supply applied, the inverter will start from the normal starting frequency (F23).

During a momentary power failure, the motor slows down. After power is restored, the inverter restarts at the frequency just before the momentary power failure. Then, the current limiting function works and the output frequency of the inverter automatically decreases. When the output frequency matches the motor speed, the motor accelerates up to the original output frequency. See the figure below. In this case, the instantaneous overcurrent limiting must be enabled (H12 = 1).

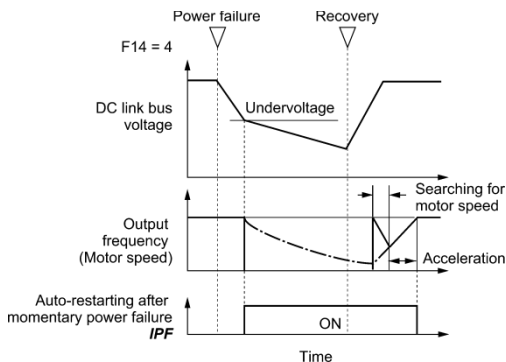

■ Restart mode after momentary power failure (Restart time) (H13)

H13 specifies the time period from momentary power failure occurrence until the inverter reacts for restarting process.

If the inverter starts the motor while motor's residual voltage is still in a high level, a large inrush current may flow or an overvoltage alarm may occur due to an occurrence of temporary regeneration. For safety, therefore, it is advisable to set H13 to a certain level so that restart will take place only after the residual voltage has dropped to a low level. Note that even when power is restored, restart will not take place until the restart time (H13) has elapsed.

Factory default

By factory default, H13 is set at one of the values shown below according to the inverter capacity. Basically, you do not need to change H13 data. However, if the long restart time causes the flow rate of the pump to overly decrease or causes any other problem, you might as well reduce the setting to about a half of the default value. In such a case, make sure that no alarm occurs.

Inverter capacity (kW)	Factory default of H13 (Restart time in seconds)
0.1 to 7.5	0
11 to 15	1

■ Restart mode after momentary power failure (Frequency fall rate) (H14)

During restart after a momentary power failure, if the inverter output frequency and the idling motor speed cannot be harmonized with each other, an overcurrent will flow, activating the overcurrent limiter. If it happens, the inverter reduces the output frequency to match the idling motor speed according to the reduction rate (Frequency fall rate: Hz/s) specified by H14.

Data for H14	Inverter's action for the output frequency fall
0.00	Follow the selected deceleration time
0.01 to 100.00 (Hz/s)	Follow data specified by H14
999	Follow the setting of the PI processor in the current limiter. (The PI constant is prefixed inside the inverter.)

Note

If the frequency fall rate is too high, regeneration may take place at the moment the motor rotation matches the inverter output frequency, causing an overvoltage trip. On the contrary, if the frequency fall rate is too low, the time required for the output frequency to match the motor speed (duration of current limiting action) may be prolonged, triggering the inverter overload prevention control.

F15, F16 Frequency Limiter (High and Low)

H63 Low Limiter (Mode selection)

F15 and F16 specify the upper and lower limits of the output frequency, respectively.

H63 specifies the operation to be carried out when the output frequency drops below the low level specified by F16, as follows:

- When H63 = 0, the output frequency will be held at the low level specified by F16.
- When H63 = 1, the inverter decelerates to stop the motor.

Note

- When you change the frequency limiter (High) (F15) in order to raise the reference frequency, be sure to change the maximum frequency (F03, A01) accordingly.
- Maintain the following relationship among the data for frequency control:
F15 > F16, F15 > F23(A12), and F15 > F25
F03/A01 > F16
where, F23(A12) is of the starting frequency and F25 is of the stop frequency.
If you specify any wrong data for these function codes, the inverter may not run the motor at the desired speed, or cannot start it normally.

F18	Bias (Frequency command 1)
C50	Bias (for Frequency 1) (Bias base point)
C32, C34	Analog Input Adjustment for [12] (Gain, Gain base point)
C37, C39	Analog Input Adjustment [C1] (Gain, Gain base point)

When any analog input for frequency command 1 (F01) is used, it is possible to define the relationship between the analog input and the reference frequency by multiplying the gain and adding the bias specified by F18.

As shown in the graph below, the relationship between the analog input and the reference frequency specified by frequency command 1 is determined by points "A" and "B." Point "A" is defined by the combination of the bias (F18) and its base point (C50); Point "B," by the combination of the gain (C32, C37) and its base point (C34, C39).

The combination of C32 and C34 applies to terminal [12] and that of C37 and C39, to terminal [C1].

Configure the bias (F18) and gain (C32, C37), assuming the maximum frequency as 100%, and the bias base point (C50) and gain base point (C34, C39), assuming the full scale (10 VDC or 20 mA DC) of analog input as 100%.

Note

- The analog input less than the bias base point (C50) is limited by the bias value(F18).
- Specifying that the data of the bias base point (C50) is equal to or greater than that of each gain base point (C34, C39) will be interpreted as invalid, so the inverter will reset the reference frequency to 0 Hz.

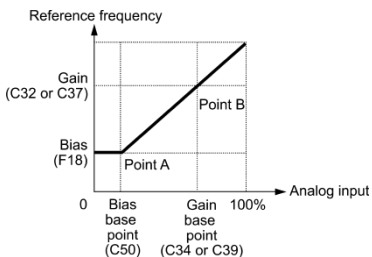

Example: Setting the bias, gain and their base points when the reference frequency 0 to 100% follows the analog input of 1 to 5 VDC to terminal [12] (in frequency command 1).

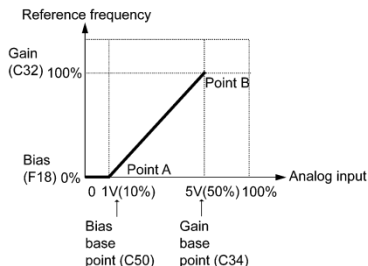

(Point A)

To set the reference frequency to 0 Hz for an analog input being at 1 V, set the bias to 0% (F18 = 0). Since 1 V is the bias base point and it is equal to 10% of 10 V (full scale), set the bias base point to 10% (C50 = 10).

(Point B)

To make the maximum frequency equal to the reference frequency for an analog input being at 5 V, set the gain to 100% (C32 = 100). Since 5 V is the gain base point and it is equal to 50% of 10 V (full scale), set the gain base point to 50% (C34 = 50).



The setting procedure for specifying a gain or bias alone without changing any base points is the same as that of ADT conventional inverters.

F20 to F22 DC Braking 1 (Braking starting frequency, Braking level, and Braking time)
 H95 DC Braking (Braking response mode)

F20 through F22 specify the DC braking that prevents motor 1 from running by inertia during decelerate-to-stop operation.

If the motor enters a decelerate-to-stop operation by turning OFF the run command or by decreasing the reference frequency below the stop frequency, the inverter activates the DC braking by flowing a current at the braking level (F21) during the braking time (F22) when the output frequency reaches the DC braking starting frequency (F20).

Setting the braking time (F22) to "0.00" disables the DC braking.

■ Braking starting frequency (F20)

F20 specifies the frequency at which the DC braking starts its operation during motor decelerate-to-stop state.



Generally, set the motor rated slip frequency or so to F20. Setting an extremely large value makes the control unstable; according to conditions, it activates an overvoltage protection.

■ Braking level (F21)

F21 specifies the output current level to be applied when the DC braking is activated. The function code data should be set, assuming the rated output current of the inverter as 100%, in increments of 1%.

[Conversion formula]

$$\text{Setting value (\%)} = \frac{I_{DB} \text{ (A)}}{I_{ref} \text{ (A)}} \times 100$$

Example: If setting I_{DB} (A) of 4.2 A with standard applicable motor capacity of 0.75 kW

$$\text{Setting value (\%)} = \frac{4.2 \text{ (A)}}{5.0 \text{ (A)}} \times 100 = 84$$

■ Braking time (F22)

F22 specifies the braking period that activates DC braking.

■ Braking response mode (H95)

H95 specifies the DC braking response mode.

Data for H95	Characteristics	Note
0	Slow response. Slows the rising edge of the current, thereby preventing reverse rotation at the start of DC braking.	Insufficient braking torque may result at the start of DC braking.
1	Quick response. Quickens the rising edge of the current, thereby accelerating the build-up of the braking torque.	Reverse rotation may result depending on the moment of inertia of the mechanical load and the coupling mechanism.



Tip

It is also possible to use an external digital input signal as an "Enable DC braking" terminal command **DCBRK**.

As long as the **DCBRK** command is ON, the inverter performs DC braking, regardless of the braking time specified by F22.

Turning the **DCBRK** command ON even when the inverter is in a stopped state activates DC braking. This feature allows the motor to be excited before starting, resulting in smoother acceleration (quicker build-up of acceleration torque).

CAUTION

The DC brake function of the inverter does not provide any holding mechanism.
Injuries could occur.

F23	Starting Frequency 1
F24	Starting Frequency 1 (Holding time)
F25	Stop Frequency
F39	Stop Frequency (Holding time)

At the startup of an inverter, the initial output frequency is equal to the starting frequency 1 specified by F23. The inverter stops its output when the output frequency reaches the stop frequency specified by F25.

Set the starting frequency to a level at which the motor can generate enough torque for startup. Generally, set the motor's rated slip frequency as the starting frequency.

In addition, to compensate for the delay time for the establishment of a magnetic flux in the motor, F24 specifies the holding time for the starting frequency. To stabilize the motor speed at the stop of the motor, F39 specifies the holding time for the stop frequency.



Note If the starting frequency is lower than the stop frequency, the inverter will not output any power as long as the reference frequency does not exceed the stop frequency.

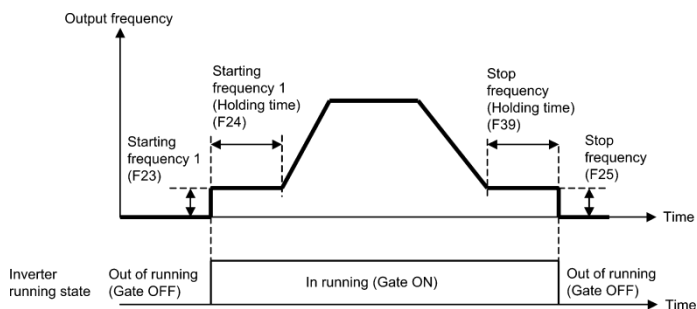

■ Motor sound (Carrier frequency) (F26)

F26 controls the carrier frequency so as to reduce an audible noise generated by the motor or electromagnetic noise from the inverter itself, and to decrease a leakage current from the main output (secondary) wirings.

Carrier frequency	0.75 to 16 kHz
Motor sound noise emission	High ↔ Low
Motor temperature (due to harmonics components)	High ↔ Low
Ripples in output current waveform	Large ↔ Small
Leakage current	Low ↔ High
Electromagnetic noise emission	Low ↔ High
Inverter loss	Low ↔ High

Note

Specifying a too low carrier frequency will cause the output current waveform to have a large amount of ripples. As a result, the motor loss increases, causing the motor temperature to rise. Furthermore, the large amount of ripples tends to cause a current limiting alarm. When the carrier frequency is set to 1 kHz or below, therefore, reduce the load so that the inverter output current comes to be 80% or less of the rated current.

When a high carrier frequency is specified, the temperature of the inverter may rise due to an ambient temperature rise or an increase of the load. If it happens, the inverter automatically decreases the carrier frequency to prevent the inverter overload alarm OLU. With consideration for motor noise, the automatic reduction of carrier frequency can be disabled. Refer to the description of H98.

■ Motor sound (Tone) (F27)

F27 changes the motor running sound tone. This setting is effective when the carrier frequency set to function code F26 is 7 kHz or lower. Changing the tone level may reduce the high and harsh running noise from the motor.

Note

If the sound level is set too high, the output current may become unstable, or mechanical vibration and noise may increase. Also, these function codes may not be very effective for certain types of motor.

F30	Analog Output [FMA] (Voltage adjustment)
F31	Analog Output [FMA] (Function)

These function codes allow terminal [FMA] to output monitored data such as the output frequency and the output current in an analog DC voltage. The magnitude of the output voltage is adjustable.

■ Voltage adjustment (F30)

F30 adjusts the output voltage representing the monitored data selected by F31 within the range of 0 to 300%.

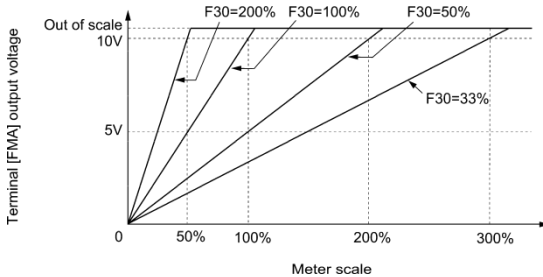

■ Function (F31)

F31 specifies what is output to analog output terminal [FMA].

Data for F31	[FM] output	Function (Monitor the following)	Meter scale (Full scale at 100%)
0	Output frequency (before slip compensation)	Output frequency of the inverter (Equivalent to the motor synchronous speed)	Maximum frequency (F03)
1	Output frequency (after slip compensation)	Output frequency of the inverter	Maximum frequency (F03)
2	Output current	Output current (RMS) of the inverter	Twice the inverter rated current
3	Output voltage	Output voltage (RMS) of the inverter	250 V for 200 V class series, 500 V for 400 V class series
7	PID feedback amount	Feedback amount under PID control	100% of the feedback amount
9	DC link bus voltage	DC link bus voltage of the inverter	500 V for 200 V class series, 1000 V for 400 V class series
14	Calibration	Full scale output of the meter calibration	This always outputs +10 VDC (FMA function).
15	PID command (SV)	Command value under PID control	100% of the PID command value
16	PID output (MV)	Output level of the PID controller under PID control (Frequency command)	Maximum frequency (F03, A01)

F42 specifies the control mode of the inverter to control a motor.

Data for F42	Control mode
0	V/f control with slip compensation inactive
1	Dynamic torque vector control
2	V/f control with slip compensation active

■ V/f control

In this control, the inverter controls a motor by the voltage and frequency according to the V/f pattern specified by function codes.

■ Slip compensation

Applying any load to an induction motor causes a rotational slip due to the motor characteristics, decreasing the motor rotation. The inverter's slip compensation facility first presumes the slip value of the motor based on the motor torque generated and raises the output frequency to compensate for the decrease in motor rotation. This prevents the motor from decreasing the rotation due to the slip.

That is, this facility is effective for improving the motor speed control accuracy.

The compensation value is specified by combination of function codes P12 (Rated slip frequency), P09 (Slip compensation gain for driving) and P11 (Slip compensation gain for braking).

■ Dynamic torque vector control

To get the maximal torque out of a motor, this control calculates the motor torque for the load applied and uses it to optimize the voltage and current vector output.

This control is effective for improving the system response against external disturbances and the motor speed control accuracy.

When the output current of the inverter exceeds the level specified by the current limiter (F44), the inverter automatically manages its output frequency to prevent a stall and limit the output current. (Refer to the description of function code H12.)

If F43 = 1, the current limiter is enabled only during constant speed operation. If F43 = 2, the current limiter is enabled during both of acceleration and constant speed operation. Choose F43 = 1 if you need to run the inverter at full capability during acceleration and to limit the output current during constant speed operation.

Note

The F44 setting value is converted from current braking operation level current limit (A) based on reference current I_{ref} (A). Set the value obtained from the following conversion formula.

[Conversion formula]

$$\text{Setting value (\%)} = \frac{I_{\text{limit}} \text{ (A)}}{I_{\text{ref}} \text{ (A)}} \times 100$$

Example: If setting I_{limit} (A) of 4.2 A with standard applicable motor capacity of 0.75 kW

$$\text{Setting value (\%)} = \frac{4.2 \text{ (A)}}{5.0 \text{ (A)}} \times 100 = 84$$

 Refer to the table for F20 to F22 for reference current.

■ Mode selection (F43)

F43 selects the motor running state in which the current limiter will be active.

Data for F43	Running states that enable the current limiter		
	During acceleration	During constant speed	During deceleration
0	Disable	Disable	Disable
1	Disable	Enable	Disable
2	Enable	Enable	Disable

■ Level (F44)

F44 specifies the operation level at which the output current limiter becomes activated, in ratio to the inverter rating.

Note

- Since the current limit operation with F43 and F44 is performed by software, it may cause a delay in control. If you need a quick response, specify a current limit operation by hardware (H12 = 1) at the same time.
- If an excessive load is applied when the current limiter operation level is set extremely low, the inverter will rapidly lower its output frequency. This may cause an overvoltage trip or dangerous turnover of the motor rotation due to undershooting.

A braking resistor can be mounted on inverters of 0.4 kW or above.

These function codes specify the electronic thermal overload protection feature for the braking resistor.

Set F50 and F51 data to the discharging capability and allowable average loss, respectively. Since those values differ depending on the specifications of the braking resistor, refer to the tables given below.



Depending on the thermal marginal characteristics of the braking resistor, the electronic thermal overload protection feature may act so that the inverter issues the overheat protection alarm dBH even if the actual temperature rise is not enough. If it happens, review the relationship between the performance index of the braking resistor and settings of related function codes.

The tables below list the discharging capability and allowable average loss of the braking resistor. These values depend upon the inverter and braking resistor models.

■ External Braking Resistors

Standard models

The thermal sensor relay mounted on the braking resistor acts as a thermal protector of the motor for overheat, so assign an "Enable external alarm trip" terminal command **THR** to any of digital input terminals [X1] to [X3], [FWD] and [REV] and connect that terminal and its common terminal to braking resistor's terminals 2 and 1.

To protect the motor from overheat without using the thermal sensor relay mounted on the braking resistor, configure the electronic thermal overload protection facility by setting F50 and F51 data to the discharging capability and allowable average loss values listed below, respectively.

Power supply voltage	Inverter type	Braking resistor		Resistance (Ω)	Continuous braking (100% braking torque)		Intermittent braking (Period: 100 s or less)	
		Type	Qty.		Discharging capacity (kW)	Braking time (s)	Allowable average loss (kW)	Duty (%ED)
Three-phase 400 V	U1-0040-4	DB0.75-4	1	200	9	45	0.044	22
	U1-0075-4				17		0.068	18
	U1-0150-4	DB2.2-4		160	34	0.075	10	
	U1-0220-4				33	30	0.077	7
	U1-0370-4	DB3.7-4		130	37	20	0.093	5
Single-phase 200 V	U1-0040-7	DB0.75-2	1	100	9	45	0.044	22
	U1-0075-7				17		0.068	18
	U1-0150-7	DB2.2-2		40	34	0.075	10	
	U1-0220-7				33	30	0.077	7

Compact models

When using the compact models of braking resistor TK80W120 Ω or TK80W100 Ω , set F50 to "7" and F51 to "0.033."

10% ED models

Power supply voltage	Inverter type	Braking resistor		Resistance (Ω)	Continuous braking (100% braking torque)		Intermittent braking (Period: 100 s or less)	
		Type	Qty.		Discharging capacity (kW)	Braking time (s)	Allowable average loss (kW)	Duty (%ED)
Three-phase 400 V	U1-0040-4	DB0.75-4C	1	200	50	250	0.075	37
	U1-0075-4					133		20
	U1-0150-4	DB2.2-4C		160	55	73	0.110	14
	U1-0220-4					50		10
	U1-0370-4	DB3.7-4C		130	140	75	0.185	
Single-phase 200 V	U1-0040-7	DB0.75-2C	1	100	50	250	0.075	37
	U1-0075-7					133		20
	U1-0150-7	DB2.2-2C		40	55	73	0.110	14
	U1-0220-7					50		10

E01 to E03 Terminal [X1] to [X3] Function

E98, E99 Terminal [FWD] and [REV] Function

Function codes E01 to E03, E98 and E99 allow you to assign commands to terminals [X1] to [X3], [FWD], and [REV] which are general-purpose, programmable, digital input terminals. These function codes may also switch the logic system between normal and negative to define how the inverter logic interprets either ON or OFF status of each terminal. The default setting is normal logic system "Active ON." So, explanations that follow are given in normal logic system "Active ON."

CAUTION

In the case of digital input, you can assign commands to the switching means for the run command and its operation and the reference frequency (e.g., **SS1**, **SS2**, **SS4**, **SS8**, **H2/Hz1**, **H2/PID**, **IVS**, and **LE**). Be aware that switching any of such signals may cause a sudden start (running) or an abrupt change in speed.

An accident or physical injury may result.

Function code data		Terminal commands assigned	Symbol
Active ON	Active OFF		
0	1000	Select multistep frequency (0 to 15 steps)	SS1
1	1001		SS2
2	1002		SS4
3	1003		SS8
4	1004	Select ACC/DEC time	RT1
6	1006	Enable 3-wire operation	HLD
7	1007	Coast to a stop	BX
8	1008	Reset alarm	RST
9	1009	Enable external alarm trip	THR
10	1010	Ready for jogging	JOG
11	1011	Select frequency command 2/1	H2/Hz1
13	—	Enable DC braking	DCBRK
17	1017	UP (Increase output frequency)	UP
18	1018	DOWN (Decrease output frequency)	DOWN
19	1019	Enable data change with keypad	WE-KP
20	1020	Cancel PID control	H2/PID
21	1021	Switch normal/inverse operation	IVS
24	1024	Enable communications link via RS-485	LE
33	1033	Reset PID integral and differential components	PID-RST
34	1034	Hold PID integral component	PID-HLD
90	1090	Traverse On	TRV
91	1091	Traverse Up Offset	TRV UP_OFFSET
92	1092	Traverse Dn Offset	TRV DN_OFFSET

Note

Any negative logic (Active OFF) command cannot be assigned to the functions marked with "—" in the "Active OFF" column.

The "Enable external alarm trip" and "Force to stop" are fail-safe terminal commands. For example, when data = 9 in "Enable external alarm trip," "Active OFF" (alarm is triggered when OFF); when data = 1009, "Active ON" (alarm is triggered when ON).

Terminal function assignment and data setting

- Select multistep frequency (0 to 15 steps) -- **SS1**, **SS2**, **SS4**, and **SS8**
(Function code data = 0, 1, 2, and 3)

The combination of the ON/OFF states of digital input signals **SS1**, **SS2**, **SS4** and **SS8** selects one of 16 different frequency commands defined beforehand by 15 function codes C05 to C19 (Multistep frequency 0 to 15). With this, the inverter can drive the motor at 16 different preset frequencies.

The table below lists the frequencies that can be obtained by the combination of switching **SS1**, **SS2**, **SS4** and **SS8**. In the "Selected frequency" column, "Other than multistep frequency" represents the reference frequency sourced by frequency command 1 (F01), frequency command 2 (C30), or others.

SS8	SS4	SS2	SS1	Selected frequency
OFF	OFF	OFF	OFF	Other than multistep frequency
OFF	OFF	OFF	ON	C05 (Multistep frequency 1)
OFF	OFF	ON	OFF	C06 (Multistep frequency 2)
OFF	OFF	ON	ON	C07 (Multistep frequency 3)
OFF	ON	OFF	OFF	C08 (Multistep frequency 4)
OFF	ON	OFF	ON	C09 (Multistep frequency 5)
OFF	ON	ON	OFF	C10 (Multistep frequency 6)
OFF	ON	ON	ON	C11 (Multistep frequency 7)
ON	OFF	OFF	OFF	C12 (Multistep frequency 8)
ON	OFF	OFF	ON	C13 (Multistep frequency 9)
ON	OFF	ON	OFF	C14 (Multistep frequency 10)
ON	OFF	ON	ON	C15 (Multistep frequency 11)
ON	ON	OFF	OFF	C16 (Multistep frequency 12)
ON	ON	OFF	ON	C17 (Multistep frequency 13)
ON	ON	ON	OFF	C18 (Multistep frequency 14)
ON	ON	ON	ON	C19 (Multistep frequency 15)

- Select ACC/DEC time -- **RT1** (Function code data = 4)

This terminal command switches between ACC/DEC time 1 (F07, F08) and ACC/DEC time 2 (E10, E11).

If no **RT1** command is assigned, ACC/DEC time 1 (F07, F08) takes effect by default.

Input terminal command RT1	Acceleration/deceleration time
OFF	Acceleration/deceleration time 1 (F07, F08)
ON	Acceleration/deceleration time 2 (E10, E11)

■ Enable 3-wire operation -- **HLD** (Function code data = 6)

Turning this terminal command ON self-holds the forward **FWD** or reverse **REV** run command issued with it, to enable 3-wire inverter operation.

Short-circuiting the terminals between **HLD** and [CM] (i.e., when **HLD** is ON) self-holds the first **FWD** or **REV** command at its leading edge. Turning **HLD** OFF releases the self-holding.

When **HLD** is not assigned, 2-wire operation involving only **FWD** and **REV** takes effect.

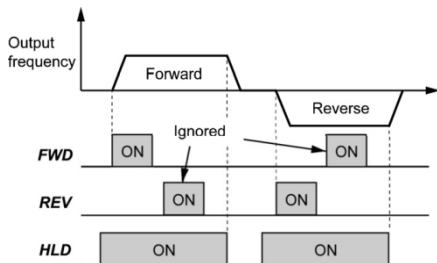

■ Coast to a stop -- **BX** (Function code data = 7)

Turning this terminal command ON immediately shuts down the inverter output so that the motor coasts to a stop without issuing any alarms.

■ Reset alarm -- **RST** (Function code data = 8)

Turning this terminal command ON clears the **ALM** state--alarm output (for any fault). Turning it OFF erases the alarm display and clears the alarm hold state.

When you turn the **RST** command ON, keep it ON for 10 ms or more. This command should be kept OFF for the normal inverter operation.

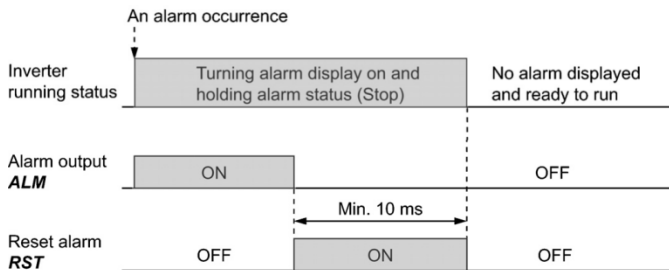

■ Enable external alarm trip -- **THR** (Function code data = 9)

Turning this terminal command OFF immediately shuts down the inverter output (so that the motor coasts to a stop), displays the alarm Oh2, and outputs the alarm relay (for any fault) **ALM**. The **THR** command is self-held, and is reset when an alarm reset takes place.



Use this alarm trip command from external equipment when you have to immediately shut down the inverter output in the event of an abnormal situation in a peripheral equipment.

- Ready for jogging -- **JOG** (Function code data = 10)

This terminal command is used to jog or inch the motor for positioning a work piece.

Turning this command ON makes the inverter ready for jogging.

Simultaneous keying (STOP) + (RUN) keys on the keypad is functionally equivalent to this command; however, it is restricted by the run command source as listed below. When

the run command source is the keypad (F02 = 0, 2 or 3):

Input terminal command JOG	(STOP)+(RUN) keys on the keypad	Inverter running state
ON	—	Ready for jogging
OFF	Pressing these keys toggles between the "normal operation" and "ready for jogging."	Normal operation
		Ready for jogging

When the run command source is digital input (F02 = 1):

Input terminal command JOG	(STOP) + (RUN) keys on the keypad	Inverter running state
ON	Disable	Ready for jogging
OFF		Normal operation

Jogging operation

Pressing the (RUN) key or turning the **FWD** or **REV** terminal command ON starts jogging.

For the jogging by the keypad, the inverter jogs only when the (RUN) key is held down. Releasing the (RUN) key decelerates to stop.

During jogging, the frequency specified by C20 (Jogging Frequency) and the acceleration/deceleration time specified by H54 (ACC/DEC Time) apply.



Note

- The inverter's status transition between "ready for jogging" and "normal operation" is possible only when the inverter is stopped.
- To start jogging operation by simultaneously entering the **JOG** terminal command and a run command (e.g., **FWD**), the input delay time between the two commands should be within 100 ms. If a run command **FWD** is entered first, the inverter does not jog the motor but runs it ordinarily until the next input of the **JOG**.

- Select frequency command 2/1 -- **H2/Hz1** (Function code data = 11)

Turning this terminal command ON and OFF switches the frequency command source between frequency command 1 (F01) and frequency command 2 (C30).

If no **H2/Hz1** terminal command is assigned, the frequency sourced by F01 takes effect by default.

Input terminal command H2/Hz1	Frequency command source
OFF	Follow F01 (Frequency command 1)
ON	Follow C30 (Frequency command 2)

- Enable DC braking -- **DCBRK** (Function code data = 13)

This terminal command gives the inverter a DC braking command through the inverter's digital input. (Refer to the descriptions of F20 to F22.)

- UP (Increase output frequency) and DOWN (Decrease output frequency) commands
-- **UP** and **DOWN** (Function code data = 17, 18)

- Frequency setting

When the **UP/DOWN** control is selected for frequency setting with a run command ON, turning the **UP** or **DOWN** terminal command ON causes the output frequency to increase or decrease, respectively, within the range from 0 Hz to the maximum frequency as listed below.

UP	DOWN	Function
Data = 17	Data = 18	
OFF	OFF	Keep the current output frequency.
ON	OFF	Increase the output frequency with the acceleration time currently specified.
OFF	ON	Decrease the output frequency with the deceleration time currently specified.
ON	ON	Keep the current output frequency.

The **UP/DOWN** control is available in two modes--one mode ($H61 = 0$) in which the initial value of the reference frequency is fixed to "0.00" at the start of the **UP/DOWN** control and the other mode ($H61 = 1$) in which the reference frequency applied in the previous **UP/DOWN** control applies as the initial value.

When $H61 = 1$, the reference frequency applied by the previous **UP/DOWN** control has been cleared to "0," so at the next restart (including powering on), use the **UP** terminal command to accelerate the speed as needed.

When $H61 = 1$, the inverter internally holds the current output frequency set by the **UP/DOWN** control and applies the held frequency at the next restart (including powering on).

Note At the time of restart, if an **UP** or **DOWN** terminal command is entered before the internal frequency reaches the output frequency saved in the memory, the inverter saves the current output frequency into the memory and starts the **UP/DOWN** control with the new frequency. The previous frequency held will be overwritten by the current one.

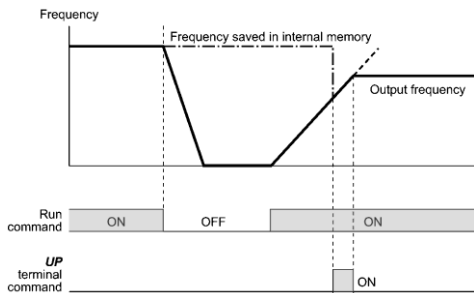

Initial frequency for the **UP/DOWN** control when the frequency command source is switched

When the frequency command source is switched to the **UP/DOWN** control from other sources, the initial frequency for the **UP/DOWN** control is as listed below:

Frequency command source	Switching command	Initial frequency for UP/DOWN control	
		$H61 = 0$	$H61 = 1$
Other than UP/DOWN (F01, C30)	Select frequency command 2/1 (Hz2/Hz1)	Reference frequency given by the frequency command source used just before switching	
PID conditioner	Cancel PID control (Hz/PID)	Reference frequency given by PID control (PID controller output)	
Multistep frequency	Select multistep frequency (SS1, SS2, SS4 and SS8)	Reference frequency given by the frequency command source used just before switching	Reference frequency at the time of previous UP/DOWN control
Communications link	Enable communications link via RS-485 (LE)		

Note To enable the **UP** and **DOWN** terminal commands, you need to set frequency command 1 (F01) or frequency command 2 (C30) to "7" beforehand.

- Enable communications link via RS-485 -- **LE**
(Function code data = 24)

Turning this terminal command ON assigns priorities to frequency commands or run commands received via the RS-485 communications link (H30).

No **LE** assignment is functionally equivalent to the **LE** being ON. (Refer to the description of H30.)

- Run forward -- **FWD** (Function code data = 98)

Turning this terminal command ON runs the motor in the forward direction; turning it OFF decelerates it to stop.

 This terminal command can be assigned only by E98 or E99.

- Run reverse -- **REV** (Function code data = 99)

Turning this terminal command ON runs the motor in the reverse direction; turning it OFF decelerates it to stop.

 This terminal command can be assigned only by E98 or E99.

E20 Terminal [Y1] Function

E27 Terminal [30A/B/C] Function (Relay output)

E20 and E27 assign output signals (listed on the next page) to general-purpose, programmable output terminals [Y1] and [30A/B/C]. These function codes can also switch the logic system between normal and negative to define the property of those output terminals so that the inverter logic can interpret either the ON or OFF status of each terminal as active. The factory default settings are "Active ON."

Terminal [Y1] is a transistor output and terminals [30A/B/C] are relay contact outputs. In normal logic, if an alarm occurs, the relay will be energized so that [30A] and [30C] will be closed, and [30B] and [30C] opened. In negative logic, the relay will be deenergized so that [30A] and [30C] will be opened, and [30B] and [30C] closed. This may be useful for the implementation of failsafe power systems.



Note

- When a negative logic is employed, all output signals are active (e.g. an alarm would be recognized) while the inverter is powered OFF. To avoid causing system malfunctions by this, interlock these signals to keep them ON using an external power supply. Furthermore, the validity of these output signals is not guaranteed for approximately 1.5 seconds after power-on, so introduce such a mechanism that masks them during the transient period.
- Terminals [30A/B/C] use mechanical contacts that cannot stand frequent ON/OFF switching. Where frequent ON/OFF switching is anticipated (for example, limiting a current by using signals subjected to inverter output limit control such as switching to commercial power line), use transistor output [Y1] instead. The service life of a relay is approximately 200,000 times if it is switched ON and OFF at one-second intervals.

The table below lists functions that can be assigned to terminals [Y1] and [30A/B/C].

To make the explanations simpler, the examples shown below are all written for the normal logic (Active ON).

Function code data		Functions assigned	Symbol
Active ON	Active OFF		
0	1000	Inverter running	<i>RUN</i>
1	1001	Frequency arrival signal	<i>FAR</i>
2	1002	Frequency detected	<i>FDT</i>
3	1003	Under voltage detected (Inverter stopped)	<i>LU</i>
5	1005	Inverter output limiting	<i>IOL</i>
6	1006	Auto-restarting after momentary power failure	<i>IPF</i>
7	1007	Motor overload early warning	<i>OL</i>
26	1026	Auto-resetting	<i>TRY</i>
30	1030	Service lifetime alarm	<i>LIFE</i>
35	1035	Inverter running 2	<i>RUN2</i>
36	1036	Overload prevention control	<i>OLP</i>
37	1037	Current detected	<i>ID</i>
38	1038	Current detected 2	<i>ID2</i>
41	1041	Low current detected	<i>IDL</i>
43	1043	Under PID control	<i>PID-CTL</i>
44	1044	Motor stopped due to slow flowrate under PID control	<i>PID-STP</i>
56	1056	Motor overheat detected by thermistor (PTC)	<i>THM</i>
57	1057	Brake signal	<i>BRKS</i>
59	1059	Terminal [C1] wire break	<i>C1OFF</i>
84	1084	Maintenance timer	<i>MNT</i>
87	1087	Frequency arrival detected	<i>FARFDT</i>
90	1090	Traverse Up	<i>TRV_UP</i>
91	1091	Traverse Out	<i>TRV_OUT</i>
99	1099	Alarm output (for any alarm)	<i>ALM</i>

■ Inverter running -- ***RUN*** (Function code data = 0)

This output signal tells the external equipment that the inverter is running at a starting frequency or higher. It comes ON when the output frequency exceeds the starting frequency, and it goes OFF when it is less than the stop frequency. It is also OFF when the DC braking is in operation.

If this signal is assigned in negative logic (Active OFF), it can be used as a signal indicating "Inverter being stopped."

■ Frequency arrival signal -- ***FAR*** (Function code data = 1)

This output signal comes ON when the difference between the output frequency and reference frequency comes within the frequency arrival hysteresis width specified by E30. (Refer to the description of E30.)

■ Frequency detected -- **FDT** (Function code data = 2)

This output signal comes ON when the output frequency exceeds the frequency detection level specified by E31, and it goes OFF when the output frequency drops below the "Frequency detection level (E31) - Hysteresis width (E32)."

■ Under voltage detected -- **LU** (Function code data = 3)

This output signal comes ON when the DC link bus voltage of the inverter drops below the specified under voltage level, and it goes OFF when the voltage exceeds the level.

This signal is ON also when the under voltage protective function is activated so that the motor is in an abnormal stop state (e.g., tripped).

When this signal is ON, a run command is disabled if given.

■ Inverter output limiting -- **IOL** (Function code data = 5)

This output signal comes ON when the inverter is limiting the output frequency by activating any of the following actions (minimum width of the output signal: 100 ms).

- Current limiting by software (F43 and F44)
- Instantaneous overcurrent limiting by hardware (H12 = 1)
- Automatic deceleration (Anti-regenerative control) (H69 = 2 or 4)



When the **IOL** signal is ON, the output frequency may have deviated from the specified frequency because of the limiting function above.

■ Auto-restarting after momentary power failure -- **IPF** (Function code data = 6)

This output signal is ON either during continuous running after a momentary power failure or during the period from when the inverter has detected an under voltage condition and shut down the output until restart has been completed (the output has reached the reference frequency).

To enable this **IPF** signal, set F14 (Restart mode after momentary power failure) to "4" (Enable restart (Restart at the frequency at which the power failure occurred)) or "5" (Enable restart (Restart at the starting frequency)) beforehand.

■ Motor overload early warning -- **OL** (Function code data = 7)

This output signal is used to issue a motor overload early warning that enables you to take a corrective action before the inverter detects a motor overload alarm O11 and shuts down its output. (Refer to the description of E34.)



For details about the judgment on service life, refer to Table 7.3 "Criteria for Issuing a Lifetime Alarm" in Chapter 7, Section 7.3 "List of Periodical Replacement Parts."

- Inverter running 2 -- **RUN2** (Function code data = 35)

This signal acts in the same way as **RUN** (Function code data = 0) except that **RUN2** is ON even when the DC braking is in operation.

- Overload prevention control -- **OLP** (Function code data = 36)

This output signal comes ON when the overload prevention control is activated. The minimum ON-duration is 100 ms. (Refer to the description of H70.)

- Current detected and Current detected 2 -- **ID** and **ID2** (Function code data = 37, 38)

The **ID** or **ID2** output signal comes ON when the output current of the inverter exceeds the level specified by E34 (Current detection (Level)) or E37 (Current detection 2 (Level)) for the time longer than the one specified by E35 (Current detection (Timer)) or E38 (Current detection 2 (Timer)), respectively. The minimum ON-duration is 100 ms.

The **ID** or **ID2** goes OFF when the output current drops below 90% of the rated operation level.

These two output signals can be assigned to two different digital output terminals independently if necessary.



Note Function code E34 is effective for not only the motor overload early warning **OL**, but also for the operation level of the current detection **ID**. (Refer to the description of E34.)

- Low current detected -- **IDL** (Function code data = 41)

This output signal comes ON when the inverter output current drops below the low current detection level (E34) and it remains at the low level for the timer period (E35). When the output current exceeds the current detection level (E37) by 5% or more of the inverter rated current, this signal goes OFF. The minimum ON-duration is 100 ms. (Refer to the description of E34.)

- Under PID control -- **PID-CTL** (Function code data = 43)

This output signal comes ON when PID control is enabled ("Cancel PID control" (**Hz/PID**) = OFF) and a run command is ON. (Refer to the description of J01.)

- Motor stopped due to slow flowrate under PID control -- **PID-STP** (Function code data = 44) This output signal comes ON when the inverter is stopped by the slow flowrate stop function under PID control. (Refer to the descriptions of J15 through J17.)



Note When PID control is enabled, the inverter may stop due to the slow flowrate stop function or other reasons, with the **PID-CTL** signal being ON. As long as the **PID-CTL** signal is ON, PID control is effective, so the inverter may abruptly resume its operation, depending on the PID feedback value.

WARNING

When PID control is enabled, even if the inverter stops its output during operation because of sensor signals or other reasons, operation will resume automatically.

Design your machinery so that safety is ensured even in such cases.

Otherwise, an accident could occur.

- Motor overheat detected by thermistor (PTC) -- **THM** (Function code data = 56)

When the thermistor is enabled (H26 = 2), this output signal comes ON if the motor temperature rises to the protection trigger level specified by H27.

- Brake signal -- **BRKS** (Function code data = 57)

This signal outputs a brake control command that releases or activates the brake.

- Terminal [C1] wire break -- **C1OFF** (Function code data = 59)

When terminal [C1] is used for a feedback signal under PID control, this output signal comes ON if the [C1] wire breaks, thereby enabling it to activate the protection function.

- Frequency arrival detected -- **FARFDT** (Function code data = 87)

The **FARFDT**, which is an ANDed signal of **FAR** and **FDT**, comes ON when both signal conditions are met.

- Alarm output (for any alarm) -- **ALM** (Function code data = 99)

This output signal comes ON if any of the protective functions is activated and the inverter enters Alarm mode.

E30 Frequency Arrival (Hysteresis width for **FAR**)

E30 specifies the detection level (hysteresis width) for **FAR** ("Frequency arrival signal").

The moment the output frequency reaches the zone defined by "Reference frequency ± Hysteresis width specified by E30," the **FAR** comes ON.

The operation timings of signals are shown in the graph below.

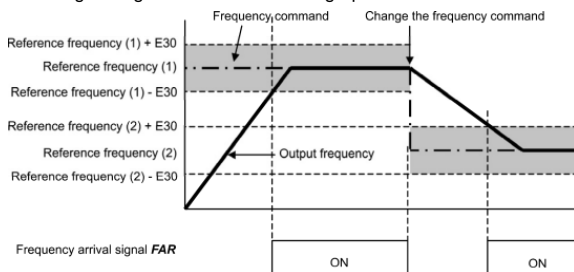

E34, E35 Overload Early Warning/Low Current Detection (Level and Timer)

E37, E38 Current Detection 2 (Level and Timer)

These function codes define the detection level and timer for the **OL** ("Motor overload early warning"), **ID** ("Current detected"), **ID2** ("Current detected 2") and **IDL** ("Low current detected") output signals.

Output signal	Data assigned to output terminal	Detection level Range: See below	Timer Range: 0.01 to 600.00 s	Motor characteristics Range: See below	Thermal time constant Range: 0.5 to 75.0 min
OL	7	E34	--	F10	F12
ID	37	E34	E35	--	--
ID2	38	E37	E38		
IDL	41	E34	E35		

- Data setting range

Operation level: 0.00 (Disable), 1 to 200% of inverter rated current

Motor characteristics 1: Enable (For a general-purpose motor and standard permanent magnet synchronous motor with shaft-driven cooling fan)

2: Enable (For an inverter-driven motor with separately powered cooling fan)

■ Motor overload early warning signal -- **OL**

The **OL** signal is used to detect a symptom of an overload condition (alarm code **O11**) of the motor so that the user can take an appropriate action before the alarm actually happens.

The **OL** signal turns ON when the inverter output current has exceeded the level specified by E34. In typical cases, set E34 data to 80 to 90% against F11 data (Electronic thermal overload protection for motor 1, Overload detection level). Specify also the thermal characteristics of the motor with F10 (Select motor characteristics) and F12 (Thermal time constant). To utilize this feature, you need to assign **OL** (data = 7) to any of the digital output terminals.

■ Current detected and Current detected 2 signals -- **ID** and **ID2**

When the inverter output current has exceeded the level specified by E34 or E37 and it continues longer than the period specified by E35 or E38, the **ID** or **ID2** signal turns ON, respectively. When the output current drops below 90% of the rated operation level, the **ID** or **ID2** turns OFF. (Minimum width of the output signal: 100 ms)

To utilize this feature, you need to assign **ID** (data = 37) or **ID2** (data = 38) to any of digital output terminals.

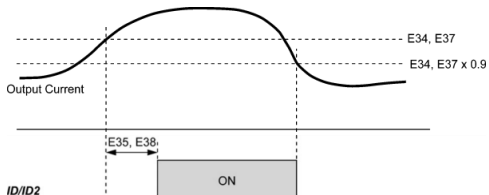

■ Low current detected -- *IDL*

This signal turns ON when the output current drops below the low current detection level (E34) and remains at the low level for the timer period (E35). When the output current exceeds the "Low current detection level plus 5% of the inverter rated current," it goes OFF. (The minimum ON-duration is 100 ms.)

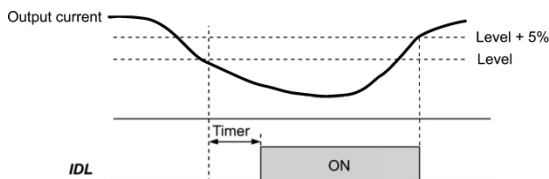

E39 Coefficient for Constant Feeding Rate Time

E50 Coefficient for Speed Indication

E39 and E50 specify coefficients for determining the constant feeding rate time, load shaft speed, and line speed, as well as for displaying the output status monitored.

Calculation expression

Coefficient for speed indication (E50)

$$\text{Constant feeding rate time (min)} = \frac{\text{Coefficient for speed indication (E50)}}{\text{Frequency} \times \text{Coefficient for constant feeding rate time (E39)}}$$

Load shaft speed = Coefficient for speed indication (E50) × Frequency (Hz)

Line speed = Coefficient for speed indication (E50) × Frequency (Hz)

Where, the "frequency" refers to the "reference frequency" to be applied for settings (constant feeding rate time, load shaft speed, or line speed), or to the "output frequency before slip compensation" to be applied for monitor.

If the constant feeding rate time is 999.9 min. or more or the denominator of the right-hand side is zero (0), "999.9" appears.

E52 Keypad (Menu display mode)

E52 provides a choice of three menu display modes for the keypad as listed below.

Data for E52	Menu display mode	Menus to be displayed
0	Function code data editing mode	Menu #1
1	Function code data check mode	Menu #2
2	Full-menu mode	Menus #1 through #6 *

* Menus #1 through #7 when a remote keypad is connected.



Selecting the full-menu mode (E52 = 2) allows you to cycle through the menus with the \uparrow or \downarrow key and select the desired menu item with the ENTER key. Once the entire menu has been cycled through, the display returns to the first menu item.

E60	Built-in Potentiometer (Function selection)
E61	Terminal [12] Extended Function
E62	Terminal [C1] Extended Function

E60 through E62 define the property of the built-in potentiometer and terminals [12] and [C1], respectively.

There is no need to set up the potentiometer and terminals if they are to be used for frequency command sources.



Data for E60, E61, or E62	Function	Description
0	None	--
1	Auxiliary frequency command 1	This is an auxiliary analog frequency input to be added to frequency command 1 (F01). It is never added to frequency command 2, multistep frequency command or other frequency commands.
2	Auxiliary frequency command 2	This is an auxiliary analog frequency input to be added to all frequency commands including frequency command 1, frequency command 2 and multistep frequency commands.
3	PID command 1	This input includes temperature, pressure or other commands to apply under the PID control. Function code J02 should be also configured.
5	PID feedback amount	This input includes the feedback of the temperature or pressure under the PID control. (Not available for E60.)

Note If the built-in potentiometer and different terminals have been set up to have the same data, the operation priority is given in the following order:



E60 > E61 > E62

Selecting the **UP/DOWN** control (F01, C30 = 7) ignores auxiliary frequency command 1 and 2.

C21 Timer Operation

C21 enables or disables a timer operation that is triggered by a run command and continues for the timer count previously specified with the   keys. The operating procedure for the timer operation is given below.

Data for C21	Function
0	Disable timer operation
1	Enable timer operation



- Tip**
- Pressing the  key during timer countdown quits the timer operation.
 - Even if C21 = 1, setting the timer to 0 no longer starts the timer operation with the  key.
 - Applying terminal command **FWD** or **REV** instead of the key command can also start the timer operation.

Operating procedure for timer operation (example)

Preparation

- To display the timer count on the LED monitor, set E43 (LED Monitor) to "13" (Timer) and set C21 (Timer Operation) to "1" (Enable).
- Specify the reference frequency to apply to timer operation. When the keypad is selected as a frequency command source, press the  key to shift to the speed monitor and specify the desired reference frequency.

Triggering the timer operation with the key

- (1) While watching the timer count displayed on the LED monitor, press the  key to set the timer for the desired count in seconds. Note that the timer count on the LED monitor appears as an integral number without a decimal point.
- (2) Press the  key. The motor starts running and the timer starts counting down. If the timer counts down, the motor stops without pressing the  key. (Even if the LED monitor displays any item except the timer count, the timer operation is possible.)



Note

After the countdown of the timer operation triggered by a terminal command such as **FWD**, the inverter decelerates to stop and at that moment the LED monitor displays **end** and any LED monitor item (0 for the timer count) alternately. Turning **FWD** OFF returns to the LED monitor item.

C33 Analog Input Adjustment for Terminal [12] (Filter time constant)

C38 Analog Input Adjustment for Terminal [C1] (Filter time constant)

C33 and C38 configure a filter time constant for an analog voltage and current input on terminals [12] and [C1], respectively.

The larger the time constant, the slower the response. Specify the proper filter time constant taking into account the response speed of the machine (load). If the input voltage fluctuates due to line noise, remove the cause of the noise or take an electric circuit related measure. Only when no effect is obtained, increase the time constant.

P02 Motor 1 (Rated capacity)

P02 specifies the rated capacity of the motor. Enter the rated value given on the nameplate of the motor.

Data for P02	Unit	Remarks
0.01 to 30.00	kW	When P99 = 0

P03 Motor 1 (Rated current)

P03 specifies the rated current of the motor. Enter the rated value given on the nameplate of the motor.

P04 Motor 1 (Auto-tuning)

The inverter automatically detects the motor parameters and saves them in its internal memory. Basically, it is not necessary to perform tuning when using a standard motor with a standard connection with the inverter.

In any of the following cases, perform auto-tuning since the motor parameters are different from those of standard motors so as not to obtain the best performance under each of these controls-- auto torque boost, torque calculation monitoring, auto energy saving operation, automatic deceleration (anti-regenerative control), slip compensation, and torque vector control.

- The motor to be driven is made by other manufacturer or is a non-standard motor.
- Cabling between the motor and the inverter is long.
- A reactor is inserted between the motor and the inverter.

 For details of auto-tuning, refer to Chapter 4, Section 4.1.3 "Preparation before a test run--Configuring function code data."

P06,P07

P08,P12 Motor 1 (No-load current, %R1, %X and Motor 1, Rated slip frequency)

P06 through P08 and P12 specify no-load current, %R1, %X, and rated slip frequency, respectively. Obtain the appropriate values from the test report of the motor or by calling the manufacturer of the motor.

Performing auto-tuning automatically sets these parameters.

- No-load current (P06): Enter the value obtained from the motor manufacturer.
- %R1 (P07): Enter the value calculated by the following expression.

$$\%R1 = \frac{R1 + \text{Cable } R1}{V / (\sqrt{3} \times I)}$$

where,

R1: Primary resistance of the motor (Ω)

Cable R1: Resistance of the output cable (Ω)

V: Rated voltage of the motor (V)

I: Rated current of the motor (A)

- %X (P08): Enter the value calculated by the following expression

$$\%R1 = \frac{X1 + X2 + XM / (X2 + XM) + \text{Cable } X}{V / (\sqrt{3} \times I)} \times 100 (\%)$$

where

X1: Primary leakage reactance of the motor (Ω)

X2: Secondary leakage reactance of the motor (converted to primary) (Ω)

XM: Exciting reactance of the motor (Ω)

Cable X: Reactance of the output cable (Ω)

V: Rated voltage of the motor (V)

I: Rated current of the motor (A)

■ Rated slip frequency (P12)

Convert the value obtained from the motor manufacturer to Hz using the following expression and enter the converted value. (Note: The motor rating given on the nameplate sometimes shows a larger value.)

$$\text{Rated slip frequency (Hz)} = \frac{-(\text{Synchronous speed} - \text{Rated speed})}{\text{Synchronous speed}} \times \text{Base frequency}$$



For reactance, choose the value at the base frequency 1 (F04).





P09	Motor 1 (Slip compensation gain for driving)
P10	(Slip compensation response time)
P11	(Slip compensation gain for braking)

P09 and P11 determine the slip compensation amount in % for driving and braking individually. Specification of 100% fully compensates for the rated slip of the motor. Excessive compensation (P09, P11 > 100%) may cause a system oscillation, so carefully check the operation on the actual machine.

P10 determines the response time for slip compensation. Basically, there is no need to modify the default setting. If you need to modify it, consult your ADT Co., Ltd representatives.

H03 Data Initialization

H03 initializes the current function code data to the factory defaults or initializes the motor parameters.

To change the H03 data, it is necessary to press the  +  keys or  +  keys (simultaneous keying).

Data for H03	Function
0	Disable initialization (Settings manually made by the user will be retained.)
1	Initialize all function code data to the factory defaults
2	Initialize motor 1 parameters in accordance with P02 (Rated capacity) and P99 (Motor 1 selection) Function codes subject to initialization: P03, P06 to P12 and constants for internal control (These function codes will be initialized to the values listed in tables on the following pages.)

- To initialize the motor parameters, set the related function codes using the following steps.
 - 1) P02 Set the rated capacity of the motor to be used in kW.
Motor (Rated capacity)
 - 2) P99 Select the characteristics of the motor
Motor Selection
 - 3) H03 Data Initialization Initialize the motor parameters. (H03 = 2)
 - 4) P03 Set the rated current on the nameplate if the already set data
Motor (Rated current) differs from the rated current printed on the nameplate of the motor.
- Upon completion of the initialization, the H03 data reverts to "0" (factory default).
- If the P02 data is set to a value other than the nominal applied motor rating, data initialization with H03 internally converts the specified value forcedly to the equivalent nominal applied motor rating (see the tables on the next page).

H04 and H05 specify the auto-reset function that makes the inverter automatically attempt to reset the tripped state and restart without issuing an alarm (for any faults) even if any protective function subject to reset is activated and the inverter enters the forced-to-stop state (tripped state).

If the protective function works in excess of the times specified by H04, the inverter will issue an alarm (for any faults) and not attempt to auto-reset the tripped state.

Listed below are the recoverable alarm statuses to be retried.

Alarm status	LED monitor displays:	Alarm status	LED monitor displays:
Overcurrent protection	OC1, OC2 or OC3	Motor overheated	OH4
Over voltage protection	OU1, OU2 or OU3	Motor overloaded	OL1
Heat sink overheated	OH1	Inverter overloaded	OLU
Braking resistor overheated	dbH		

■ Number of reset times (H04)

H04 specifies the number of reset times for the inverter to automatically attempt to escape from the tripped state. When H04 = 0, the auto-reset function will not be activated.

⚠ WARNING

If the "auto-reset" function has been specified, the inverter may automatically restart and run the motor stopped due to a trip fault, depending on the cause of the tripping. Design the machinery so that human body and peripheral equipment safety is ensured even when the auto-resetting succeeds.

Otherwise an accident could occur.

■ Reset interval (H05)

After the reset interval specified by H05 from when the inverter enters the tripped state, it issues a reset command to auto-reset the tripped state. Refer to the timing scheme diagram below.

<Timing scheme for failed retry (No. of reset times: 3)>

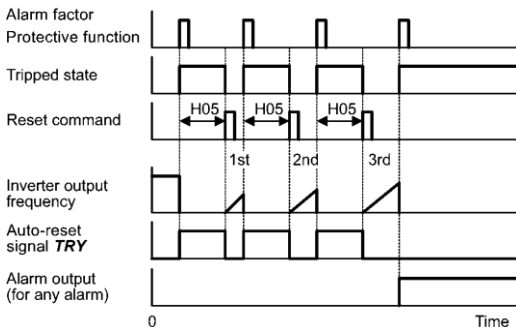

The auto-reset operation can be monitored from the external equipment by assigning the digital output signal TRY to any of the programmable output terminals [Y1] and [30A/B/C] with E20 or E27 (data = 26).

H06 Cooling Fan ON/OFF Control

To prolong the life of the cooling fan and reduce fan noise during running, the cooling fan stops when the temperature inside the inverter drops below a certain level while the inverter stops. However, since frequent switching of the cooling fan shortens its life, the cooling fan is kept running for 10 minutes once it is started.

H06 specifies whether to keep running the cooling fan all the time or to control its ON/OFF.

Data for H06	Cooling fan ON/OFF
0	Disable (Cooling fan always ON)
1	Enable (ON/OFF control effective)

H07 Acceleration/Deceleration Pattern

H07 specifies the acceleration and deceleration patterns (patterns to control output frequency).

Linear acceleration/deceleration

The inverter runs the motor with the constant acceleration and deceleration.

S-curve acceleration/deceleration

To reduce an impact that acceleration/deceleration would make on the machine (load), the inverter gradually accelerates or decelerates the motor in both starting and ending zones of acceleration/deceleration. Two types of S-curve acceleration/deceleration rates are available; 5% (weak) and 10% (strong) of the maximum frequency, which are shared by the four inflection points.

The acceleration/deceleration time command determines the duration of acceleration/deceleration in the linear period; hence, the actual acceleration/deceleration time is longer than the reference acceleration/deceleration time.

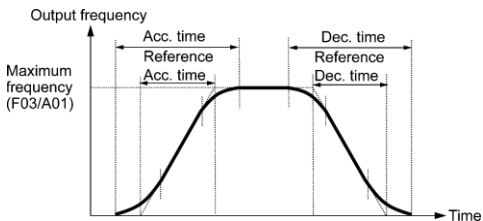

Acceleration/deceleration time

<S-curve acceleration/deceleration (weak): when the frequency change is 10% or more of the maximum frequency>

$$\begin{aligned}\text{Acceleration or deceleration time (s)} &= (2 \times 5/100 + 90/100 + 2 \times 5/100) \times (\text{reference} \\ &\quad \text{acceleration or deceleration time}) \\ &= 1.1 \times (\text{reference acceleration or deceleration time})\end{aligned}$$

<S-curve acceleration/deceleration (strong): when the frequency change is 20% or more of the maximum frequency>

$$\begin{aligned}\text{Acceleration or deceleration time (s)} &= (2 \times 10/100 + 80/100 + 2 \times 10/100) \times (\text{reference} \\ &\quad \text{acceleration or deceleration time}) \\ &= 1.2 \times (\text{reference acceleration or deceleration time})\end{aligned}$$

H11 Deceleration Mode

H11 specifies the deceleration mode to be applied when a run command is turned OFF.

Data for H11	Function
0	Normal deceleration The inverter decelerates and stops the motor according to deceleration commands specified by H07 (Acceleration/deceleration pattern), F08 (Deceleration time 1), and E11 (Deceleration time 2).
1	Coast-to-stop The inverter immediately shuts down its output, so the motor stops according to the inertia of the motor and machine and their kinetic energy losses.



Note

When reducing the reference frequency, the inverter decelerates the motor according to the deceleration commands even if H11 = 1 (Coast-to-stop).

H12 Instantaneous Overcurrent Limiting (Mode selection)

H12 specifies whether the inverter invokes the current limit processing or enters the overcurrent trip when its output current exceeds the instantaneous overcurrent limiting level. Under the current limit processing, the inverter immediately turns OFF its output gate to suppress the further current increase and continues to control the output frequency.

Data for H12	Function
0	Disable An overcurrent trip occurs at the instantaneous overcurrent limiting level.
1	Enable The current limiting operation is effective.

If any problem occurs when the motor torque temporarily drops during current limiting processing, it is necessary to cause an overcurrent trip (H12 = 0) and actuate a mechanical brake at the same time.

Note The similar function is the current limiter specified by F43 and F44. The current limiter (F43, F44) implements the current control by software, so an operation delay occurs. When you have enabled the current limiter (F43, F44), also enable the instantaneous overcurrent limiting with H12 to obtain a quick response current limiting.

Depending on the load, extremely short acceleration time may activate the current limiting to suppress the increase of the inverter output frequency, causing hunting (undesirable oscillation of the system) or activating the inverter overvoltage trip. When specifying the acceleration time, therefore, you need to take into account machinery characteristics and moment of inertia of the load.

CAUTION

When the instantaneous overcurrent limiting is enabled, the motor output torque could drop. For driving elevating machinery which could cause a serious problem with a drop of the motor output torque, therefore, disable the instantaneous overcurrent limiting. Note that disabling it will cause an overcurrent trip when a current exceeding the inverter protection level flows, so secure the protective coordination using a mechanical brake.

An accident could occur.

H45	Mock Alarm
H97	Clear Alarm Data

H45 causes the inverter to generate a mock alarm in order to check whether external sequences function correctly at the time of machine setup.

Setting the H45 data to "1" displays mock alarm **err** on the LED monitor. It also issues alarm output **ALM** (if assigned to a digital output terminal specified by E20 or E27). (Accessing the H45 data requires simultaneous keying of "STOP key +  key.") After that, the H45 data automatically reverts to "0," allowing you to reset the alarm.

Just as for data (alarm history and relevant information) of those alarms that could occur in running the inverter, the inverter saves mock alarm data, enabling you to confirm the mock alarm status.

To clear the mock alarm data, use H97. (Accessing the H97 data requires simultaneous keying of "STOP key +  key.") H97 data automatically reverts to "0" after clearing the alarm data.

H69	Automatic Deceleration (Anti-regenerative control) (Mode selection)
H76	Automatic Deceleration (Frequency increment limit for braking)

H69 specifies the anti-regenerative control.

In inverters not equipped with a PWM converter or braking resistor, if regenerative energy returned exceeds the inverter's braking capability, an overvoltage trip occurs.

When H69 = 1: The anti-regenerative control is functionally equivalent to that of the original iMaster-U1. That is, when the DC link bus voltage exceeds the preset voltage limiting level, the inverter lengthens the deceleration time to three times the specified time to decrease the deceleration torque to 1/3. In this way, the inverter reduces the regenerative energy tentatively. This control applies only in deceleration. When the load on the motor results in a braking effect, the control does not have any effect.

When H69 = 2 or 4: The inverter controls the output frequency to keep the braking torque at around 0 N·m in both acceleration/deceleration and constant speed running phases in order to avoid an overvoltage trip.

Since increasing the output frequency too much under anti-regenerative control is dangerous, the inverter has a torque limiter (Frequency increment limit for braking) that can be specified by H76. The torque limiter limits the inverter's output frequency to less than "Reference frequency + H76 setting."

Note that the torque limiter activated restrains the anti-regenerative control, resulting in a trip with an overvoltage alarm in some cases. Increasing the H76 data (0.0 to 400.0 Hz) makes the anti-regenerative control capability high.

In addition, during deceleration triggered by turning the run command OFF, the anti-regenerative control increases the output frequency so that the inverter may not stop the load depending on the load state (huge moment of inertia, for example). To avoid that, H69 provides a choice of cancellation of the anti-regenerative control to apply when three times the specified deceleration time is elapsed, thus decelerating the motor.

Data for H69	Function
0	Disable
1	Enable (Lengthen the deceleration time to three times the specified time under voltage limiting control.)
4	Enable (Torque limit control: Disable force-to-stop processing.)



Note Enabling the anti-regenerative control may automatically increase the deceleration time.

When a braking resistor is connected, disable the anti-regenerative control.

H70 Automatic Overload Prevention Control

H70 specifies the decelerating rate of the output frequency to prevent a trip from occurring due to an overload. This control decreases the output frequency of the inverter before the inverter trips due to a heat sink overheat or inverter overload (with an alarm indication of OH1 or OLU , respectively). It is useful for equipment such as pumps where a decrease in the output frequency leads to a decrease in the load and it is necessary to keep the motor running even when the output frequency drops.

Data for H70	Function
0.00	Decelerate the motor by deceleration time 1 (F08) or 2 (E11)
0.01 to 100.00	Decelerate the motor by deceleration rate from 0.01 to 100.00 (Hz/s)
999	Disable overload prevention control



Note In equipment where a decrease in the output frequency does not lead to a decrease in the load, the overload prevention control is of no use and should not be enabled.

H71 Deceleration Characteristics

Setting the H71 data to "1" (ON) enables forced brake control. If regenerative energy produced during deceleration of the motor and returned to the inverter exceeds the inverter's braking capability, an overvoltage trip will occur. The forced brake control increases the motor energy loss during deceleration, increasing the deceleration torque.



Note This function is aimed at controlling the torque during deceleration; it has no effect if there is braking load.

Enabling the automatic deceleration (anti-regenerative control, H69 = 2 or 4) disables the deceleration characteristics specified by H71.

H94 Cumulative Run Time of Motor 1

Operating the keypad can display the cumulative run time of motor 1. This feature is useful for management and maintenance of the machinery. Using H94 can modify the cumulative run time of the motor to the desired value to be used as an arbitrary initial data. Specifying "0" clears the cumulative run time.

H98 Protection/Maintenance Function (Mode selection)

H98 specifies whether to enable or disable (a) automatic lowering of carrier frequency, (b) input phase loss protection, (c) output phase loss protection in a combination of Bit 0 to Bit 4.

Automatic lowering of carrier frequency (Bit 0)

This function should be used for important machinery that requires keeping the inverter running.

Even if a heat sink overheat or overload occurs due to excessive load, abnormal ambient temperature, or cooling system failure, enabling this function lowers the carrier frequency to avoid tripping (OH1 or OLU). Note that enabling this function results in increased motor noise.

Input phase loss protection (Lin) (Bit 1)

Upon detection of an excessive stress inflicted on the apparatus connected to the main circuit due to phase loss or line-to-line voltage unbalance in the three-phase power supplied to the inverter, this feature stops the inverter and displays an alarm Lin .



In configurations where only a light load is driven or a DC reactor is connected, phase loss or line-to-line voltage unbalance may not be detected because of the relatively small stress on the apparatus connected to the main circuit.

Output phase loss protection (OPL) (Bit 2)

Upon detection of phase loss in the output while the inverter is running, this feature stops the inverter and displays an alarm OPL. Where a magnetic contactor is installed in the inverter output circuit, if the magnetic contactor goes OFF during operation, all the phases will be lost. In such a case, this protection feature does not work.

Chapter 6 TROUBLESHOOTING

6.1 If an Alarm Code Appears on the LED Monitor

Quick reference table of alarm codes

Alarm code	Name	Alarm code	Name
OC1	Instantaneous overcurrent	dbH	Braking resistor overheated
OC2		OL1 OL2	Motor 1 overload Motor 2 overload
OC3		OLU	Inverter overload
OU1	Overvoltage	Er1	Memory error
OU2		Er2	Keypad communications error
OU3		Er3	CPU error
LU	Under voltage	Er6	Operation protection
Lin	Input phase loss	Er7	Tuning error
OPL	Output phase loss	Er8	RS-485 communications error
OH1	Heat sink overheat	ErF	Data saving error during under voltage
OH2	External alarm	Err	Mock alarm
OH4	Motor protection (PTC thermistor)	CoF	PID feedback wire break

6.2 If an Abnormal Pattern Appears on the LED Monitor while No Alarm Code is Displayed

[1] ---- (center bar) appears

Problem A center bar (----) has appeared on the LED monitor.

Possible Causes	What to Check and Suggested Measures
(1) When the PID command and its feedback amount are selected as a monitor item, the PID control is disabled.	To view other monitor items: Check if E43 = 10 (PID command) or 12 (PID feedback amount). Set E43 to a value other than "10" or "12." To view a PID command or its feedback amount: Check if the PID control is disabled (J01 = 0). Set J01 to "1" (Enable process control, normal operation) or "2" (Enable process control, inverse operation).
(2) When timer operation is disabled (C21 = 0), timer is selected as a monitor item (E43 = 13). When timer operation had been enabled (C21 = 1) and timer had been selected as a monitor item by pressing the  key, you disabled timer operation (C21 = 0).	To view other monitor items: Check if E32 = 13 (Timer). Set E43 to a value other than "13." To view timer (s): Check if C21 = 0 (Disable). Set C21 to "1."

[2] ---- (under bar) appears

Problem Although you pressed the  key or entered a run forward command **FWD** or a run reverse command **REV**, the motor did not start and an under bar (----) appeared on the LED monitor.

Possible Causes	What to Check and Suggested Measures
(1) The DC link bus voltage was low.	Select 5_01 under Menu #5 "Maintenance Information" in Programming mode on the keypad, then check the DC link bus voltage that should be 200 VDC and 400 VDC or below for three-phase 400 V class series. Connect the inverter to a power supply that meets its input specifications.

[3] () appears

Problem Parentheses (()) appeared on the LED monitor during speed monitoring on the keypad.

Possible Causes	What to Check and Suggested Measures
(1) The display data overflows the LED monitor.	Check whether the product of the output frequency and the display coefficient (E50) exceeds 9999. Correct the setting of E50.

Chapter 7 MAINTENANCE AND INSPECTION

Perform daily and periodic inspection to avoid trouble and keep reliable operation of the inverter for a long time. When performing inspections, follow the instructions given in this chapter.

WARNING

- Before proceeding to the maintenance and inspection, turn OFF the power and wait at least five minutes. Make sure that the LED monitor is turned OFF.
Electric shock may occur.
- Maintenance, inspection, and parts replacement should be made only by authorized persons.
- Take off the watch, rings and other metallic objects before starting work.
- Use insulated tools.
- Never modify the inverter.
Electric shock or injuries could occur.

7.1 Daily Inspection

Visually inspect the inverter for operation errors from the outside without removing the covers when the inverter is ON or operating.

- Check that the expected performance (satisfying the standard specifications) is obtained.
- Check that the surrounding environment satisfies the requirements given in Chapter 2, Section 2.1 "Operating Environment."
- Check that the LED monitor on the keypad displays normally.
- Check for abnormal noise, odor, or excessive vibration.
- Check for traces of over heat, discoloration and other defects.

7.2 Periodic Inspection

Perform periodic inspection according to the items listed in Table 7.1. Before performing periodic inspection, be sure to stop the motor, shut down the power to the inverter, and then remove the terminal block covers.

Table 7.1 List of Periodic Inspections

Check part	Check item	How to inspect	Evaluation criteria
Environment	1) Check the ambient temperature, humidity, vibration and atmosphere (dust, gas, oil mist, or water drops). 2) Check that tools or other foreign materials or dangerous objects are not left around the equipment.	1) Check visually or measure using apparatus. 2) Visual inspection	1) The standard specification must be satisfied. 2) No foreign or dangerous objects are left.
Voltage	Check that the input voltages of the main and control circuit are correct.	Measure the voltages using a multimeter or the like.	The standard specifications must be satisfied.

Table 7.1 List of Periodic Inspections (Continued)

Check part	Check item	How to inspect	Evaluation criteria
Keypad	1) Check that the display is clear. 2) Check that there is no missing part in the displayed characters.	1), 2) Visual inspection	1), 2) The display can be read and there is no fault.
Structure such as frames and covers	Check for: 1) Abnormal noise or excessive vibration 2) Loose bolts (at clamp sections) 3) Deformation or breakage 4) Discoloration caused by overheat 5) Contamination or accumulation of dust or dirt	1) Visual or auditory inspection 2) Retighten. 3), 4), 5) Visual inspection	1), 2), 3), 4), 5) No abnormalities
Main circuit	Common	1) Retighten. 2), 3) Visual inspection	1), 2), 3) No abnormalities
	Conductors and wires	1), 2) Visual inspection	1), 2) No abnormalities
	Terminal blocks	Visual inspection	No abnormalities
	DC link bus capacitor	1), 2) Visual inspection 3) Measure the discharge time with capacitance probe.	1), 2) No abnormalities 3) The discharge time should not be shorter than the one specified by the replacement manual.
	Braking resistor	1) Olfactory and visual inspection 2) Check the wires visually. Or disconnect either wire and measure the conductivity with a multimeter.	1) No abnormalities 2) Within $\pm 10\%$ of the resistance of the braking resistor
	Transformer and reactor	Check for abnormal roaring noise and odor.	Auditory, visual and olfactory inspection

Table 7.1 List of Periodic Inspections (Continued)

Check part		Check item	How to inspect	Evaluation criteria
Main circuit	Magnetic contactor and relay	1) Check for chatters during operation. 2) Check for rough contacts.	1) Hearing inspection 2) Visual inspection	1), 2) No abnormalities
Control circuit	Printed circuit boards	1) Check for loose screws and connectors. 2) Check for abnormal odor and discoloration. 3) Check for cracks, breakage, deformation and remarkable rust. 4) Check the capacitors for electrolyte leaks and deformation.	1) Retighten. 2) Olfactory and visual inspection 3), 4) Visual inspection	1), 2), 3), 4) No abnormalities
Cooling system	Cooling fan	1) Check for abnormal noise and excessive vibration. 2) Check for loose bolts. 3) Check for discoloration caused by overheat.	1) Auditory and visual inspection, or turn manually (be sure to turn the power OFF). 2) Retighten. 3) Visual inspection	1) Smooth rotation 2), 3) No abnormalities
	Ventilation path	Check the heat sink, intake and exhaust ports for clogging and foreign materials.	Visual inspection	No abnormalities

Remove dust accumulating on the inverter with a vacuum cleaner. If the inverter is stained, wipe it off with a chemically neutral cloth.

7.3 List of Periodical Replacement Parts

The inverter consists of many electronic parts including semiconductor devices. Table 7.2 lists replacement parts that should be periodically replaced for preventive maintenance (Use the lifetime judgment function as a guide). These parts are likely to deteriorate with age due to their constitution and properties, leading to the decreased performance or failure of the inverter.

When the replacement is necessary, consult your ADT Co., Ltd. representative.

Table 7.2 Replacement Parts

Part name	Standard replacement intervals (See Note below.)
DC link bus capacitor	10 years
Electrolytic capacitors on the printed circuit boards	10 years
Cooling fan	10 years

(Note) These replacement intervals are based on the inverter's service life estimated under the following conditions.

- Ambient temperature: 40°C
- Load factor: 80% of the rated current given in parentheses () in Chapter 8 *Specifications
- Running 12 hours/day

In environments with an ambient temperature above 40°C or a large amount of dust or dirt, the replacement intervals may be shorter.

Standard replacement intervals mentioned above are only a guide for replacement, not a guaranteed service life.

7.4 Inquiries about Product and Guarantee

7.4.1 When making an inquiry

Upon breakage of the product, uncertainties, failure or inquiries, inform your ADT Co., Ltd. representative of the following information.

- 1) Inverter type (Refer to Chapter 1, Section 1.1.)
- 2) SER No. (serial number of equipment) (Refer to Chapter 1, Section 1.1.)
- 3) Function codes and their data that you changed from the factory defaults (Refer to Chapter 3, Section 3.4.2.)
- 4) ROM version (Refer to Chapter 3, Section 3.4.5.)
- 5) Date of purchase
- 6) Inquiries (for example, point and extent of breakage, uncertainties, failure phenomena, and other circumstances)
- 7) Production year & week (Refer to Chapter 1, Section 1.1.)

7.4.2 Product warranty

To all our customers who purchase 58 H Co., Ltd. products included in this documentation:

Please take the following items into consideration when placing your order.

When requesting an estimate and placing your orders for the products included in these materials, please be aware that any items such as specifications which are not specifically mentioned in the contract, catalog, specifications or other materials will be as mentioned below.

In addition, the products included in these materials are limited in the use they are put to and the place where they can be used, etc., and may require periodic inspection. Please confirm these points with your sales representative or directly with this company.

Furthermore, regarding purchased products and delivered products, we request that you take adequate consideration of the necessity of rapid receiving inspections and of product management and maintenance even before receiving your products.

[1] Free of charge warranty period and warranty range

- (1) Free of charge warranty period
 - 1) The product warranty period is 18 months from the manufacturing date imprinted on the name place.
 - 2) However, in cases where the use environment, conditions of use, use frequency and times used, etc., have an effect on product life, this warranty period may not apply.
 - 3) Furthermore, the warranty period for parts restored by ADT Co., Ltd.'s Service Department is "6 months from the date that repairs are completed."

(2) Warranty range

- 1) In the event that breakdown occurs during the product's warranty period which is the responsibility of ADT Co., Ltd., ADT Co., Ltd. will replace or repair the part of the product that has broken down free of charge at the place where the product was purchased or where it was delivered. However, if the following cases are applicable, the terms of this warranty may not apply.
 - ① The breakdown was caused by inappropriate conditions, environment, handling or use methods, etc. which are not specified in the catalog, operation manual, specifications or other relevant documents.
 - ② The breakdown was caused by the product other than the purchased or delivered ADT Co., Ltd.'s product.
 - ③ The breakdown was caused by the product other than ADT Co., Ltd.'s product, such as the customer's equipment or software design, etc.
 - ④ Concerning the ADT Co., Ltd.'s programmable products, the breakdown was caused by a program other than a program supplied by this company, or the results from using such a program.
 - ⑤ The breakdown was caused by modifications or repairs affected by a party other than ADT Co., Ltd.
 - ⑥ The breakdown was caused by improper maintenance or replacement using consumables, etc. specified in the operation manual or catalog, etc.
 - ⑦ The breakdown was caused by a science or technical problem that was not foreseen when making practical application of the product at the time it was purchased or delivered.
 - ⑧ The product was not used in the manner the product was originally intended to be used.
 - ⑨ The breakdown was caused by a reason which is not this company's responsibility, such as lightning or other disaster.
- 2) Furthermore, the warranty specified herein shall be limited to the purchased or delivered product alone.
- 3) The upper limit for the warranty range shall be as specified in item (1) above and any damages (damage to or loss of machinery or equipment, or lost profits from the same, etc.) consequent to or resulting from breakdown of the purchased or delivered product shall be excluded from coverage by this warranty.

(3) Trouble diagnosis

As a rule, the customer is requested to carry out a preliminary trouble diagnosis. However, at the customer's request, this company or its service network can perform the trouble diagnosis on a chargeable basis. In this case, the customer is asked to assume the burden for charges levied in accordance with this company's fee schedule.

[2] Exclusion of liability for loss of opportunity, etc.

Regardless of whether a breakdown occurs during or after the free of charge warranty period, this company shall not be liable for any loss of opportunity, loss of profits, or damages arising from special circumstances, secondary damages, accident compensation to another company, or damages to products other than this company's products, whether foreseen or not by this company, which this company is not be responsible for causing.

[3] Repair period after production stop, spare parts supply period (holding period)

Concerning models (products) which have gone out of production, this company will perform repairs for a period of 7 years after production stop, counting from the month and year when the production stop occurs. In addition, we will continue to supply the spare parts required for repairs for a period of 7 years, counting from the month and year when the production stop occurs. However, if it is estimated that the life cycle of certain electronic and other parts is short and it will be difficult to procure or produce those parts, there may be cases where it is difficult to provide repairs or supply spare parts even within this 7-year period. For details, please confirm at our company's business office or our service office.

[4] Transfer rights

In the case of standard products which do not include settings or adjustments in an application program, the products shall be transported to and transferred to the customer and this company shall not be responsible for local adjustments or trial operation.

[5] Service contents

The cost of purchased and delivered products does not include the cost of dispatching engineers or service costs. Depending on the request, these can be discussed separately.

[6] Applicable scope of service

Above contents shall be assumed to apply to transactions and use of the country where you purchased the products.

Consult the local supplier or ADT Co., Ltd. for the detail separately.

⚠ WARNING ⚠

To prevent the risk of hazardous accidents that could be caused by damage of the inverter, install the specified MCCB in the supply side (primary side) according to the following tables.

- Breaking capacity: Min. 10 kA
- Rated voltage: Min. 500 V

Power supply voltage	Applicable motor rating (kW)	Inverter type	Fuse Rating (A)	Rated Current(A) of MCCB (w/o DCR)
Three-phase 400 V	0.4	U1-0040-4	3	6
	0.75	U1-0075-4	6	
	1.5	U1-0150-4	10	10
	2.2	U1-0220-4	15	15
	3.7	U1-0370-4	20	20
Single-phase 200 V	0.4	U1-0040-7	10	10
	0.75	U1-0075-7	15	15
	1.5	U1-0150-7	30	20
	2.2	U1-0220-7	40	35

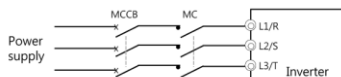

Chapter 8 SPECIFICATIONS

8.1 Standard Models

8.1.1 Single-phase 200 V class series

Item		Specifications			
Type		0.4	0.75	1.5	2.2
Applicable motor rating (kW) *1		0.4	0.75	1.5	2.2
Output Ratings	Rated capacity (kVA) *2	0.9	1.6	2.8	3.8
	Rated voltage (V) *3	Three-phase, 200 to 240 V (with AVR function)			
	Rated current (A) *4	3.5 (2.5)	4.2 (4.2)	9.2 (7.5)	10.0 (10.0)
	Overload capability	150% of rated output current for 1 min or 200% of rated output current for 0.5 s (for the rated current given in parentheses)			
	Rated frequency (Hz)	50/60 Hz			
Input Ratings	Phases, voltage, frequency	Single-phase, 200 to 240 V, 50/60 Hz			
	Voltage and frequency variations	Voltage: +10 to -10%, Frequency: +5 to -5%			
	Rated current (A) *6	(w/o DCR) 5.4	9.7	16.4	24.0
	Required power supply capacity (kVA) *7	0.7	1.3	2.4	3.5
Braking	Torque (%) *8	100		50	30
	DC braking	Braking starting frequency*9: 0.0 to 60.0 Hz, Braking time: 0.0 to 30.0 s, Braking level: 0 to 100%			
	Braking transistor	Built-in			
Applicable safety standards		UL61800-5-1, IEC 61800-5-1(under application)			
Enclosure		IP20 (IEC 60529), UL open type (UL50)			
Cooling method		Fan cooling			
Mass (kg)		0.6	0.6	1.0	1.0

*1 Fuji 4-pole standard motors

*2 Refers to the rated capacity assuming the rated output voltage as 220 V.

*3 Output voltages cannot exceed the power supply voltage.

*4 The load shall be reduced so that the continuous operating current is the rated current in parentheses or less if the carrier frequency is set to 3 kHz or above or the ambient temperature exceeds 40°C.

*5 Interphase voltage unbalance (%) = $\frac{\text{Max. voltage (V)} - \text{Min. voltage (V)}}{3 - \text{phase average voltage (V)}} \times 67$ (Refer to IEC 61800 - 3)

If this value is 2 to 3%, use an optional AC reactor (ACR).

*6 Refers to the estimated value to apply when the power supply capacity is 500 kVA (inverter capacity x 10 when the inverter capacity exceeds 50 kVA) and the inverter is connected to the %X = 5% power supply.

*8 Refers to the average braking torque to apply when the motor running alone decelerates from 60 Hz with the AVR control being OFF. (It varies with the efficiency of the motor.)

*9 Available only for induction motor drive.

8.1.2 Three-phase 400 V class series

Item		Specifications					
Type		0.4	0.75	1.5	2.2	3.7	
Applicable motor rating (kW) *1		0.4	0.75	1.5	2.2	3.7	
Output Ratings	Rated capacity (kVA) *2	1.1	1.9	3.2	4.1	6.8	
	Rated voltage (V) *3	Three-phase, 380 to 480 V (with AVR function)					
	Rated current (A)	1.8 (1.5)	2.5 (2.5)	4.3 (4.2)	6.3 (5.5)	10.5 (9.0)	
	Overload capability	150% of rated output current for 1 min or 200% of rated output current for 0.5 s (for the rated current given in parentheses)					
	Rated frequency (Hz)	50/60 Hz					
Input Ratings	Phases, voltage, frequency	Three-phase, 380 to 480 V, 50/60 Hz					
	Voltage and frequency variations	Voltage: +10 to -15% (Interphase voltage unbalance: 2% or less) *5, Frequency: +5 to -5%					
	Rated current (A) *6	(w/o DCR)	1.7	3.1	5.9	8.2	13.0
	Required power supply capacity (kVA) *7		0.6	1.1	2.0	2.9	4.9
Braking	Torque (%) *8		100	50		30	
	DC braking	Braking starting frequency*9: 0.0 to 60.0 Hz, Braking time: 0.0 to 30.0 s, Braking level: 0 to 100%					
	Braking transistor	Built-in					
Applicable safety standards		UL61800-5-1, IEC 61800-5-1 (under application)					
Enclosure		IP20 (IEC 60529), UL open type (UL50)					
Cooling method		Natural cooling			Fan cooling		
Mass (kg)		0.8	0.8	0.9	0.9	1.3	

*1 Fuji 4-pole standard motors

*2 Refers to the rated capacity assuming the rated output voltage as 440 V.

*3 Output voltages cannot exceed the power supply voltage.

*5 Interphase voltage unbalance (%) = $\frac{\text{Max. voltage (V)} - \text{Min. voltage (V)}}{3\text{-phase average voltage (V)}} \times 67$ (Refer to IEC 61800-3)

If this value is 2 to 3%, use an optional AC reactor (ACR).

*6 Refers to the estimated value to apply when the power supply capacity is 500 kVA (inverter capacity x 10 when the inverter capacity exceeds 50 kVA) and the inverter is connected to the %X = 5% power supply.

*8 Refers to the average braking torque to apply when the motor running alone decelerates from 60 Hz with the AVR control being OFF. (It varies with the efficiency of the motor.)

*9 Available only for induction motor drive.

8.2 Terminal Specifications

8.2.1 Terminal functions

For details about the main and control circuit terminals, refer to Chapter 2, Section 2.3.5 and Section 2.3.6 (Table 2.7), respectively.

8.2.2 Connection diagram in operation by external signal inputs

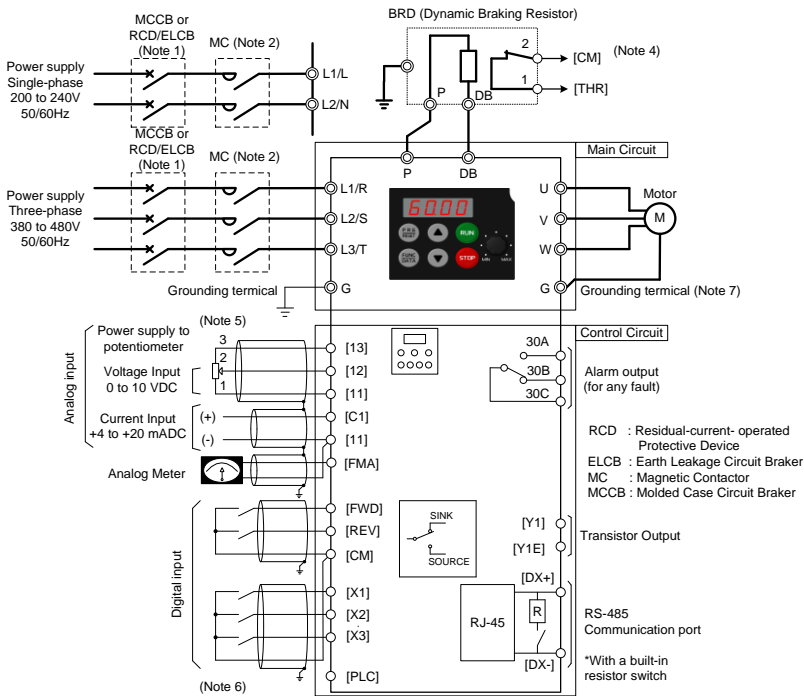

(Note 1) Install a recommended molded case circuit breaker (MCCB) or a residual-current-operated protective device (RCD)/earth leakage circuit breaker (ELCB) (with overcurrent protection) in the primary circuit of the inverter to protect wiring. Do not use an MCCB or RCD/ELCB whose capacity exceeds the recommended rated current.

(Note 2) A magnetic contactor (MC) should, if necessary, be mounted independent of the MCCB or ELCB to cut off the power fed to the inverter. MCs or solenoids that will be installed close to the inverter require surge absorbers to be connected in parallel to their coils.

(Note 4) The **THR** function can be used by assigning "9" (External alarm) to any of terminals [X1] to [X3], [FWD] or [REV] (function code E01 to E03, E98, or E99).

(Note 5) Frequency can be set by connecting a frequency setting device (external potentiometer) between terminals [11], [12], and [13] instead of inputting voltage signal (0 to +10 VDC or 0 to +5 VDC) between terminals [12] and [11].

- (Note 6) For the wiring of the control circuit, use shielded or twisted wires. When using shielded wires, connect the shields to earth. To prevent malfunction due to noise, keep the control circuit wiring away from the main circuit wiring as far as possible (recommended: 10 cm or longer), and never set them in the same wire duct. When crossing the control circuit wiring with the main circuit wiring, set them at right angles.
- (Note 7) It is recommended for noise control that 3-phase, 4-wire cable be used for the motor wiring.
Connect grounding wires of the motor to the grounding terminal G on the inverter.

The basic connection diagram above is for running/stopping the inverter and setting the frequency with external signals. Given below are connection notes.



- (1) Set function code F02 to "1" (External signals).
- (2) Set function code F01 to "1" (Voltage input to terminal [12]) or "2" (Current input to terminal[C1]).
- (3) Short-circuit terminals [FWD] and [CM] to run the motor in the forward direction and opening them to stop it. Short-circuit terminals [REV] and [CM] to run the motor in the reverse direction and opening them to stop it.
- (4) Frequency by voltage input is within the range from 0 to +10 VDC or 0 to the maximum frequency. Frequency by current input is within the range from +4 to +20 mADC or 0 to the maximum frequency.

8.3 Protective Functions

"—": Not applicable.

Name	Description	LED monitor displays	Alarm output [30A,B,C]	
Overcurrent protection Short-circuit protection Ground fault protection	<ul style="list-style-type: none"> - Stops the inverter output to protect the inverter from an overcurrent resulting from overload. - Stops the inverter output to protect the inverter from an overcurrent due to a short circuit in the output circuit. - Stops the inverter output to protect the inverter from an overcurrent due to a ground fault in the output circuit. This protection is effective only when the inverter starts. If you turn on the inverter without removing the ground fault, this protection may not work. 	During acceleration OC1 During deceleration OC2 During running at constant speed OC3	Yes	
Overvoltage protection	Stops the inverter output upon detection of overvoltage (400 VDC for 200 V series and 800 VDC for 400 V series) in the DC link bus. This protection is not assured if excess AC line voltage is applied inadvertently.	During acceleration OU1 During deceleration OU2 During running at constant speed (Stopped) OU3	Yes	
Under voltage protection	Stops the inverter output when the DC link bus voltage drops below the under voltage level (200 VDC for 200 V series and 400VDC for 400 V series). However, when F14 = 4 or 5, no alarm is output even if the DC link bus voltage drops.	LU	Yes (Note)	
Input phase loss protection	Detects input phase loss, stopping the inverter output. This function prevents the inverter from undergoing heavy stress that may be caused by input phase loss or inter-phase voltage unbalance and may damage the inverter. If connected load is light or a DC reactor is connected to the inverter, this function may not detect input phase loss if any. In single-phase series of inverters, this function is disabled by factory default.	Lin	Yes	
Output phase loss protection	Detects breaks in inverter output wiring at the start of running and during running, stopping the inverter output.	OPL	Yes	
Overheat protection	Inverter	- Stops the inverter output upon detecting excess heat sink temperature in case of cooling fan failure or overload.	OH1	Yes
	Braking resistor	- Protects the braking resistor from overheat in accordance with the setting of the electronic thermal overload relay for braking resistor. * It is necessary to set the function code data according to the braking resistor used (built-in or external).	dbH	Yes
Overload protection	Stops the inverter output according to the inverter heat sink temperature and the switching element temperature calculated from the output current.	OLU	Yes	

(Note) No alarm output depending upon the data setting of the function code.

Name		Description	LED monitor displays	Alarm output [30A,B,C]
Motor protection	Electronic thermal overload relay	<p>Stops the inverter output in accordance with the setting of the electronic thermal overload relay to protect the motor.</p> <p>This function protects general-purpose motors and inverter motors over the entire frequency range, as well as protecting the 2nd motor.</p> <p>* The operation level and thermal time constant (0.5 to 75.0 minutes) can be set.</p>	OL1 OL2	Yes
	PTC thermistor	<p>A PTC thermistor input stops the inverter output for motor protection.</p> <p>A PTC thermistor is connected between terminals [C1] and [11], and a resistor is connected between terminals [13] and [C1].</p>	OH4	Yes
	Overload early warning	Outputs a preliminary alarm at a preset level before the motor is stopped by the electronic thermal function for the purpose of protecting the motor.	—	—
Stall prevention	Operates if the inverter's output current exceeds the instantaneous overcurrent limit level, avoiding tripping of the inverter (during constant speed operation or during acceleration).	—	—	
External alarm input	Stops the inverter output with an alarm through the digital input signal THR .	OH2	Yes	
Alarm relay output (for any fault)	<p>The inverter outputs a relay contact signal when the inverter issues an alarm and stops the inverter output.</p> <p>< Alarm Reset ></p> <p>The alarm stop state is reset by pressing the  key or by the digital input signal RST.</p> <p>< Saving the alarm history and detailed data ></p> <p>The information on the previous 4 alarms can be saved and displayed.</p>	—	Yes	
Memory error	The inverter checks memory data after power-on and when the data is written. If a memory error is detected, the inverter stops.	Er1	Yes	
CPU error	If the inverter detects a CPU error caused by noise or some other factor, the inverter stops.	Er3	Yes	
Operation error	STOP key priority	Pressing the  key on the keypad forces the inverter to decelerate and stop the motor even if the inverter is running by any run commands given via the terminals or communications (link operation). After the motor stops, the inverter issues alarm Er6.	Er6	Yes
	Start check function	<p>Inverters prohibit any run operations and displays Er6 on the LED monitor if a run command is present at the time of any of the following status changes.</p> <ul style="list-style-type: none"> - Powering up - An alarm ( key turned ON) is released or an alarm reset (RST) is input. - Link command (LE) has switched inverter operation and the run command in the source to be switched is active. 		

Name	Description	LED monitor displays	Alarm output [30A,B,C]
Tuning error *1	Stops the inverter output when a tuning failure, interruption, or abnormal tuning result is detected during tuning of motor parameters.	Er7	Yes
RS-485 communication error	Upon detection of an RS-485 communications error, the inverter stops its output.	Er8	Yes
Data save error during under voltage	If the data could not be saved during activation of the under voltage protection function, the inverter displays the alarm code.	ErF	Yes
Retry function	When the inverter stops due to a trip, this function automatically resets the inverter and restarts it. (The number of retries and the latency between stop and reset can be specified.)	—	—
Surge protection	Protects the inverter against surge voltages which might appear between one of the power lines for the main circuit and the ground.	—	—
Protection against momentary power failure	Upon detection of a momentary power failure lasting 15 ms or more, this function stops the inverter output. If "restart after momentary power failure" is selected, this function invokes a restart process when power has been restored within a predetermined period.	—	—
Overload prevention control	In the event of overheating of the cooling fan or an overload condition (alarm display: OH1 or OLU), the output frequency of the inverter is reduced to keep the inverter from tripping.	—	—
Mock alarm	A mock alarm can be generated with keypad operations to check the failure sequence.	Err	Yes
PID feedback wire break detection	Upon detection of a PID feedback wire break, this function outputs an alarm.	CoF	Yes

*1 Available only for induction motor drive.

8.4 External Dimensions

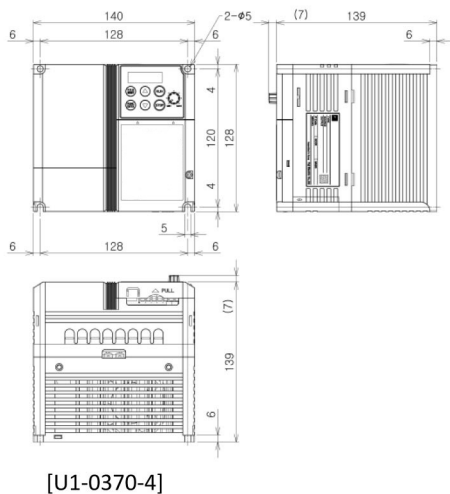
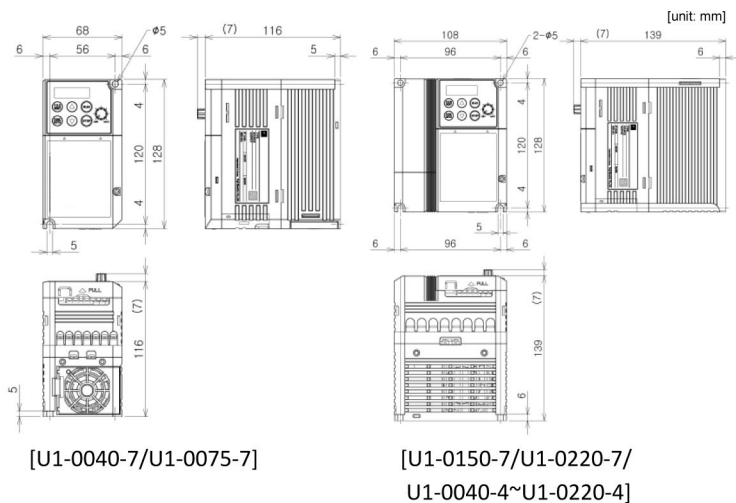

Advanced simple Inverter
iMaster-U1

**Instruction
Manual**

First Edition,
SEP 2017

ADT Co., Ltd.

The purpose of this instruction manual is to provide accurate information in handling, setting up and operating of the iMaster-U1 of inverters. Please feel free to send your comments regarding any errors or omissions you may have found, or any suggestions you may have for generally improving the manual.

In no event will ADT Co., Ltd. be liable for any direct or indirect damages resulting from the application of the information in this manual.



ADT Co., Ltd.

56 Beolmalro, Dongangu, Anyangshi, Kyunggido, 14059 Korea

Phone: +82-31-459-5051

Fax: +82-31-459-5053

URL <http://www.adtech21.com>

2017-09 (F13a/C13)

