



Automation for a Changing World

Delta High Performance Compact Drive MH300 Series



 www.deltaww.com

 **DELTA**
Smarter. Greener. Together.

Compact and Intelligent

The new standard for micro drives

The automation industry today continues to face challenges such as increasing competition and rising costs. In addition to improving productivity and reducing labor, the driving force for automation is the shift to higher efficiency, optimal quality, and most importantly, flexibility and compatibility for a wide range of applications.

The MH300 series is the new generation high performance compact vector control drive that inherits Delta's drive technology with more advanced functions included for higher application flexibility -- all in a compact drive that has been reduced 71% in size.

A variety of essential functions are built-in as standard, including: PLC capacity for simple programming needs, communication slots for various communication cards, and a USB port to make data uploads and downloads fast and easy. This saves the need for additional hardware, while providing more installation space for the power cabinet. Other key features include: support for both IM and PM motor control for application flexibility, an STO function to ensure worry-free operation while protecting facilities from damage, and a simplified wiring process with a new screwless wiring design of terminal blocks for quick installation.

Saving space, reducing setup and wiring time, and providing high efficiency and a highly stable system, the MH300 is your key to improving market competitiveness and ensuring success.





Models Overview

Standard Models
Exterior Design
Option Cards

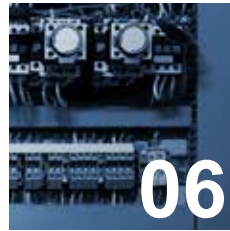

Optimized Space Utilization

Compact Design
Side-by-Side Installation



Outstanding Drive Performance

Supports IM and PM Motors
High Starting Torque
Enhanced Braking Capability
Fast Response to Load Impact
Deceleration Energy Backup (DEB)



Strong System Support

Multi-motor Control
Pulse Control
Built-in PLC
Tension Control
DC 24 V External Power
High Overload Capability
Built-in Brake Chopper
Closed-Loop Control
Various Communications



Wide Range of Applications

Rewinder Machines
Slitter Machines
Printing Machines
Drawing Machines
Coil Winding Machines
Machine Tools
Woodworking Machines
Textile Machines



Stable, Safe and Reliable

Safety Standards Compliance
Enhanced Conformal Coating
Built-in EMC Filter
IP40 Models



Easy to Install

Application Parameter Settings
Built-in USB port
Screwless Wiring of Control Terminal



Specifications

Product Specifications
Wiring
Dimensions
Accessories
Model Name Explanation
Ordering Information

Models Overview



Standard Models

115V single-phase

Applicable Motor Output (kW)	0.2	0.4	0.75
Applicable Motor Output (HP)	0.25	0.5	1
Frame Size	A		C

230V single-phase

Applicable Motor Output (kW)	0.2	0.4	0.75	1.5	2.2
Applicable Motor Output (HP)	0.25	0.5	1	2	3
Frame Size	A		B	C	

230V single-phase (Built-in EMC filter)

Applicable Motor Output (kW)	0.2	0.4	0.75	1.5	2.2
Applicable Motor Output (HP)	0.25	0.5	1	2	3
Frame Size	B			C	

230V 3-phase

Applicable Motor Output (kW)	0.2	0.4	0.75	1.5	2.2	3.7/4	5.5	7.5	11	15	18.5	22	30	37
Applicable Motor Output (HP)	0.25	0.5	1	2	3	5	7.5	10	15	20	25	30	40	50
Frame Size	A			B	C		D	E		F	G		I	

460V 3-phase

Applicable Motor Output (kW)	0.4	0.75	1.5	2.2	3.7/4	5.5	7.5	11	15	18.5	22	30	37	45	55	75
Applicable Motor Output (HP)	0.5	1	2	3	5	7.5	10	15	20	25	30	40	50	60	75	100
Frame Size	A		B	C		D		E		F		G	H		I	

460V 3-phase (Built-in EMC filter)

Applicable Motor Output (kW)	0.4	0.75	1.5	2.2	3.7/4	5.5	7.5	11	15	18.5	22	30	37	45	55	75
Applicable Motor Output (HP)	0.5	1	2	3	5	7.5	10	15	20	25	30	40	50	60	75	100
Frame Size	B		C		D		E		F		G	H		I		

Exterior Design

Compact design and user-friendly interface

Removable Keypad

Press to remove; supports remote operation away from drive



5 digits 16 segments LCD display, quick setting wheel dial, left-shift function key

Removable RFI Jumper

Applicable for different application needs



Built-in USB Port

Easy and fast programming setting, update and real-time monitoring and tuning



Label with Product Details

Including input / output currents, voltage and protection level



Screwless Top Cover Design

Press on both side tabs to remove the cover



Removable Fan



Easy to replace and maintain for a longer lifetime





Option Cards

A wide selection of option cards for highly flexible applications



PG Cards

<p>EMM-PG01L ABZ Signal Line driver</p> 	<p>EMM-PG01O ABZ Signal Open collector</p> 
<p>EMM-PG01R Resolver Suitable for PM motors</p> 	

I/O Cards

<p>EMM-D33A I/O</p> 	<p>EMM-A22A Analog</p> 
--	---

Relay Cards

<p>EMM-R3AA Form A *3</p> 	<p>EMM-R2CA Form C *2</p> 
--	--







External Power Supply Card (DC 24V)

EMM-BPS02



Communication Cards

<p>PROFIBUS DP CMM-PD02</p> 	<p>DeviceNet CMM-DN02</p> 
<p>EtherNet/IP Modbus TCP CMM-EIP02</p> 	<p>EtherNet/IP Modbus TCP CMM-EIP03</p> 
<p>EtherCAT CMM-EC02</p> 	



Optimized Space Utilization

Compact Design

Provides more powerful features in smaller sizes with reduction up to 71% that effectively optimizes the installation space



Note: VFD32AMH43ANSAA versus VFD150B43A

Side-by-Side Installation

Supports side-by-side installation with operating temperatures of $-20^{\circ}\text{C} \sim 40^{\circ}\text{C}$; enables highly flexible and highly efficient installation

Substantial savings in space!



Outstanding Drive Performance

Supports IM and PM Motors

Built-in 4 independent induction motor control parameter sets and supports up to 8 independent induction motor control parameter sets

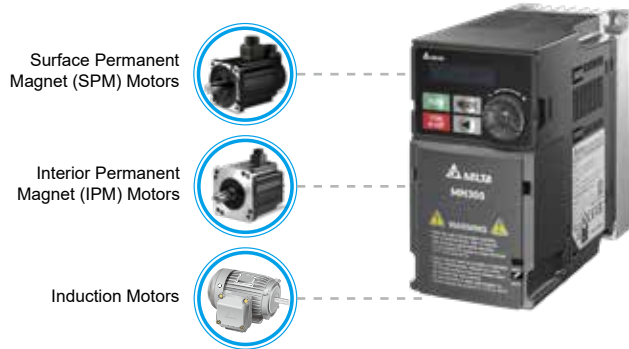

High Starting Torque

Delivers 200% high starting torque with a low speed control of 0.5 Hz (sensor-less vector control)* and provides outstanding machine stability; suitable for dynamic loading applications

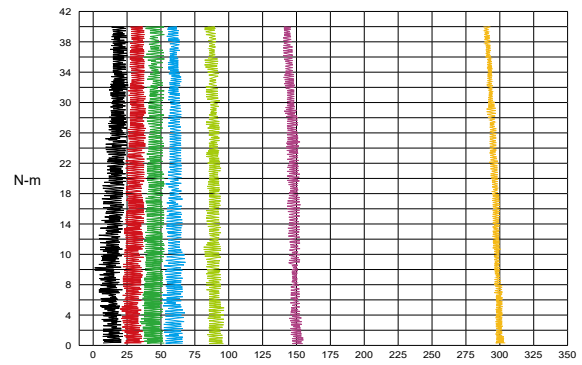

* Note: Additive PG vector control delivers 200% high starting torque with a speed control of 0Hz

Enhanced Braking Capability

Provides Deceleration Energy Control Mode to shorten braking time by adjusting the motor speed and current, replacing break resistors

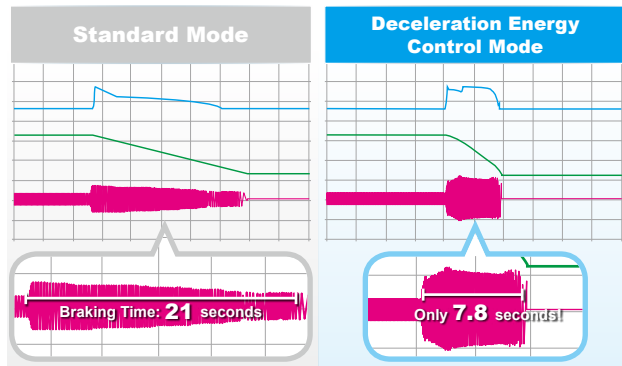

* Actual deceleration performance would depend on different system loads

Fast Response to Load Impact

Fast response to sudden load impact at speeds to ensure stable operation and high quality output

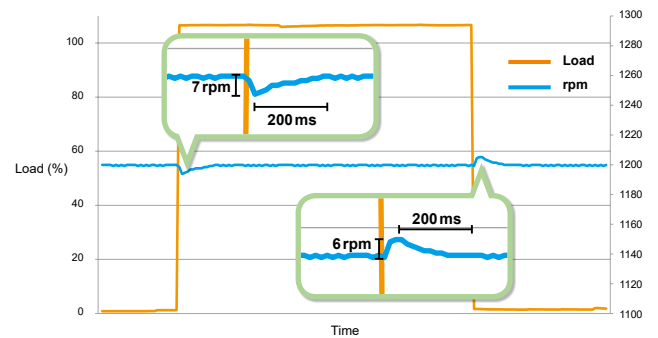

Deceleration Energy Backup (DEB)

Controls the motor deceleration to a stop when an unexpected power shut-down occurs to prevent mechanical damage; the motor will accelerate to its previous speed when power resumes

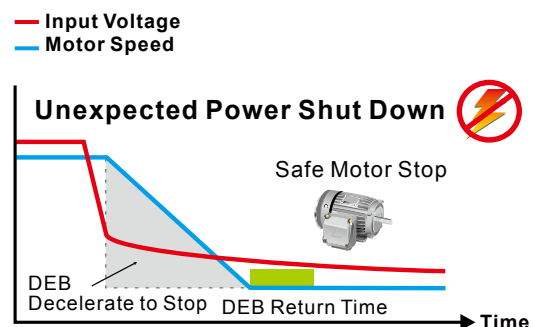
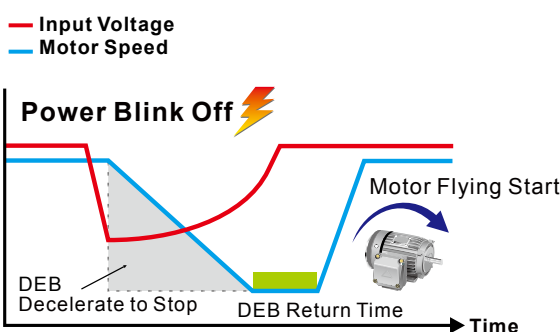

Strong System Support

Multi-motor Control

Switching control of 8 induction motors

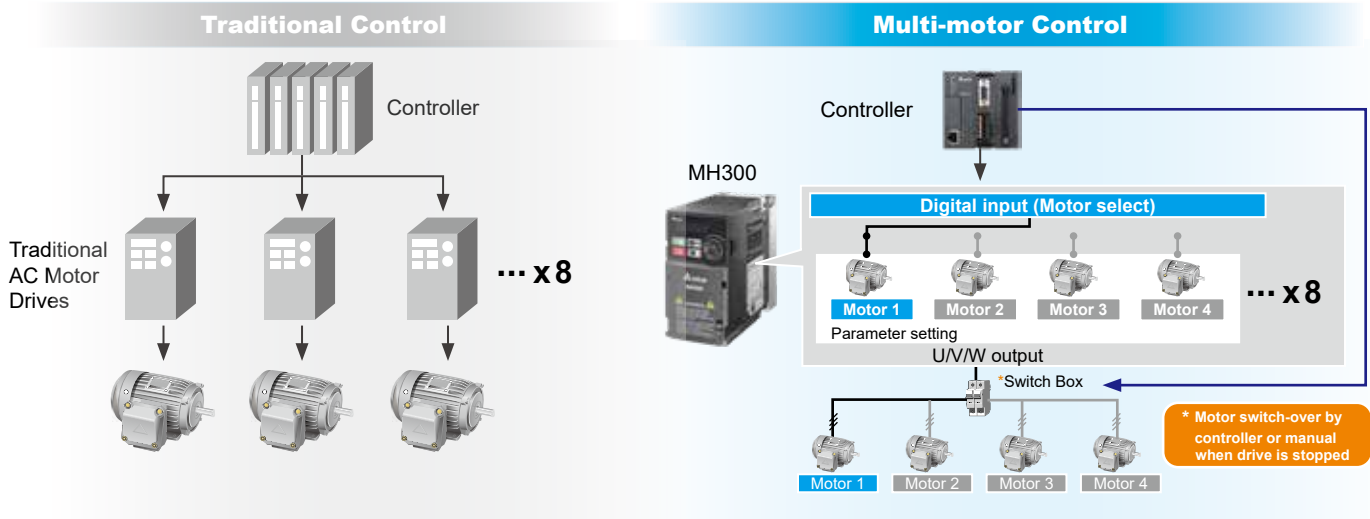

Note: MH300 features 4 built-in independent parameters sets and through the built-in PLC program, it supports up to 8 independent parameters sets

Pulse Input

Supports a dual pulse input signal from controller or a feedback signal from encoder without an additional PG card to achieve simple closed-loop control. Terminal MI7 supports single pulse signal input as a frequency command

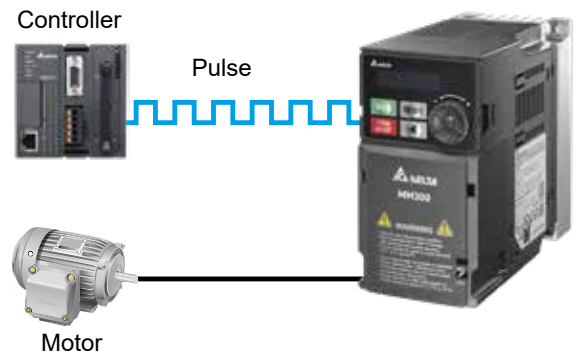

Built-in PLC

Built-in PLC capacity (5k steps) provides distributed control and independent operation via network connection

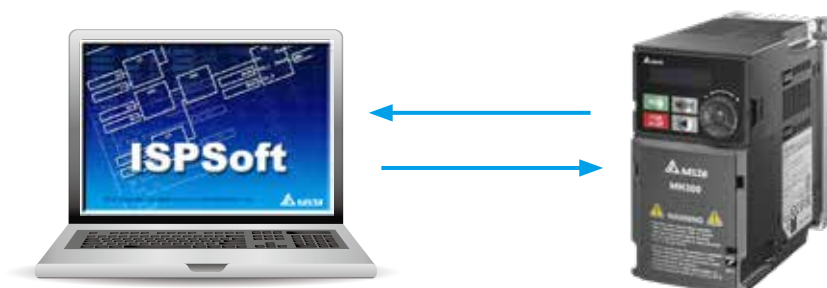

Tension Control

- Built-in coil diameter calculation: through linear velocity, material thickness, and range finder
- 2 PID parameter settings: supports linear adjustment to control tension at the start, between sizes and different linear velocities
- Tensile taper calculation: automatically adjust tension while wrapup to avoid crease folding or deformation
- Auto lap changing: on-power refueling with external signal
- Friction and inertia compensation during torque control: automatically compensate friction and inertia of rewinding and unwinding reels to maintain steady tensions

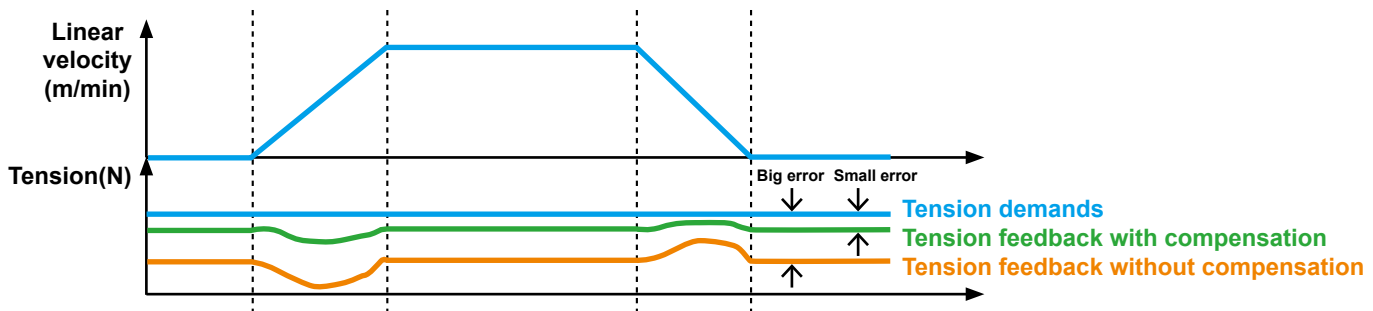

- Supports open / closed-loop, torque and speed tension controls

• Closed-loop tension, speed control

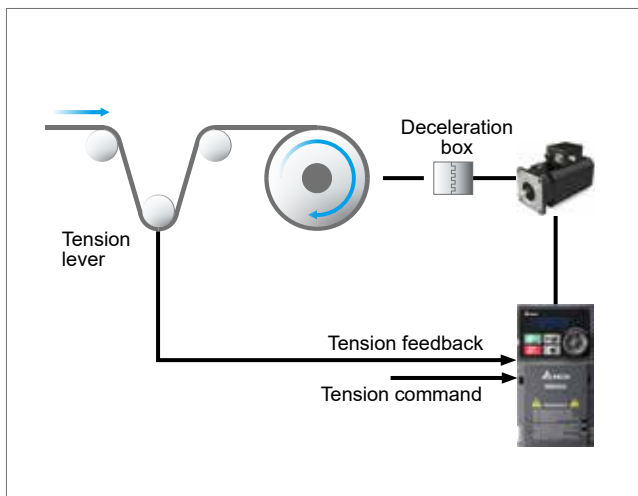

• Closed-loop tension, torque control

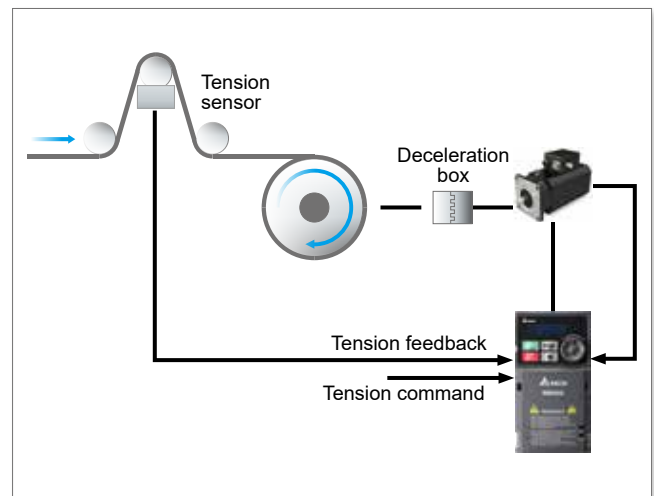

• Open-loop tension, torque control

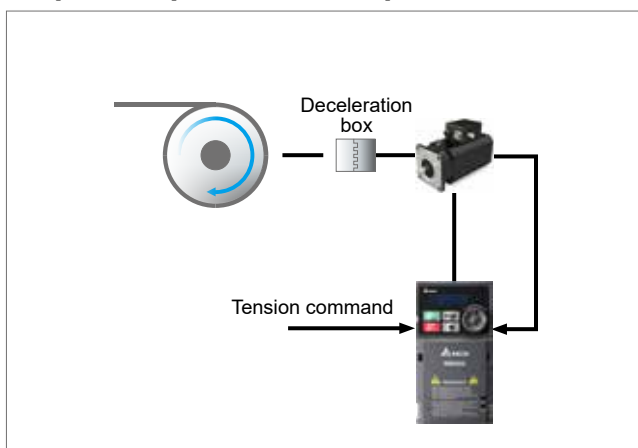

• Steady linear velocity control

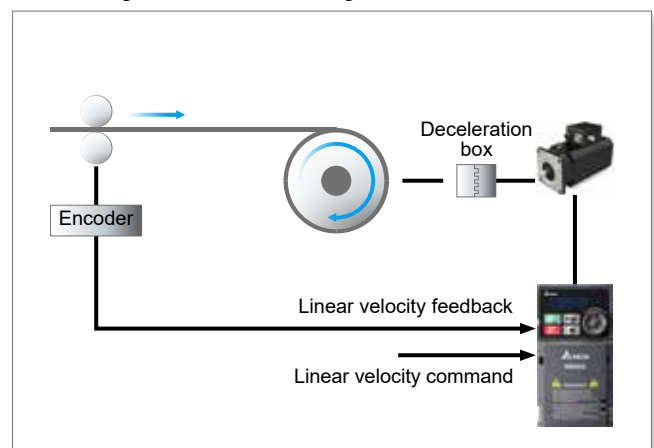

DC 24V External Power

External power supply card is available for external power connection to protect the system and ensure uninterrupted communication when mains power failure occurs

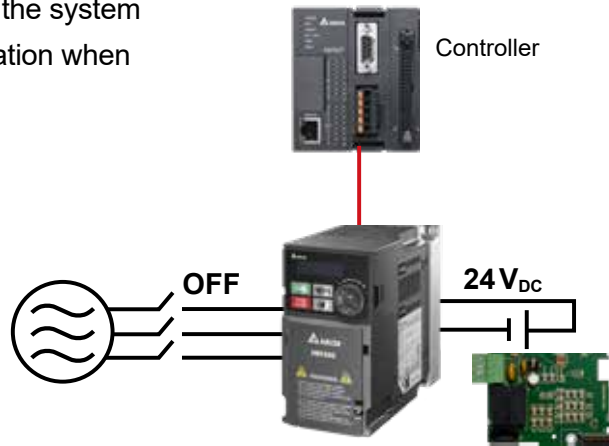

High Overload Capability

- Normal duty: rated current 120% for 60 seconds; 150% for 3 seconds
- Heavy duty: rated current 150% for 60 seconds; 200% for 3 seconds

Built-in Braking Chopper

Larger braking torque capability is provided when using an additional braking resistor

Closed-Loop Control

Optional PG card is available to support closed-loop control function and to provide higher precision of motor speed control

Various Communications

Built-in RS-485 (Modbus) and CANopen communication; other communication options are available upon selection

Communication	
Modbus	Built-in
PROFIBUS DP	Optional
DeviceNet	Optional
Modbus TCP	Optional
EtherNet/IP	Optional
CANopen	Built-in
EtherCAT	Optional

Wide Range of Applications



Rewinding Machines

Features and Benefits

- Built-in tension control features for timely response compared to the external controller (ex. PLC); stable tension with coil diameter calculation
- Built-in 2 PID parameter settings for stable tension through the whole production
- Built-in tensile taper calculation to automatically adjust tension while wrapup to avoid crease folding or deformation
- Supports common DC bus to decrease electricity consumption by recovering rewinding energy for unwinding



Slitter Machines

Features and Benefits

- Control by inverters overcomes the drawbacks of a magnetic powder clutch, such as low operating speed, high temperature, and short lifetime
- Timely acceleration/deceleration control improves machinery operation efficiency and supports weak magnetic control to increase slitter speed and save energy
- Automatically compensates friction and inertia of rewinding and unwinding reels to maintain steady tensions
- Supports both induction motors and PM motors



Printing Machines

Features and Benefits

- Built-in 2 PID parameter settings and coil diameter calculation for stable tension with big/small reels, and high/low linear velocity
- Built-in tensile taper calculation to automatically adjust tension while wrapup to avoid crease folding or deformation
- Auto lap changing for on-power refueling with external signal
- Supports common DC bus to decrease electricity consumption by recovering rewinding energy for unwinding



Drawing Machines

Features and Benefits

- Built-in master and sub-carrier frequency control with PID control enables quick response and stable tension to avoid line disconnection
- Low-frequency heavy torque fulfills the torque requirement during low speed and quickly complete threading
- 100% PCB coating to enhances the durability for humid, corrosive, and dusty environments



Coil Cutting Tool

Features and Benefits

- Easy and handy PID control fulfills the requirement of steady tension during high/low linear velocity and avoids belt or cable damages
- Features smart start control to avoid belt damage caused by excessive instantaneous tension during the start
- Built-in brake chopper saves system implementation cost
- Compact design for optimized space efficiency



Machine Tools

Features and Benefits

- Supports PG cards for closed-loop control; suitable for complex and high precision processing applications
- Timely acceleration/deceleration control improves machinery operation efficiency
- Built-in brake chopper saves on purchasing cost
- Built-in PLC capacity for flexible application needs
- Built-in STO function ensures operator safety and effectively reduces accident risk
- Provides deceleration-to-stop function



Woodworking Machines

Features and Benefits

- Timely acceleration/ deceleration control improves machinery operation efficiency
- Built-in STO function ensures operator safety and effectively reduces accident risk
- Built-in PLC capacity saves on purchasing cost
- Built-in EMC filter effectively reduces electromagnetic interference
- Compact in size and weight, easy to install and maintain



Textile Machines

Features and Benefits

- IP40 models provide excellent protection from a high dust, fiber or moisture environment
- Improved heatsink design prevents fiber clogging the air way; modular design of fan is easy to clean and provides longer lifetime
- Improved braking capability shortens the deceleration-to-stop time and is suitable for sudden stop requirements
- Built-in STO function ensures operator safety and effectively reduces accident rate
- Supports both induction motors and PM motors
- Provides deceleration-to-stop function to protect the equipment from damage when sudden power failure occurs



Stable, Safe and Reliable



Safety Standard

Integrated Safe Torque Off (STO), compliance with:

- ▶ ISO 13849-1: 2015 Category 3 PL d
- ▶ EN 61508 SIL2
- ▶ EN 60204-1 Category 0
- ▶ EN 62061 SIL CL 2

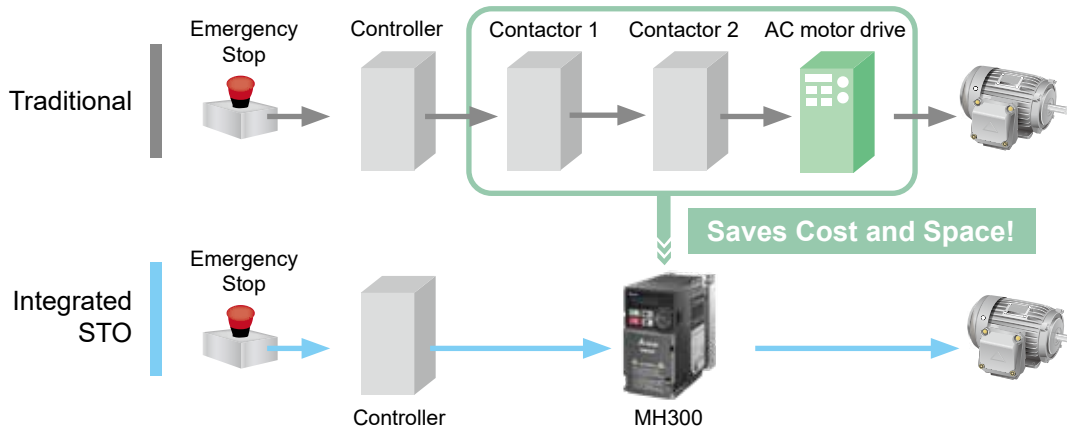

PCB Coating

100% PCB coating (IEC 60721-3-3 class 3C2 standard) ensures drive operation stability and safety in critical environments

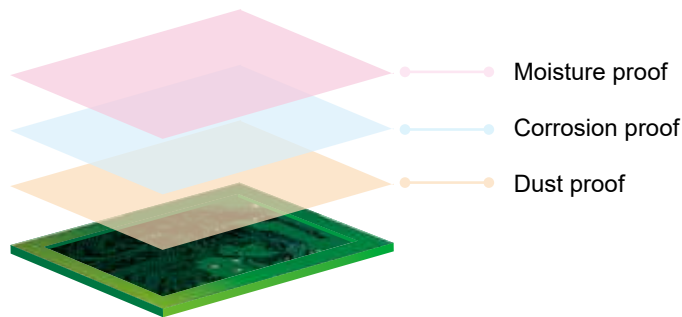

IP 40 Models

Strengthened fan coating and concealed air vent prevent dust and other particles from entering the drive, suitable for critical environment applications



Built-in EMC Filter

Built-in Class A (C2) standard EMC filter; saves on additional procurement cost and wiring time, and provides more cabinet space for other devices to use

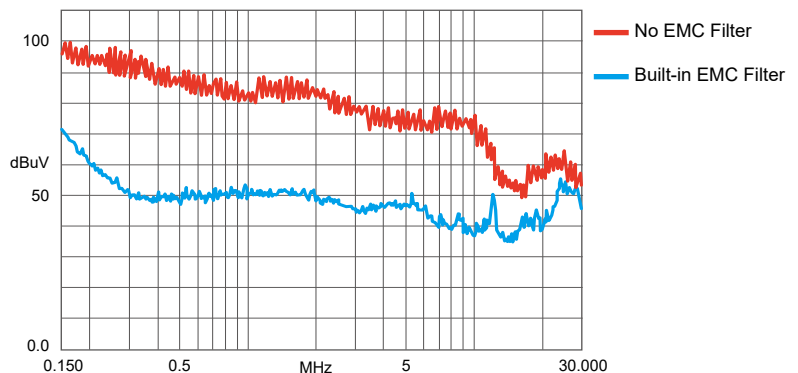

Easy to Install

Application Groups (Macro)

Simplifies the parameter setting process by grouping the parameters for different applications to use

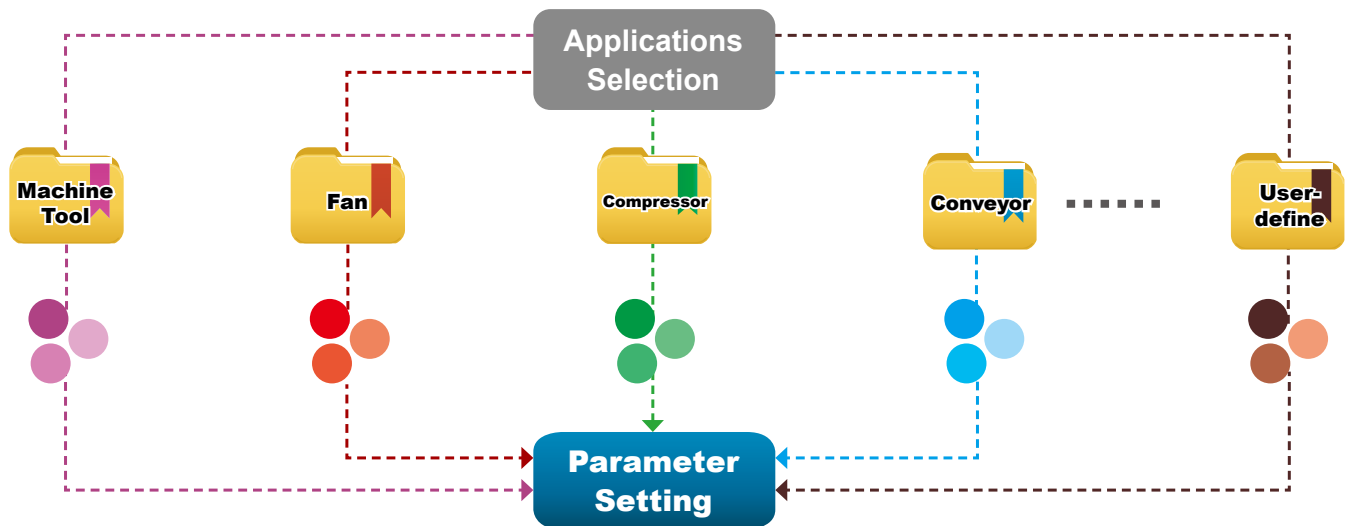

Built-in USB Port

Built-in USB port facilitates the drive setting, updating, real-time monitoring and system tuning process

- No need of USB or RS-485 connectors
- Supports offline (drive power off) parameter setting/copying and system update

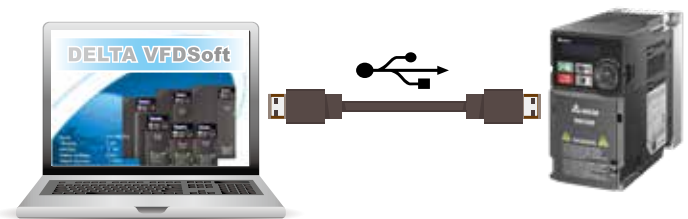

Screwless Wiring of Control Terminal

Spring clamp terminal blocks provide fast and easy wiring

No need for special tools and saves wiring time

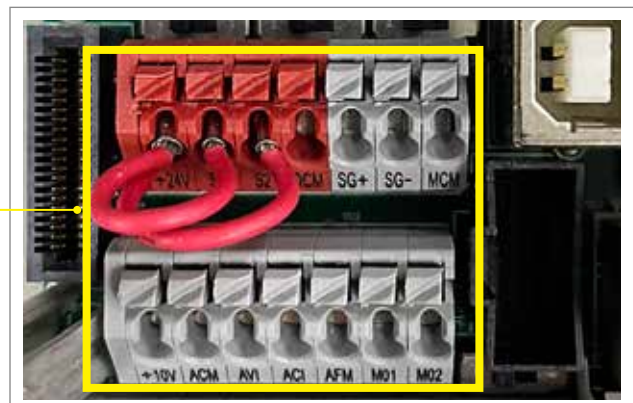

Specifications



Single-phase
115V

			Models w/o Built-in EMC Filter		
Frame			A		C
Applicable Motor Output (kW)			0.2	0.4	0.75
Applicable Motor Output (HP)			1/4	1/2	1
Inverter Output	Heavy Duty	Rated Output Current (A)	1.6	2.5	5
	Normal Duty	Rated Output Current (A)	1.8	2.7	5.5
Input	Rated Voltage/Frequency		1-Phase AC 100V~120V (-15%~+10%), 50/60Hz		
	Mains Input Voltage Range		85~132V		
	Mains Frequency Range		47~63Hz		
Carrier Frequency (kHz)			2~15 (default 4)		
Brake Chopper			Built-in		
DC Reactor			Optional		
AC Reactor			Optional		
Cooling Method			Natural air cooling		Fan cooling
Size: W×H (mm)			68×128		87×157
Size: D (mm)			130	144	167

Single-phase
230V

			Models with Built-in EMC Filter				
Frame			B		C		
Applicable Motor Output (kW)			0.2	0.4	0.75	1.5	2.2
Applicable Motor Output (HP)			1/4	1/2	1	2	3
Inverter Output	Heavy Duty	Rated Output Current (A)	1.6	2.8	5	7.5	11
	Normal Duty	Rated Output Current (A)	1.8	3.2	5.2	8.5	12.5
Input	Rated Voltage/Frequency		1-Phase AC 200V~240V (-15%~+10%), 50/60Hz				
	Mains Input Voltage Range		170~265V				
	Mains Frequency Range		47~63Hz				
Carrier Frequency (kHz)			2~15 (default 4)				
Brake Chopper			Built-in				
DC Reactor			Optional				
AC Reactor			Optional				
Cooling Method			Natural air cooling	Fan cooling			
Size: W×H (mm)			72x142			87x157	
Size: D (mm)			174			194	
			Models w/o an EMC Filter				
Frame			A		B	C	
Cooling Method			Natural air cooling			Fan cooling	
Size: W×H (mm)			68×128	68×128	72×142	87×157	
Size: D (mm)			130	144	162	167	

Product Specifications

3-phase
230V

Models w/o Built-in EMC Filter													
Frame			A		B	C		D	E		F		
Applicable Motor Output (kW)			0.2	0.4	0.75	0.75	1.5	2.2	3.7/4	5.5	7.5	15	
Applicable Motor Output (HP)			1/4	1/2	1	1	2	3	5	7.5	10	20	
Inverter Output	Heavy Duty	Rated Output Current (A)	1.6	2.8	5	5	7.5	11	17	25	33	49	65
	Normal Duty	Rated Output Current (A)	1.8	3.2	5.2	5.2	8	12.5	19.5	27	36	51	69
Input	Rated Voltage/Frequency		3-Phase AC 200 V ~ 240 V (-15% ~ +10%), 50 / 60 Hz										
	Mains Input Voltage Range		170~265V										
	Mains Frequency Range		47~63Hz										
Carrier Frequency (kHz)			2~15kHz (default 4kHz)										
Brake Chopper			Built-in										
DC Reactor			Optional										
AC Reactor			Optional										
Cooling Method			Natural air cooling				Fan cooling						
Size: W×H (mm)			68x128				72x142	87x157	109x207	130x250	175x300		
Size: D (mm)			144	144	162	150	158	167	169	200	207		

Models w/o an EMC Filter												
Frame			G				I					
Applicable Motor Output (kW)			18.5				22		30		37 (45) ^(Note)	
Applicable Motor Output (HP)			25				30		40		50 (60) ^(Note)	
Inverter Output	Heavy Duty	Rated Output Current (A)	75				90		120		146	
	Normal Duty	Rated Output Current (A)	81				102		134		160	
Input	Rated Voltage/Frequency		3-Phase AC 200 V ~ 240 V (-15% ~ +10%), 50 / 60 Hz									
	Mains Input Voltage Range		170~265V									
	Mains Frequency Range		47~63Hz									
Carrier Frequency (kHz)			2~15kHz (default 4kHz)									
Brake Chopper			Built-in				Optional					
DC Reactor			Optional				Built-in					
AC Reactor			Optional									
Cooling Method			Fan cooling									
Size: W×H (mm)			250x400				330x550					
Size: D (mm)			225				300					

Note: Values in the brackets are the applicable motor output under normal duty

3-phase
460 V

Models with Built-in EMC Filter

Frame			B		C		D		E		F			
Applicable Motor Output (kW)			0.4	0.75	0.75	1.5	2.2	3.7/4	5.5	7.5	11	15	18.5	22
Applicable Motor Output (HP)			1/2	1	1	2	3	5	7.5	10	15	20	25	30
Inverter Output	Heavy Duty	Rated Output Current (A)	1.5	3	3	4.2	5.7	9	13	17.5	25	32	38	45
	Normal Duty	Rated Output Current (A)	1.8	3.3	3.3	4.6	6.5	10.5	14.5	19.8	28	36	41.5	49
Input	Rated Voltage/Frequency		3-Phase AC 380V~480V (-15%~+10%), 50/60Hz											
	Mains Input Voltage Range		323~528V											
	Mains Frequency Range		47~63Hz											
Carrier Frequency (kHz)			2~15kHz (default 4kHz)											
Brake Chopper			Built-in											
DC Reactor			Optional											
AC Reactor			Optional											
Cooling Method			Fan cooling											
Size: W×H (mm)			72x142				87x157		109x207		130x250		175x300	
Size: D (mm)			174				194		202		234		259	

Models w/o an EMC Filter

Frame			A		B		C		D		E		F	
Cooling Method			Natural air cooling		Fan cooling									
Size: W×H (mm)			68x128		72x142		87x157		109x207		130x250		175x300	
Size: D (mm)			144	162	150	158	167		169		200		207	

3-phase
460 V

Models with Built-in EMC Filter

Frame			G		H		I					
Applicable Motor Output (kW)			30		37		45		55		75	
Applicable Motor Output (HP)			40		50		60		75		100	
Inverter Output	Heavy Duty	Rated Output Current (A)	60		75		91		112		150	
	Normal Duty	Rated Output Current (A)	69		85		108		128		180	
Input	Rated Voltage/Frequency		3-Phase AC 380V~480V (-15%~+10%), 50/60Hz									
	Mains Input Voltage Range		323~528V									
	Mains Frequency Range		47~63Hz									
Carrier Frequency (kHz)			2~15kHz (default 4kHz)									
Brake Chopper			Built-in		Optional							
DC Reactor			Optional		Built-in							
AC Reactor			Optional									
Cooling Method			Fan cooling									
Size: W×H (mm)			250x400		280x500				330x550			
Size: D (mm)			225		280				300			

Models w/o an EMC Filter

Frame			G		H		I					
Cooling Method			Fan cooling									
Size: W×H (mm)			250x400		280x500				330x550			
Size: D (mm)			225		280				300			

General Specifications and Accessories

Control Functions	Control Methods	V/F, SVC, FOC, V/F+PG, FOC+PG, TQC+PG		
	Applicant Motors	Induction motors (IM), Interior Permanent Magnet (IPM) motors, and Surface Permanent Magnet (SPM) motors		
	Max. Output Frequency	599Hz		
	Starting Torque*	150%/3 Hz 200%/0.5 Hz 200%/0 Hz 100%/(1/20 of motor rated frequency) 150%/0 Hz 200%/0 Hz	(V/f, SVC, V/F+PG control for IM, Heavy duty) (FOC control for IM, Heavy duty) (FOC+PG control for IM, Heavy duty) (SVC control for PM, Heavy duty) (FOC control for PM, Heavy duty) (Closed-loop vector control w/PG for PM, Heavy duty)	
	Speed Control Range*	1 : 50 (V/f, SVC, V/F+PG control for IM, Heavy duty) 1 : 100 (FOC control for IM, Heavy duty) 1 : 1000 (FOC+PG control for IM, Heavy duty)	1 : 20 (SVC control for PM, Heavy duty) 1 : 100 (FOC control for PM, Heavy duty) 1 : 1000 (Closed-loop vector control w/PG for PM, Heavy duty)	
	Overload Tolerance	Normal Duty (ND): 120% of rated output current for 60 seconds; 150% of rated output current for 3 seconds Heavy Duty (HD): 150% of rated output current for 60 seconds; 200% of rated output current for 3 seconds		
	Frequency Setting Signal	0~+10V/-10V~+10V, 4~20mA/0~+10V, 2 Pulse input (33kHz), 1 Pulse output (33kHz)		
	Main Control Functions	multi-motor control motor switches (max. 8 independent motor parameter settings), fast startup, Deceleration Energy Back (DEB) function, wobble frequency function, fast deceleration function, master and auxiliary frequency source selectable, momentary power loss ride thru, speed search, over-torque detection, torque limit, 16-step speed (max.), accel/decel time switch, S-curve accel/decel, 3-wire sequence, JOG frequency, upper/lower limits for frequency reference, DC injection braking at start and stop, PID control, built-in PLC (5K steps), positioning function, tension control, Modbus and CANopen integrated as standard		
Protection Functions	Motor Protection	overcurrent protection, overvoltage protection, over-temperature protection, phase failure protection, overload protection, output grounding protection		
	Stall Prevention	stall prevention during acceleration, deceleration and running independently		
Accessories	Communication Cards	PROFIBUS DP, DeviceNet, Modbus TCP, EtherNet/IP, EtherCAT		
	PG Cards	EMM-PG01L (ABZ, line driver) EMM-PG01O (ABZ, open collector)	EMM-PG01R (resolver)	
	I/O Expansion Cards	EMM-D33A (digital card - 3 in/3 out) EMM-A22A (analog card - 2 in/2 out)	EMM-R2CA (relay card (output: A *3)) EMM-R3AA (relay card (output: A *3))	
	External DC Power Supply	EMM-BPS02 (DC 24V power supply card)		
Digital Controller	A removable keypad as standard			
Certifications	CE, RCM, REACH, RoHS, TUV, UL			

*Control accuracy may vary depending on the environment, application conditions, different motors or encoder. For details, please contact our company or your local distributor.

Operating Environment

Operating Environment	Installation Location	IEC60364-1/IEC60664-1 Pollution degree 2, Indoor use only		
	Ambient Temperature	Operation	IP20/UL Open Type	-20 to 50 °C -20 to 60 °C (needs derating)
			IP40/NEMA 1/UL Type 1	-20 to 40 °C
			Zero stacking Installation	-20 to 50 °C (needs derating)
		Storage	-40 to 85 °C	
	Rated Humidity	Transportation	-20 to 70 °C	
		Operation	Max. 90%	
	Air Pressure	Storage/Transportation	Max. 95%	
		Operation	86~106 kPa	
	Pollution Level	Storage/Transportation	70~106 kPa	
Altitude	Compliance to IEC60721-3-3, 3C2			
Vibration	An altitude of 0~1000 m for normal operation (derating is required for installation at an altitude above 1000 m)			
Shock	Compliance to IEC 60068-2-6			
	Compliance to IEC/EN 60068-2-27			

Please refer to MH300 user manual for more details.

Wiring

Input: Single-phase/3-phase power

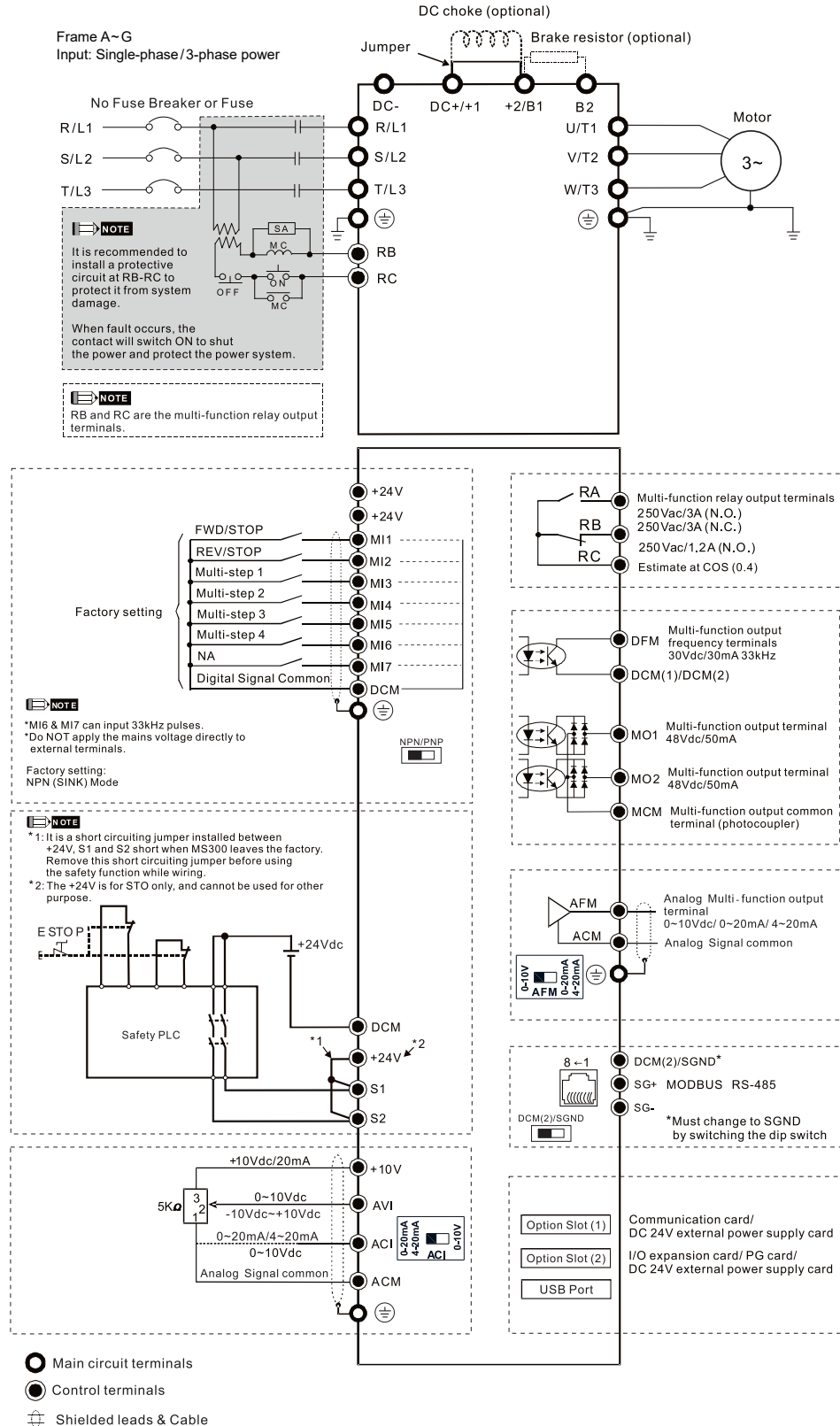

Note 1: please refer to MH300 user manual (chapter 7-4) for more details of DC choke
Note 2: please refer to MH300 user manual (chapter 7-1) for more details of brake resistor

Wiring

Input: Single-phase/3-phase power

Wiring Diagram for Frame H-I
It provides three-phase power

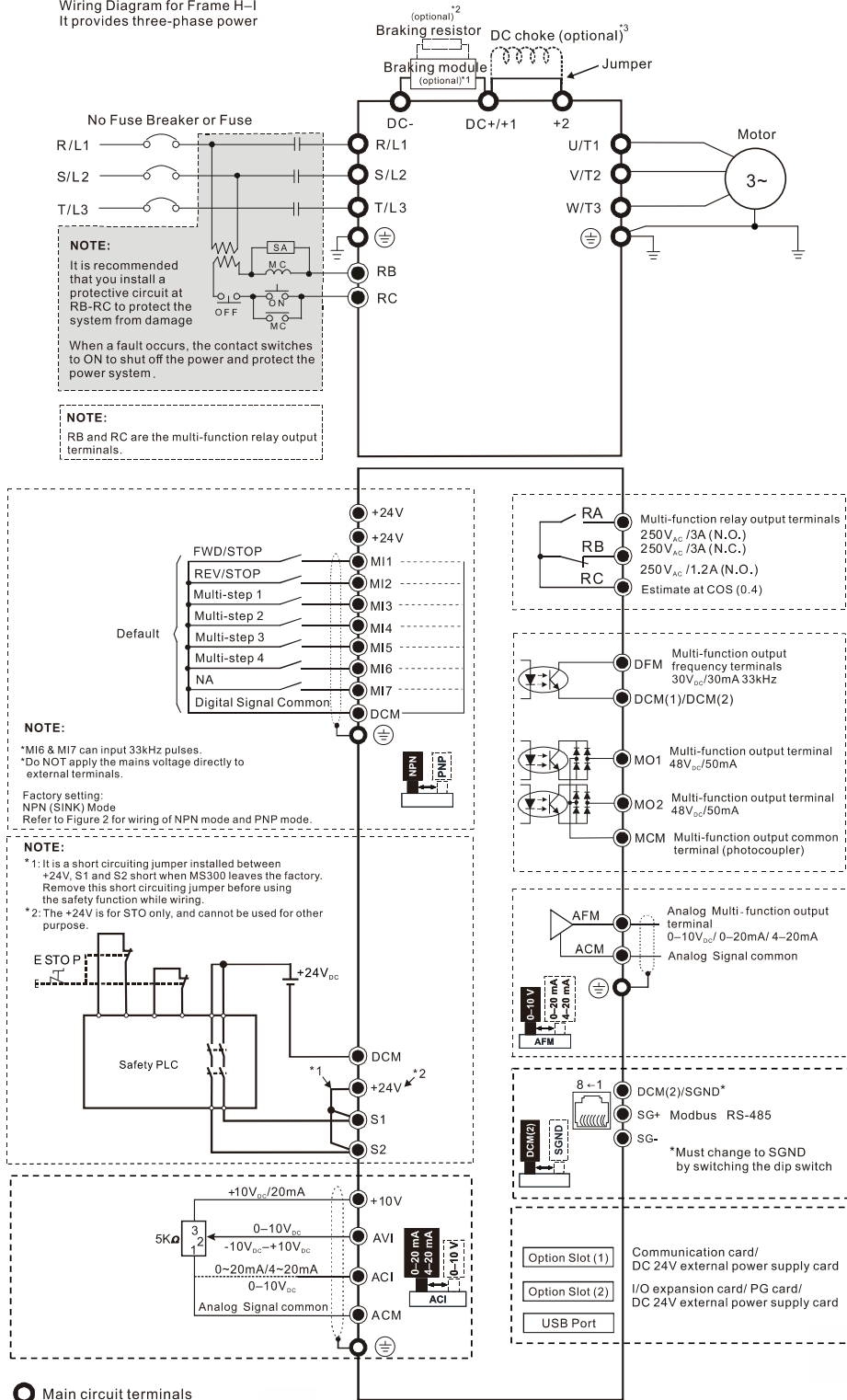

- Main circuit terminals
- Control terminals
- ⊕ Shielded leads & Cable

*1 & *2 Refer to Section 7-1 in the user manual for brake units and resistor selection.

*3 Refer to Section 7-4 in the user manual for DC reactor selection.

Dimensions

Frame A

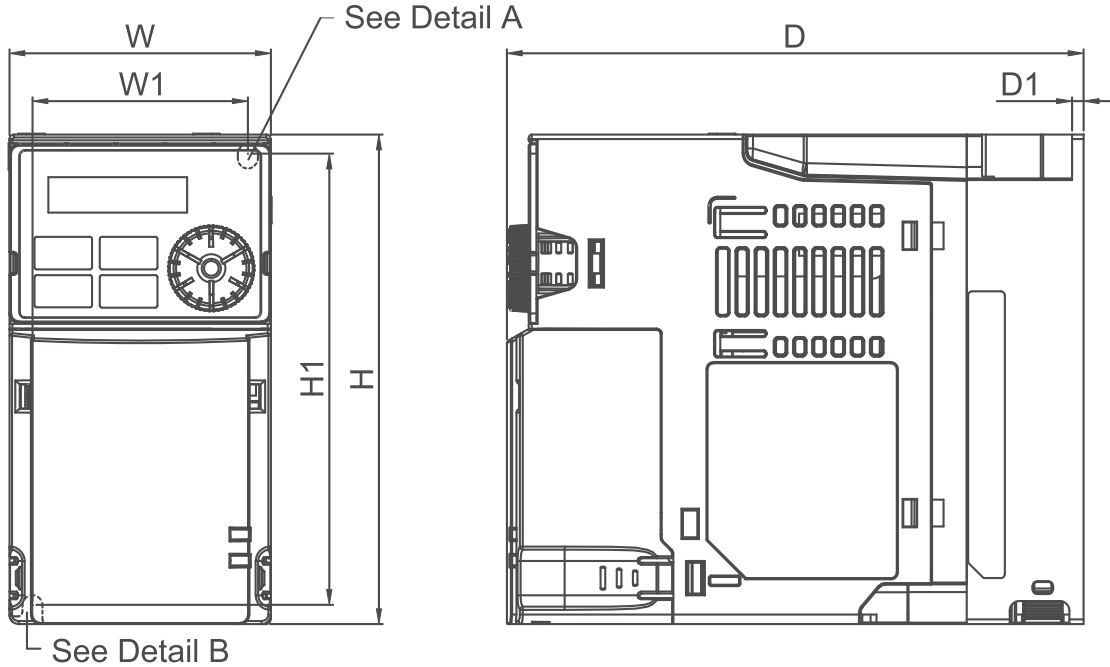

Detail A (Mounting Hole)

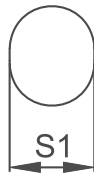

Detail B (Mounting Hole)

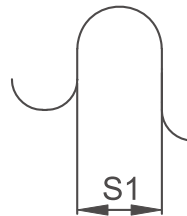

MODEL	FRAME A1	FRAME A2	FRAME A3	FRAME A4
VFD1A6MH11ANSAA	VFD2A5MH11ANSAA	VFD2A5MH11ENSAA	VFD5A0MH23ANSAA	VFD5A0MH23ANSNA
VFD1A6MH11ENSAA	VFD2A8MH21ANSAA	VFD2A8MH21ENSAA	VFD5A0MH23ENSAA	VFD5A0MH23ENSNA
VFD1A6MH21ANSAA	VFD1A6MH23ANSAA	VFD1A6MH23ENSAA	VFD3A0MH43ANSAA	VFD3A0MH43ANSNA
VFD1A6MH21ENSAA	VFD2A8MH23ANSAA	VFD2A8MH23ENSAA	VFD3A0MH43ENSAA	VFD3A0MH43ENSNA
	VFD1A5MH43ANSAA	VFD1A5MH43ENSAA		

Frame	W	H	D	W1	H1	D1	S1	
A1	mm	68.0	128.0	130.0	56.0	118.0	3.0	5.2
	inch	2.68	5.04	5.12	2.20	4.65	0.12	0.20
A2	mm	68.0	128.0	144.0	56.0	118.0	3.0	5.2
	inch	2.68	5.04	5.67	2.20	4.65	0.12	0.20

Frame	W	H	D	W1	H1	D1	S1	
A3	mm	68.0	128.0	150.0	56.0	118.0	3.0	5.2
	inch	2.68	5.04	5.91	2.20	4.65	0.12	0.20
A4	mm	68.0	128.0	162.0	56.0	118.0	3.0	5.2
	inch	2.68	5.04	6.38	2.20	4.65	0.12	0.20

Frame B

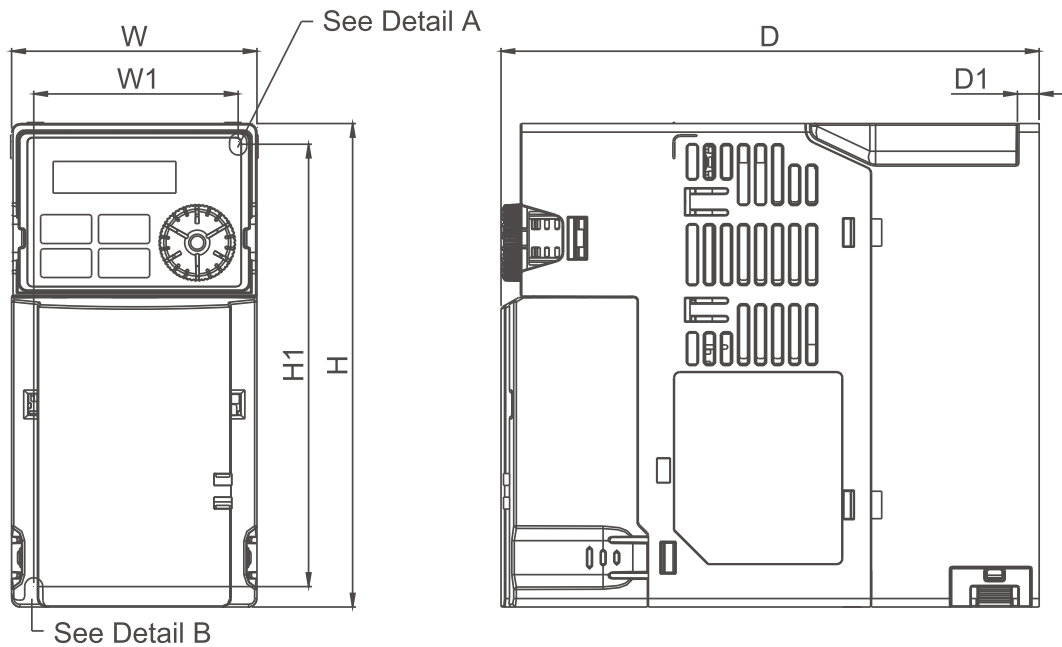

Detail A (Mounting Hole)

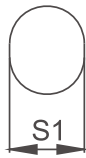

Detail B (Mounting Hole)



MODEL

FRAME B1

VFD7A5MH23ANSAA
VFD7A5MH23ENSAA
VFD4A2MH43ANSAA
VFD4A2MH43ENSAA

FRAME B2

Standard Models:
VFD5A0MH21ANSAA
VFD5A0MH21ENSAA

FRAME B3

VFD1A6MH21AFSAA
VFD2A8MH21AFSAA
VFD5A0MH21AFSAA
VFD3A0MH43AFSAA
VFD4A2MH43AFSAA

Frame		W	H	D	W1	H1	D1	S1
B1	mm	72.0	142.0	158.0	60.0	130.0	6.4	5.2
	inch	2.83	5.59	6.22	2.36	5.12	0.25	0.20
Frame		W	H	D	W1	H1	D1	S1
B2	mm	72.0	142.0	162.0	60.0	130.0	3.0	5.2
	inch	2.83	5.59	6.38	2.36	5.12	0.12	0.20
Frame		W	H	D	W1	H1	D1	S1
B3	mm	72.0	142.0	174.0	60.0	130.0	4.3	5.2
	inch	2.83	5.59	6.85	2.36	5.12	0.17	0.20

Frame C

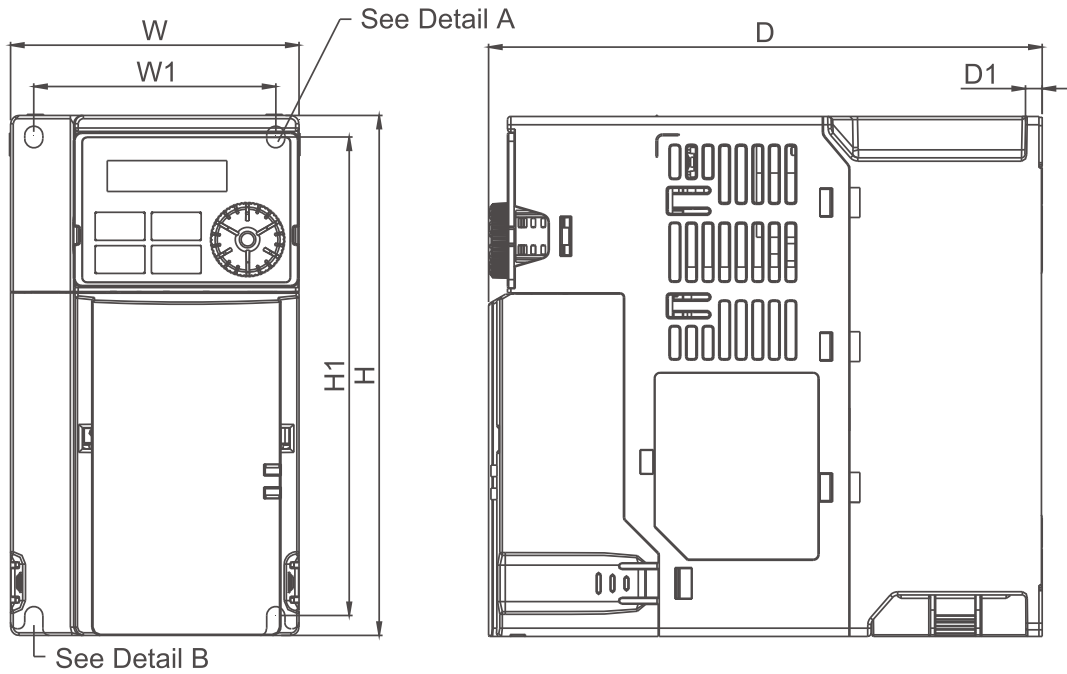

Detail A (Mounting Hole)

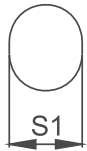

Detail B (Mounting Hole)



**MODEL
FRAME C1**

VFD5A0MH11ANSAA
 VFD7A5MH21ANSAA
 VFD11AMH21ANSAA
 VFD11AMH23ANSAA
 VFD17AMH23ANSAA
 VFD5A7MH43ANSAA
 VFD9A0MH43ANSAA

VFD5A0MH11ENSAA
 VFD7A5MH21ENSAA
 VFD11AMH21ENSAA
 VFD11AMH23ENSAA
 VFD17AMH23ENSAA
 VFD5A7MH43ENSAA
 VFD9A0MH43ENSAA

FRAME C2

VFD7A5MH21AFSAA
 VFD11AMH21AFSAA
 VFD5A7MH43AFSAA
 VFD9A0MH43AFSAA

Frame		W	H	D	W1	H1	D1	S1
C1	mm	87.0	157.0	167.0	73.0	144.5	5.0	5.5
	inch	3.43	6.18	6.57	2.87	5.69	0.20	0.22
Frame		W	H	D	W1	H1	D1	S1
C2	mm	87.0	157.0	194.0	73.0	144.5	5.0	5.5
	inch	3.43	6.18	7.64	2.87	5.69	0.20	0.22

Frame D

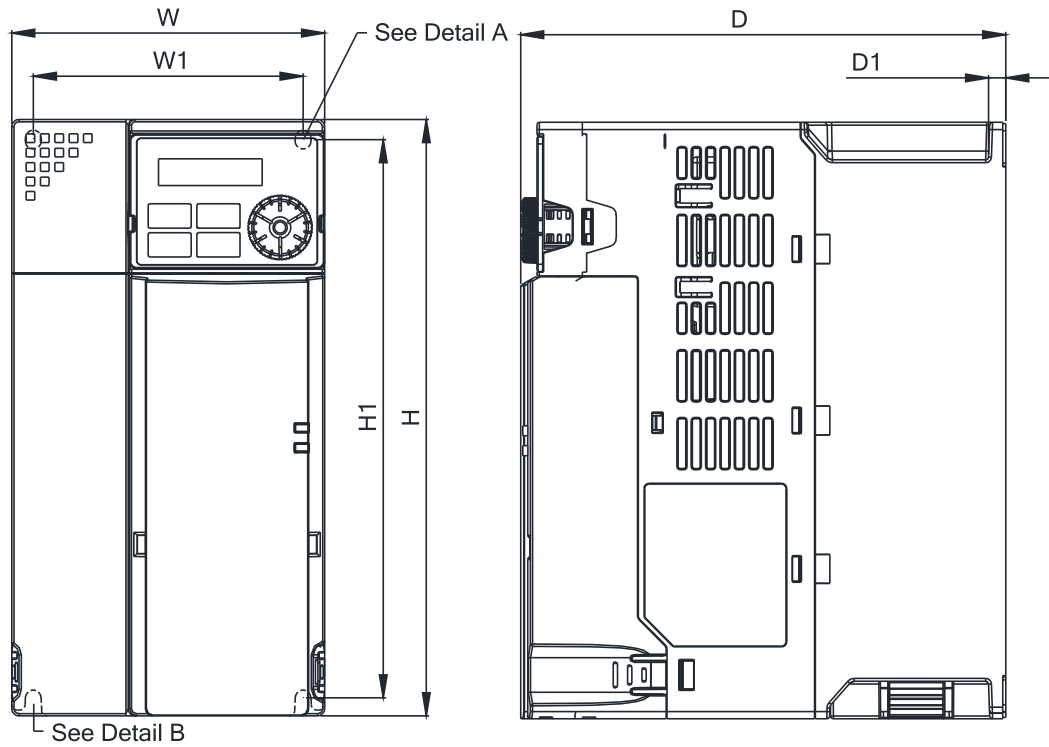

Detail A (Mounting Hole)

Detail B (Mounting Hole)

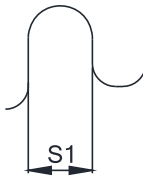

MODEL FRAME D1

VFD25AMH23ANSAA
VFD25AMH23ENSAA
VFD13AMH43ANSAA
VFD13AMH43ENSAA
VFD17AMH43ANSAA
VFD17AMH43ENSAA

FRAME D2

VFD13AMH43AFSAA
VFD17AMH43AFSAA

Frame		W	H	D	W1	H1	D1	S1
D1	mm	109.0	207.0	169.0	94.0	193.8	6.0	5.5
	inch	4.29	8.15	6.65	3.70	7.63	0.24	0.22
Frame		W	H	D	W1	H1	D1	S1
D2	mm	109.0	207.0	202.0	94.0	193.8	6.0	5.5
	inch	4.29	8.15	7.95	3.70	7.63	0.24	0.22

Frame E

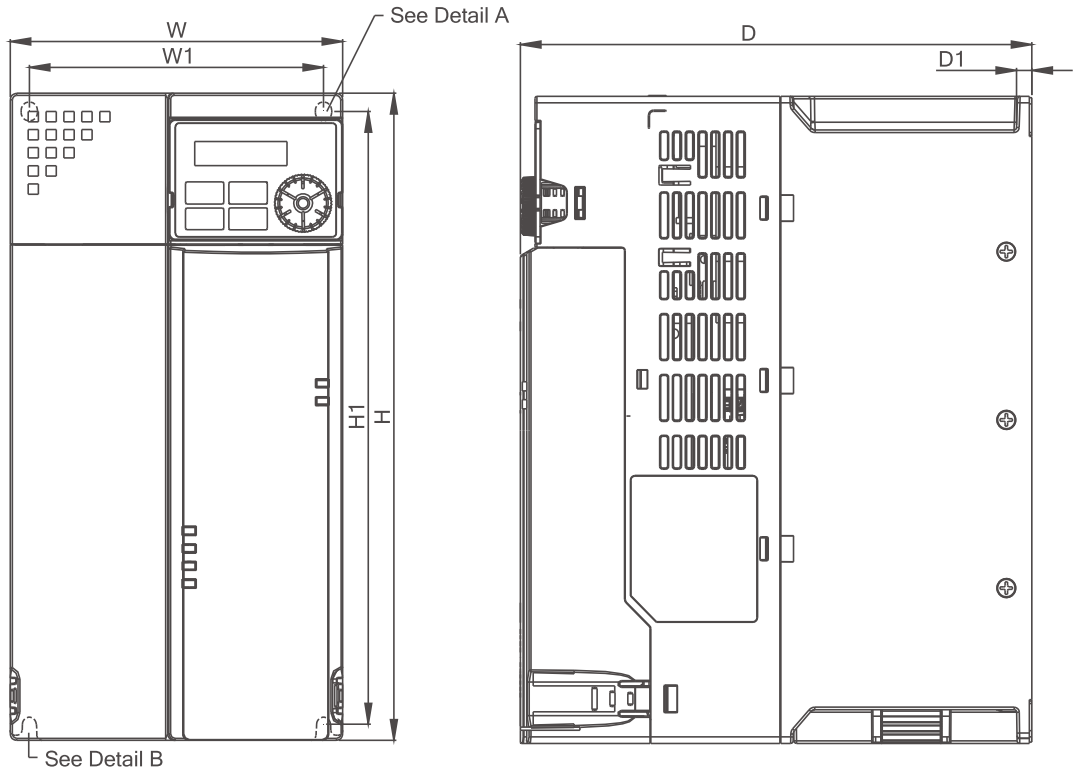

Detail A (Mounting Hole)

Detail B (Mounting Hole)

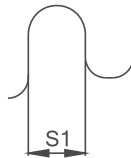

MODEL FRAME E1

FRAME E2

VFD33AMH23ANSAA
VFD33AMH23ENSAA
VFD49AMH23ANSAA
VFD49AMH23ENSAA
VFD25AMH43ANSAA
VFD25AMH43ENSAA
VFD32AMH43ANSAA
VFD32AMH43ENSAA

VFD25AMH43AFSAA
VFD32AMH43AFSAA

Frame		W	H	D	W1	H1	D1	S1
E1	mm	130.0	250.0	200.0	115.0	236.8	6.0	5.5
	inch	5.12	9.84	7.87	4.53	9.32	0.24	0.22
Frame		W	H	D	W1	H1	D1	S1
E2	mm	130.0	250.0	234.0	115.0	236.8	6.0	5.5
	inch	5.12	9.84	9.21	4.53	9.32	0.24	0.22

Frame F

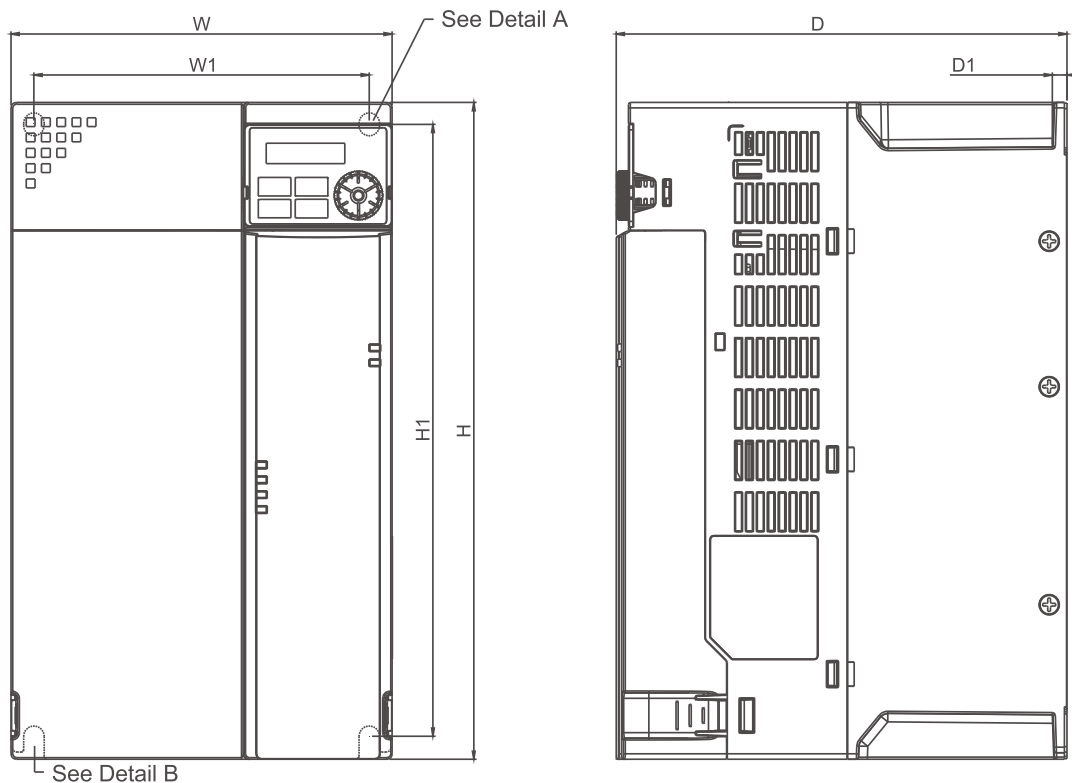

Detail A (Mounting Hole)

Detail B (Mounting Hole)

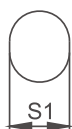

MODEL FRAME F1

Standard Models:
 VFD65AMH23ANSAA
 VFD65AMH23ENSAA
 VFD38AMH43ANSAA
 VFD38AMH43ENSAA
 VFD45AMH43ANSAA
 VFD45AMH43ENSAA

High Speed Models:
 VFD65AMH23ANSHA
 VFD65AMH23ENSHA
 VFD38AMH43ANSHA
 VFD38AMH43ENSHA
 VFD45AMH43ANSHA
 VFD45AMH43ENSHA

FRAME F2

Standard Models:
 VFD38AMH43AFSAA
 VFD45AMH43AFSAA

High Speed Models:
 VFD38AMH43AFSHA
 VFD45AMH43AFSHA

Frame		W	H	D	W1	H1	D1	S1
F1	mm	175.0	300.0	207.0	154.0	279.5	6.5	8.4
	inch	6.89	11.81	8.15	6.06	11.00	0.26	0.33
Frame		W	H	D	W1	H1	D1	S1
F2	mm	175.0	300.0	259.0	154.0	279.5	6.5	8.4
	inch	6.89	11.81	10.20	6.06	11.00	0.26	0.33

Frame G

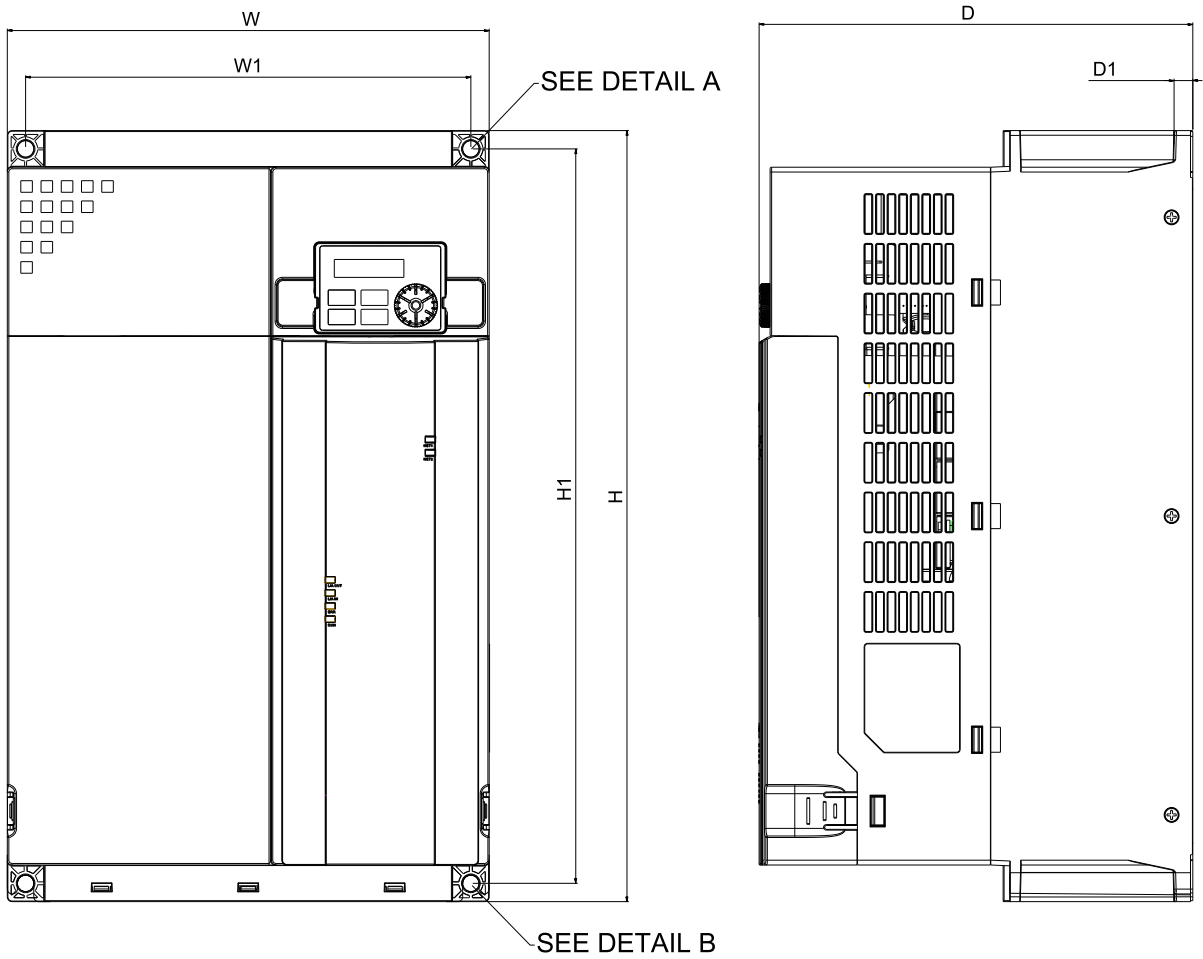

Detail A (Mounting Hole) Detail B (Mounting Hole)

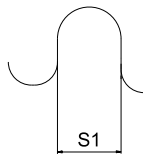
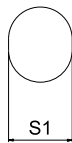

MODEL FRAME G

VFD60AMH43AFSAA
VFD60AMH43ANSAA
VFD75AMH23ANSAA
VFD90AMH23ANSAA

Frame		W	H	D	W1	H1	D1	S1
G	mm	250.0	400.0	225.0	231.0	381.0	10.0	8.5
	inch	9.84	15.75	8.86	9.09	15.00	0.39	0.33

Frame H

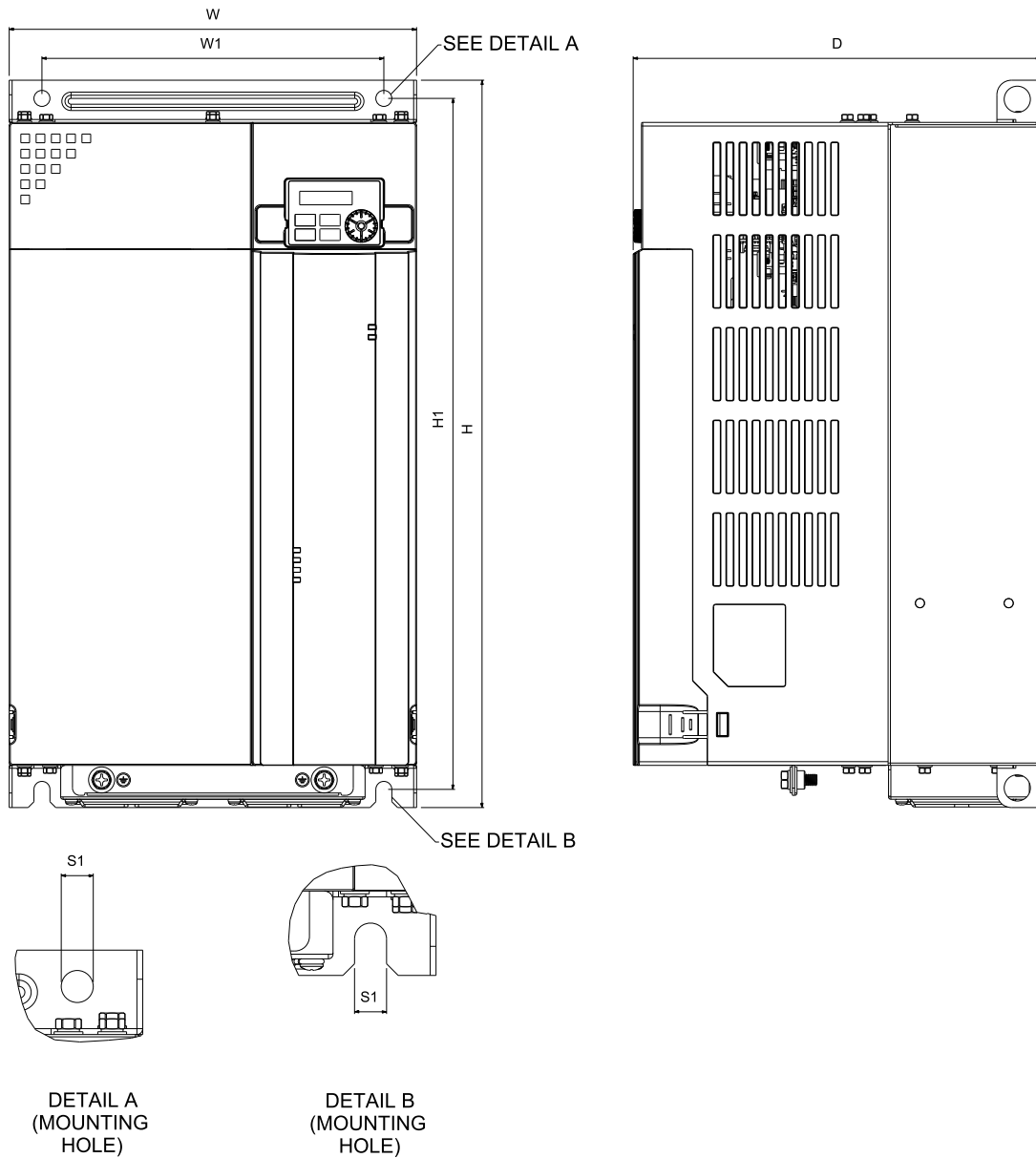

MODEL FRAME H

VFD75AMH43AFSAA
 VFD75AMH43ANSAA
 VFD91AMH43AFSAA
 VFD91AMH43ANSAA

Frame		W	H	D	W1	H1	D1	S1
H	mm	280.0	500.0	280.0	235.0	475.0	11.0	8.4
	inch	11.02	19.69	11.02	9.25	18.70	0.43	0.33

Frame I

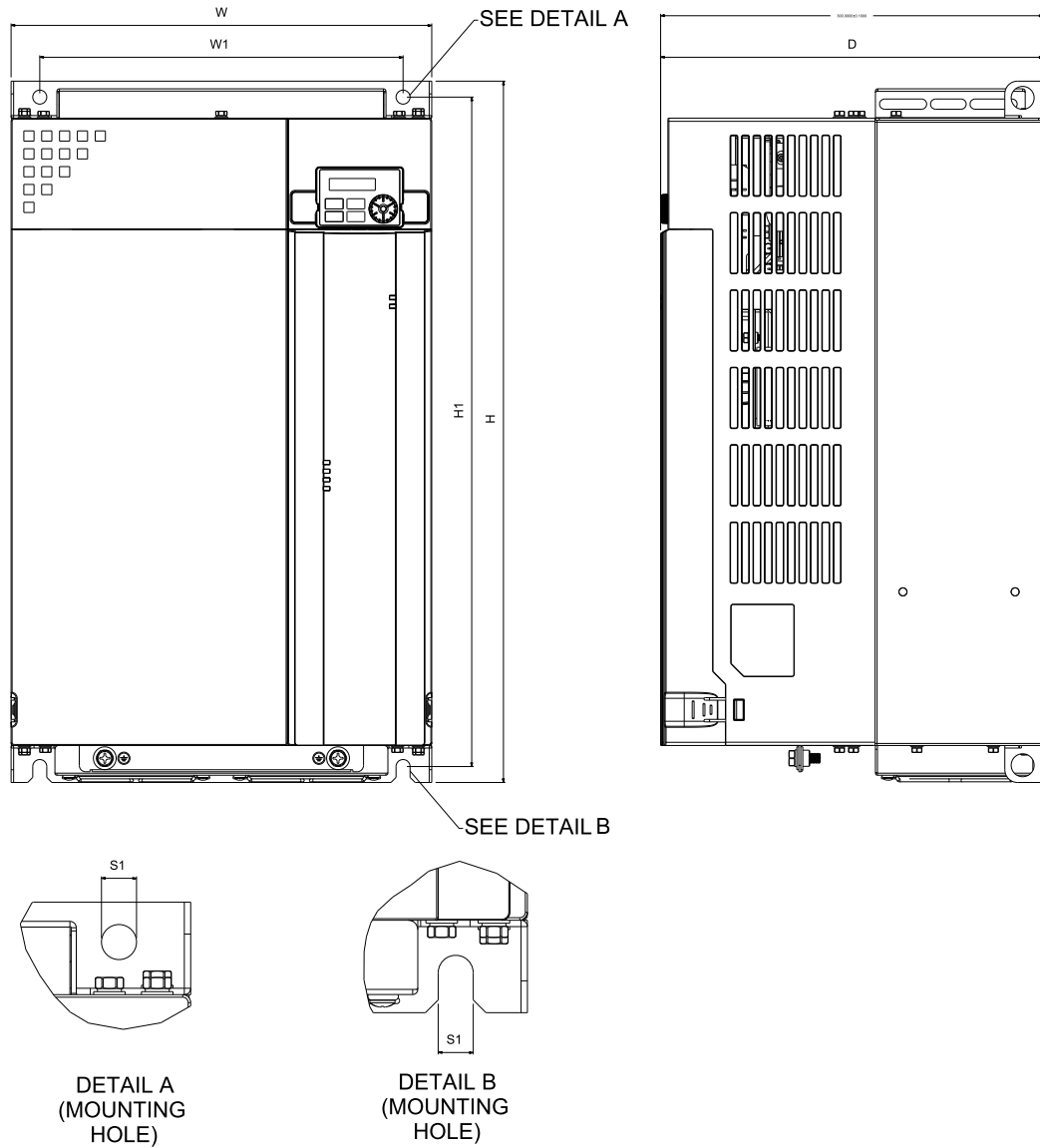

MODEL FRAME I

VFD112MH43AFSAA
 VFD112MH43ANSAA
 VFD120MH23ANSAA
 VFD146MH23ANSAA
 VFD150MH43AFSAA
 VFD150MH43ANSAA

Frame		W	H	D	W1	H1	S1
I	mm	330.0	550.0	300.0	285.0	525.0	11.0
	inch	12.99	21.65	11.81	11.22	20.67	0.43

Accessories

PG Cards: EMM-PG01L



Set by Pr.10-00~10-02

Terminals	Description	
PG1	VP	Output voltage for power: +5V/+12V ± 5% (use FSW3 to switch +5V/+12 V, default +5V) Max. output current: 200 mA
	DCM	Common for power and signal
	A1, /A1 B1, /B1 Z1, /Z1	Encoder input signal (Line Driver or Open Collector) Open collector input: + 5 V ~ 24 V (Note 1) 1-phase or 2-phase input / Max. input frequency: 300 kHz
PG2	A2, /A2 B2, /B2	Pulse input signal (line driver or open collector) Open collector input: +5V/+12V (Note1) 1-phase or 2-phase input/Max. input frequency: 300 kHz
PG OUT	AO, /AO BO, /BO ZO, /ZO SG	PG card output signals / Division frequency function: 1 ~ 255 times Max. output voltage for line driver: 5V _{DC} Max. output current: 15 mA/Max. output frequency: 300 kHz SG: The GND of PG card is the same as the host controller or PLC, and a common output signal is attained
Ground	PE	Earthing terminal to reduce noise; this terminal should also be grounded

PG Cards: EMM-PG01O



Set by Pr.10-00~10-02

Terminals	Description	
PG1	VP	Output voltage for power: +5V/+12V ± 5% (use SSW320 to switch +5V / +12V, the default is +5V) Max. output current: 200 mA
	DCM	Common for power and signal
	A1, /A1 B1, /B1 Z1, /Z1	Encoder input signal (line driver or open collector) Open collector input: +5V~+12V (Note1) 1-phase or 2-phase input/Max. input frequency: 300 kHz
PG2	A2, /A2 B2, /B2	Pulse input signal (line driver or open collector) Open collector input: +5V~+12V (Note1) 1-phase or 2-phase input/Max. input frequency: 300 kHz
PG OUT	V+	Needs external power source for PG OUT circuit. Input voltage of power: +7V~+24V
	V-	Negative power supply input
	/AO, /BO, /ZO SG	PG card output signals / Division frequency function: 1 ~ 255 times Add a pull-up resistor (1.8KΩ/1W) to the open collector output signals to avoid signal interferences Max. Output current: 20 mA/Max output frequency: 300 kHz SG: The GND of PG card is the same as the host controller or PLC, and a common output signal is attained
Ground	PE	Earthing terminal to reduce noise; this terminal should also be grounded

PG Cards: EMM-PG01R



Resolver
Set by Pr.10-00~10-02

Terminals	Description	
PG1	R1- R2	Resolver output power 7V _{rms} , 10 kHz
	S1, S2, S3, S4	Resolver input signal 3.5 ± 0.175 V _{rms} , 10 kHz
PG2	A2, /A2 B2, /B2	Pulse input signal (line driver or open collector) Open collector input : +5V~+12V (Note1) 1-phase or 2-phase input/Max. input frequency: 300kHz
PG OUT	AO, /AO BO, /BO ZO, /ZO SG	PG card output signals / Division frequency function: 1 ~ 255 times Max. output voltage for line driver: 5V _{DC} Max. output current: 50 mA/Max. output frequency: 300 kHz SG: The GND of PG card is the same as the host controller or PLC, and a common output signal is attained
Ground	PE	Earthing terminal to reduce noise; this terminal should also be grounded

External Power Supply Card (DC 24V): EMM-BPS02



Terminals	Description
PE GND 24V	When the AC motor drive power is off, the external power supply card provides external power to the network system, PLC function, and other functions to allow continued operations Input power: 24 V ± 5% Maximum input current: 0.5A Note: 1) Do not connect the control terminal +24V (Digital control signal common: SOURCE) directly to the EMC-BPS02 input terminal 24V 2) Do not connect control terminal GND directly to the EMC-BPS02 input terminal GND in order to achieve good isolation

Note 1: For the open collector, set input voltage to 5 ~ 15 mA and install a pull-up resistor

[5V] Recommend pull-up resistor: 100 ~ 220Ω, 1/2W and above

[12V] Recommend pull-up resistor: 510 ~ 1.35KΩ, 1/2W and above

[24V] Recommend pull-up resistor: 1.8K ~ 3.3KΩ, 1/2W and above

Accessories

▪ Digital I/O Card: EMM-D33A

	Terminals	Description
	24V, DCM	Output power: +24 V _{DC} ± 5% 200 mA, 5W
	MI10~MI12	Refer to Pr. 02-26~Pr. 02-28 to program the multi-function Choose SINK (NPN)/SOURCE (PNP) from SWW1 Internal power is supplied by terminal 24V: +24 V _{DC} ± 5% 200 mA, 5W If external power is +24 V _{DC} , the max. voltage is 30 V _{DC} and the min. voltage is 19 V _{DC} ON: the activation current is 6.5 mA OFF: leakage current tolerance is 10 μA
	MO10~MO12	Refer to Pr. 02-36~Pr. 02-38 to program the multi-function The motor drive releases various monitor signals, such as drive in operation, frequency attained and overload indication, via transistor (open collector) MO output signal: each MO terminal needs a pull-up resistor, the max. external power voltage is 48 V _{DC} /50 mA
	MCM	Common for multi-function output terminals MO10~MO12 (photocoupler)
	PE	Earthing terminal to reduce noise; this terminal should also be grounded

▪ Analog I/O Card: EMM-A22A

	Terminals	Description
	ACM	Common output signal and input signal terminals
	AI10, AI11	Refer to Pr. 14-00~Pr. 14-01 to program the multi-function Two AI ports: switch between J9, J19 for AVI or ACI AVI10~AVI11: input 0~10.00 V ± 0.05 V ACI10~ACI11: input 0~20.00 mA ± 0.05 mA
	AO10, AO11	Refer to Pr. 14-12~Pr. 14-13 to program the multi-function Two AO ports: switch between J2, J22 for AVO or ACO AVO10~AVO11: output 0~10.00 V ± 0.05 V ACO10~ACO11: output 0~20.00 mA ± 0.05 mA
	PE	Earthing terminal to reduce noise; this terminal should also be grounded

▪ Relay Cards:

EMM-R2CA

	Terminals	Description
	RA10~RA11 RB10~RB11 RC10~RC11	Refer to Pr. 02-36~Pr. 02-37 to program the multi-function Resistive load: 5A (N.O.)/240 V _{AC} Function: To output each monitor signal, such as drive is in operation, frequency attained or overload indication

EMM-R3AA

	Terminals	Description
	RA10~RA12 RC10~RC12	Refer to Pr. 02-36~Pr. 02-38 to program the multi-function Resistive load: 6A (N.O.)/250 V _{AC} Function: To output each monitor signal, such as drive is in operation, frequency attained or overload indication

▪ Screw Specification of Option Card Terminals

Screw Specification of Option Card Terminals	Wire Gauge	Torque	Screw Specification of Option Card Terminals	Wire Gauge	Torque
EMM-PG01L	30~16 AWG (0.0509~1.31 mm ²)	2 Kg-cm [1.74 lb-in]	EMM-BPS02	30~16AWG (0.0509~1.31 mm ²)	8 Kg-cm [6.94 lb-in]
EMM-PG01O			EMM-R2CA	24~12 AWG	5 Kg-cm
EMM-PG01R			EMM-R3AA	(0.205~3.31 mm ²)	[4.34 lb-in]
EMM-A22A					
EMM-D33A					
CMM-EIP02					
CMM-EIP03					
CMM-EC02					
CMM-PD02					
CMM-DN02					

Option cards require working with the cables models of CBM-CLxxA / CBM-CCxxA. For more details, please refer to the MH300 user manual.

▪ **EtherNet/IP, Modbus TCP Option Card**

CMM-EIP02 / CMM-EIP03

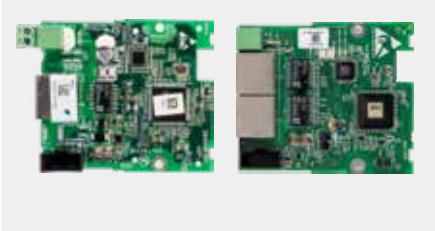

Features

- ▶ Supports max. 32 words input and 32 words output of I/O connection
- ▶ User-defined parameter mapping
- ▶ IP Filter, basic firewall function
- ▶ Supports DLR ring node * applied to CMM-EIP03

Network Interface

Network Protocol	DHCP、BOOTP、EtherNet/IP、Modbus TCP	Interface	RJ-45
Transmission Speed	10/100Mbps	Number of Ports	1 (CMM-EIP02) / 2 (CMM-EIP03)
Transmission Method	I/O connection/Explicit message	Transmission Cable	Category 5e shielding
Transmission Distance	100m, extension is allowed via switch		

▪ **DeviceNet Option Card**

CMM-DN02



Features

- ▶ Supports Group 2 only connection method and cyclic I/O data exchange
- ▶ Provides EDS file to identify DeviceNet equipment information
- ▶ Supports max. 32 words input and 32 words output of parameter mapping and remote I/O function
- ▶ Node address and baud rate can be set in the AC motor drive

Network Interface

Network Protocol	DeviceNet	Interface	Terminal block
Transmission Speed	500k/250k/125k/100k/50k bps and extendable baud rate mode of 1M	Number of Ports	1
Transmission Method	Explicit message/Implicit message	Transmission Cable	Delta standard
Transmission Distance	25m / 1Mbps		

▪ **PROFIBUS DP Card**

CMM-PD02



Features

- ▶ Supports PZD cyclic data exchange
- ▶ Supports user diagnosis function
- ▶ Supports PKW read/write to AC motor drive parameters
- ▶ Auto-detects baud rates; supports max. 12 Mbps
- ▶ Supports remote I/O function

Network Interface

Network Protocol	PROFIBUS DP	Interface	DB9
Transmission Speed	9.6k/19.2k/93.75k/187.5k/500k/1.5M/3M/6M/12Mbps	Number of Ports	1
Transmission Method	Cyclic/non-cyclic data exchange	Transmission Cable	Delta standard
Transmission Distance	100m / 12Mbps		

Accessories

▪ EtherCAT Option Card

CMM-EC02



Features

- ▶ Supports Ethernet CAT protocol
- ▶ Supports standard CiA402 speed mode
- ▶ Supports SDO (Service Data Objects) function: Drive status reading and parameters editing
- ▶ Auto shutdown function for interruptions during data transmission
- ▶ Supports remote I/O function

Network Interface

Interface	RJ-45	Transmission Cable	Category 5e shielding 100M
Number of Ports	2	Transmission Speed	100Mbps
Transmission Method	IEEE 802.3, IEEE 802.3u	Network Protocol	EtherCAT

▪ Standard Fieldbus Cables

Delta Cables	Part Number	Description	Length
CANopen Cable	UC-CmC003-01A	CANopen cable, RJ45 connector	0.3m
	UC-CmC005-01A		0.5m
	UC-CmC010-01A		1m
	UC-CmC015-01A		1.5m
	UC-CmC020-01A		2m
	UC-CmC030-01A		3m
	UC-CmC050-01A		5m
	UC-CmC100-01A		10m
	UC-CmC200-01A		20m
DeviceNet Cable	UC-DN01Z-01A	DeviceNet cable	305m
	UC-DN01Z-02A		305m
EtherNet/EtherCAT Cable	UC-EmC003-02A	EtherNet/EtherCAT cable, Shielding	0.3m
	UC-EmC005-02A		0.5m
	UC-EmC010-02A		1m
	UC-EmC020-02A		2m
	UC-EmC050-02A		5m
	UC-EmC100-02A		10m
	UC-EmC200-02A		20m
CANopen/DeviceNet TAP	TAP-CN01	1 in 2 out, built-in 121Ω terminal resistor	1 in 2 out
	TAP-CN02		1 in 2 out, RJ45
	TAP-CN03	1 in 4 out, RJ45 connector, built-in 121Ω terminal resistor	1 in 4 out
PROFIBUS Cable	UC-PF01Z-01A	PROFIBUS DP cable	305 m

Extension Cable for Digital Keypad

- RJ45 Extension Cable/CANopen Communication Cable

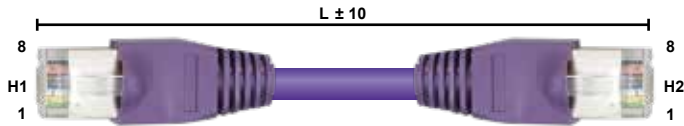

Part No.	L	
	mm	inch
UC-CMC003-01A	300	11.8
UC-CMC005-01A	500	19.6
UC-CMC010-01A	1,000	39
UC-CMC015-01A	1,500	59
UC-CMC020-01A	2,000	78.7
UC-CMC030-01A	3,000	118.1
UC-CMC050-01A	5,000	196.8
UC-CMC100-01A	10,000	393.7
UC-CMC200-01A	20,000	787.4

Model Name Explanation

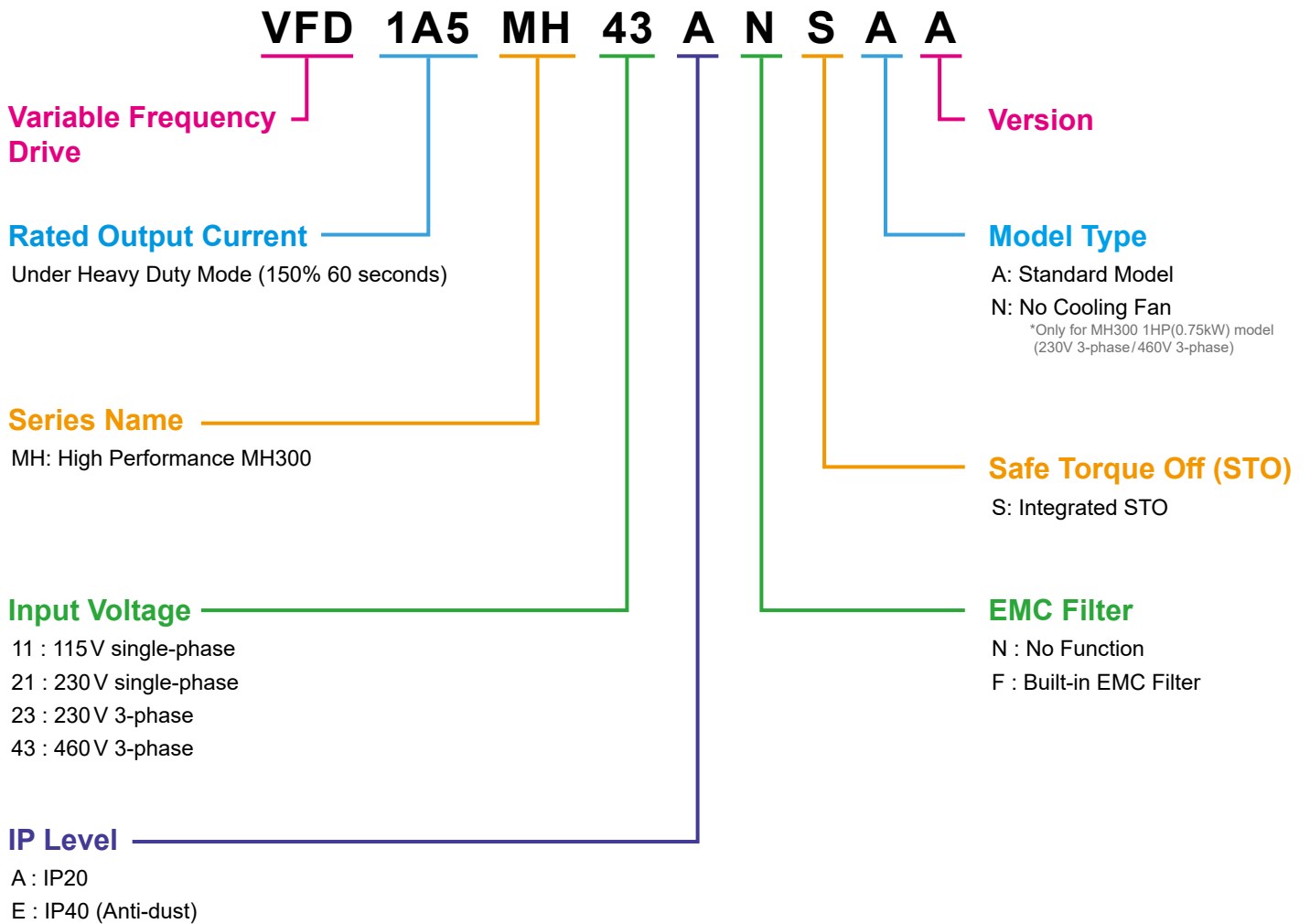

Ordering Information

Power Range			Frame Size	Model Name	Standard Models (0 ~ 599 Hz)		
Max. Applicable Motor Capacity		Drive Rated Output Current			Built-in EMC Filter	IP40 Models	F: Forced air cooling N: Natural air cooling
[HP]	[kW]	[A]					
115 V / single-phase							
0.25	0.2	1.6	A	VFD1A6MH11ANSAA	-	-	N
				VFD1A6MH11ENSAA	-	V	N
0.5	0.4	2.5	A	VFD2A5MH11ANSAA	-	-	N
				VFD2A5MH11ENSAA	-	V	N
1	0.75	5.0	C	VFD5A0MH11ANSAA	-	-	F
				VFD5A0MH11ENSAA	-	V	F
230 V / single-phase							
0.25	0.2	1.6	A	VFD1A6MH21ANSAA	-	-	N
			A	VFD1A6MH21ENSAA	-	V	N
			B	VFD1A6MH21AFSAA	V	-	N
0.5	0.4	2.8	A	VFD2A8MH21ANSAA	-	-	N
			A	VFD2A8MH21ENSAA	-	V	N
			B	VFD2A8MH21AFSAA	V	-	F
1	0.75	5.0	B	VFD5A0MH21ANSAA	-	-	N
				VFD5A0MH21AFSAA	V	-	F
				VFD5A0MH21ENSAA	-	V	N
2	1.5	7.5	C	VFD7A5MH21ANSAA	-	-	F
				VFD7A5MH21AFSAA	V	-	F
				VFD7A5MH21ENSAA	-	V	F
3	2.2	11.0	C	VFD11AMH21ANSAA	-	-	F
				VFD11AMH21AFSAA	V	-	F
				VFD11AMH21ENSAA	-	V	F
230 V / 3-phase							
0.25	0.2	1.6	A	VFD1A6MH23ANSAA	-	-	N
				VFD1A6MH23ENSAA	-	V	N
0.5	0.4	2.8	A	VFD2A8MH23ANSAA	-	-	N
				VFD2A8MH23ENSAA	-	V	N
1	0.75	5.0	A	VFD5A0MH23ANSAA	-	-	F
				VFD5A0MH23ENSAA	-	V	F
				VFD5A0MH23ANSNA	-	-	N
				VFD5A0MH23ENSNA	-	V	N
2	1.5	7.5	B	VFD7A5MH23ANSAA	-	-	F
				VFD7A5MH23ENSAA	-	V	F
3	2.2	11.0	C	VFD11AMH23ANSAA	-	-	F
				VFD11AMH23ENSAA	-	V	F
5	3.7/4	17.0	C	VFD17AMH23ANSAA	-	-	F
				VFD17AMH23ENSAA	-	V	F
7.5	5.5	25.0	D	VFD25AMH23ANSAA	-	-	F
				VFD25AMH23ENSAA	-	V	F
10	7.5	33.0	E	VFD33AMH23ANSAA	-	-	F
				VFD33AMH23ENSAA	-	V	F
15	11	49.0	E	VFD49AMH23ANSAA	-	-	F
				VFD49AMH23ENSAA	-	V	F
20	15	65.0	F	VFD65AMH23ANSAA	-	-	F
				VFD65AMH23ENSAA	-	V	F
25	18.5	75	G	VFD75AMH23ANSAA	-	-	F
30	22	90		VFD90AMH23ANSAA	-	-	F
40	30	120	I	VFD120MH23ANSAA	-	-	F
50	37	146		VFD146MH23ANSAA	-	-	F

Power Range			Frame Size	Model Name	Standard Models (0~599 Hz)		
Max. Applicable Motor Capacity		Drive Rated Output Current			Built-in EMC Filter	IP40 Models	F: Forced air cooling N: Natural air cooling
[HP]	[kW]	[A]					
460V/3-phase							
0.5	0.4	1.5	A	VFD1A5MH43ANSAA	-	-	N
			A	VFD1A5MH43ENSAA	-	V	N
			B	VFD1A5MH43AFSAA	V	-	F
1	0.75	3.0	A	VFD3A0MH43ANSAA	-	-	F
			A	VFD3A0MH43ENSAA	-	V	F
			B	VFD3A0MH43AFSAA	V	-	F
			A	VFD3A0MH43ANSNA			N
2	1.5	4.2	B	VFD4A2MH43ANSAA	-	-	F
				VFD4A2MH43ENSAA	-	V	F
				VFD4A2MH43AFSAA	V	-	F
				A	VFD3A0MH43ANSNA		
3	2.2	5.7	C	VFD5A7MH43ANSAA	-	-	F
				VFD5A7MH43ENSAA	-	V	F
				VFD5A7MH43AFSAA	V	-	F
				A	VFD3A0MH43ENSNA		V
5	3.7/4	9.0	C	VFD9A0MH43ANSAA	-	-	F
				VFD9A0MH43ENSAA	-	V	F
				VFD9A0MH43AFSAA	V	-	F
7.5	5.5	13.0	D	VFD13AMH43ANSAA	-	-	F
				VFD13AMH43ENSAA	-	V	F
				VFD13AMH43AFSAA	V	-	F
10	7.5	17.5	D	VFD17AMH43ANSAA	-	-	F
				VFD17AMH43ENSAA	-	V	F
				VFD17AMH43AFSAA	V	-	F
15	11	25.0	E	VFD25AMH43ANSAA	-	-	F
				VFD25AMH43ENSAA	-	V	F
				VFD25AMH43AFSAA	V	-	F
20	15	32.0	E	VFD32AMH43ANSAA	-	-	F
				VFD32AMH43ENSAA	-	V	F
				VFD32AMH43AFSAA	V	-	F
25	18.5	38.0	F	VFD38AMH43ANSAA	-	-	F
				VFD38AMH43ENSAA	-	V	F
				VFD38AMH43AFSAA	V	-	F
30	22	45.0	F	VFD45AMH43ANSAA	-	-	F
				VFD45AMH43ENSAA	-	V	F
				VFD45AMH43AFSAA	V	-	F
40	30	60	G	VFD60AMH43AFSAA	V	-	F
				VFD60AMH43ANSAA	-	-	F
50	37	75	H	VFD75AMH43AFSAA	V	-	F
				VFD75AMH43ANSAA	-	-	F
60	45	91	H	VFD91AMH43AFSAA	V	-	F
				VFD91AMH43ANSAA	-	-	F
75	55	112	I	VFD112MH43AFSAA	V	-	F
				VFD112MH43ANSAA	-	-	F
100	75	150	I	VFD150MH43AFSAA	V	-	F
				VFD150MH43ANSAA	-	-	F



Smarter. Greener. Together.

Industrial Automation Headquarters

Delta Electronics, Inc.

Taoyuan Technology Center
No.18, Xinglong Rd., Taoyuan District,
Taoyuan City 33068, Taiwan
TEL: 886-3-362-6301 / FAX: 886-3-371-6301

Asia

Delta Electronics (Shanghai) Co., Ltd.

No.182 Minyu Rd., Pudong Shanghai, P.R.C.
Post code : 201209
TEL: 86-21-6872-3988 / FAX: 86-21-6872-3996
Customer Service: 400-820-9595

Delta Electronics (Japan), Inc.

Tokyo Office
Industrial Automation Sales Department
2-1-14 Shibadaimon, Minato-ku
Tokyo, Japan 105-0012
TEL: 81-3-5733-1155 / FAX: 81-3-5733-1255

Delta Electronics (Korea), Inc.

Seoul Office
1511, 219, Gasan Digital 1-Ro., Geumcheon-gu,
Seoul, 08501 South Korea
TEL: 82-2-515-5305 / FAX: 82-2-515-5302

Delta Energy Systems (Singapore) Pte Ltd.

4 Kaki Bukit Avenue 1, #05-04, Singapore 417939
TEL: 65-6747-5155 / FAX: 65-6744-9228

Delta Electronics (India) Pvt. Ltd.

Plot No.43, Sector 35, HSIIDC Gurgaon,
PIN 122001, Haryana, India
TEL: 91-124-4874900 / FAX : 91-124-4874945

Delta Electronics (Thailand) PCL.

909 Soi 9, Moo 4, Bangpoo Industrial Estate (E.P.Z),
Pattana 1 Rd., T.Phraksa, A.Muang,
Samutprakarn 10280, Thailand
TEL: 66-2709-2800 / FAX : 662-709-2827

Delta Electronics (Australia) Pty Ltd.

Unit 20-21/45 Normanby Rd., Notting Hill Vic 3168, Australia
TEL: 61-3-9543-3720

Americas

Delta Electronics (Americas) Ltd.

Raleigh Office
P.O. Box 12173, 5101 Davis Drive,
Research Triangle Park, NC 27709, U.S.A.
TEL: 1-919-767-3813 / FAX: 1-919-767-3969

Delta Greentech (Brasil) S/A

São Paulo Office
Rua Itapeva, 26 – 3º Andar - Bela Vista
CEP: 01332-000 – São Paulo – SP - Brasil
TEL: 55-11-3530-8643 / 55-11-3530-8640

Delta Electronics International Mexico S.A. de C.V.

Mexico Office
Gustavo Baz No. 309 Edificio E PB 103
Colonia La Loma, CP 54060
Tlalnepantla, Estado de México
TEL: 52-55-3603-9200

EMEA

Headquarters: Delta Electronics (Netherlands) B.V.

Sales: Sales.IA.EMEA@deltaww.com
Marketing: Marketing.IA.EMEA@deltaww.com
Technical Support: iatechnicalsupport@deltaww.com
Customer Support: Customer-Support@deltaww.com
Service: Service.IA.emea@deltaww.com
TEL: +31(0)40 800 3900

BENELUX: Delta Electronics (Netherlands) B.V.

De Witbogt 20, 5652 AG Eindhoven, The Netherlands
Mail: Sales.IA.Benelux@deltaww.com
TEL: +31(0)40 800 3900

DACH: Delta Electronics (Netherlands) B.V.

Coesterweg 45, D-59494 Soest, Germany
Mail: Sales.IA.DACH@deltaww.com
TEL: +49(0)2921 987 0

France: Delta Electronics (France) S.A.

ZI du bois Challand 2, 15 rue des Pyrénées,
Lisses, 91090 Evry Cedex, France
Mail: Sales.IA.FR@deltaww.com
TEL: +33(0)1 69 77 82 60

Iberia: Delta Electronics Solutions (Spain) S.L.U

Ctra. De Villaverde a Vallecas, 265 1º Dcha Ed.
Hormigueras – P.I. de Vallecas 28031 Madrid
TEL: +34(0)91 223 74 20

Carrer Llacuna 166, 08018 Barcelona, Spain

Mail: Sales.IA.Iberia@deltaww.com

Italy: Delta Electronics (Italy) S.r.l.

Via Meda 2-22060 Novedrate(CO)
Piazza Grazioli 18 00186 Roma Italy
Mail: Sales.IA.Italy@deltaww.com
TEL: +39 039 8900365

Russia: Delta Energy System LLC

Vereyskaya Plaza II, office 112 Vereyskaya str.
17 121357 Moscow Russia
Mail: Sales.IA.RU@deltaww.com
TEL: +7 495 644 3240

Turkey: Delta Greentech Elektronik San. Ltd. Sti. (Turkey)

Şerifaii Mah. Hendem Cad. Kule Sok. No:16-A
34775 Ümraniye – İstanbul
Mail: Sales.IA.Turkey@deltaww.com
TEL: + 90 216 499 9910

GCC: Delta Energy Systems AG (Dubai BR)

P.O. Box 185668, Gate 7, 3rd Floor, Hamarain Centre
Dubai, United Arab Emirates
Mail: Sales.IA.MEA@deltaww.com
TEL: +971(0)4 2690148

Egypt + North Africa: Delta Electronics

Unit 318, 3rd Floor, Trivium Business Complex, North 90 street,
New Cairo, Cairo, Egypt
Mail: Sales.IA.MEA@deltaww.com