



Digitized Automation for a Changing World

Delta Compact Elevator Drive MH300-L



 www.deltaww.com

 **DELTA**
Smarter. Greener. Together.

Overview

Compact design, quick and easy installation, user-friendly operation

Size reduction 40%

Up to 40% size reduction compared with current drives for elevator applications



Removable Keypad
Press to remove the keypad for remote control with cable connection



Removable RFI Jumper
Applicable for different needs



Removable Fan
Easy to replace and maintain



Screwless Front Case
Press on both side tabs to remove the case





Remove the front case

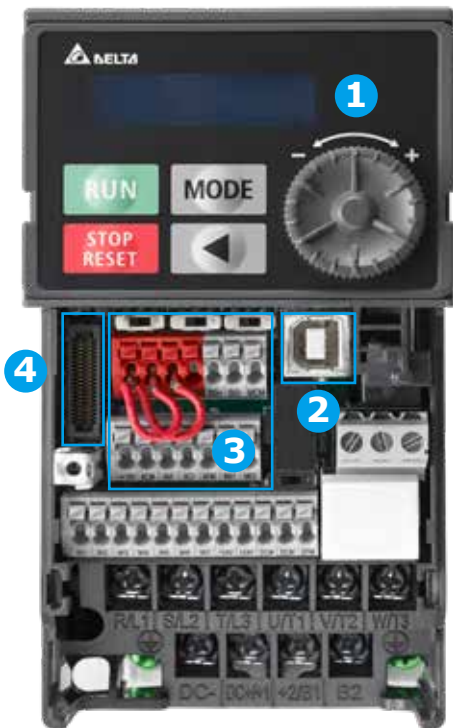

1 User-friendly Control and Display

5 digits LCD display, quick setting wheel dial and left-shift function key

2 Built-in USB Connection Port

Built-in USB connection port facilitates the drive setting, updating, real-time monitoring and system tuning process

- No external USB or RS-485 connectors needed
- Supports offline (drive power off) parameter setting / copying and system updating

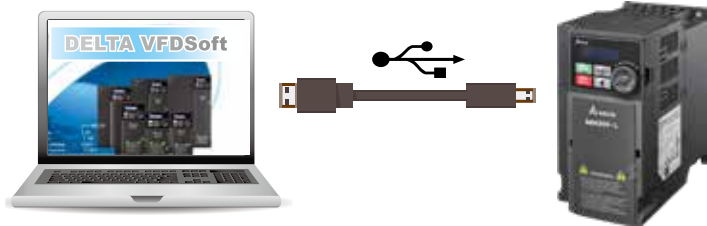

3 Screwless Wiring of Control Terminal

Spring clamp terminal blocks provide fast and easy wiring

4 Option Card

Built-in I/O slot for flexible application

I/O Extension Card (EMM-D3R2CA)



Built-in EMC Filter

Built-in Class A(C2) EMC filter, compliant with EN 12015/ EN 12016 standards for lift applications. MH300-L saves on additional procurement cost and wiring time, and provides more cabinet space

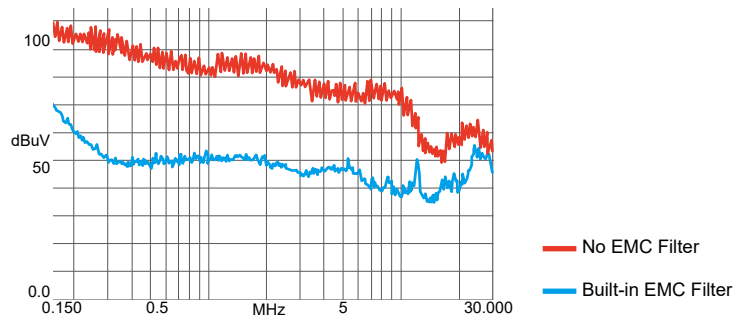

Benefits

Slip Compensation

According to current load of elevator, the slip compensation function enables the actual speed to reach rated speed accurately

Precise Time Sequence for Elevator Motion

5-Independent S-Ramps motion control provides customized parameter settings. Precise motion control at start and stop ensures smooth elevator operation

High Overload Capability

Rated current 150% for 60 seconds; 200% for 3 seconds

Versatile Communication Protocols

Built-in RS-485 (Modbus) and CAN port

Built-in PLC

Built-in PLC capacity (5k steps) to provide distributed control and independent operation via network connection

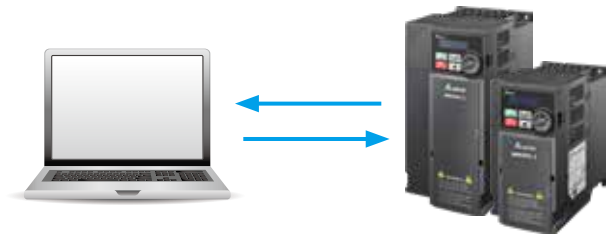

Built-in Brake Chopper

Enhance braking capability by combining an additional braking resistor

Emergency Power Supply (EPS)

EPS function will automatically switch to UPS mode when power failure happens. Drive will detect the light load direction and reach levelling floor for safety

Safety Standard

Integrated Safe Torque Off (STO), compliant with:

- EN ISO 13849-1 Cat3 / PLd
- EN 60204-1 Category 0
- EN 61508 SIL2
- EN 62061 SIL CL 2

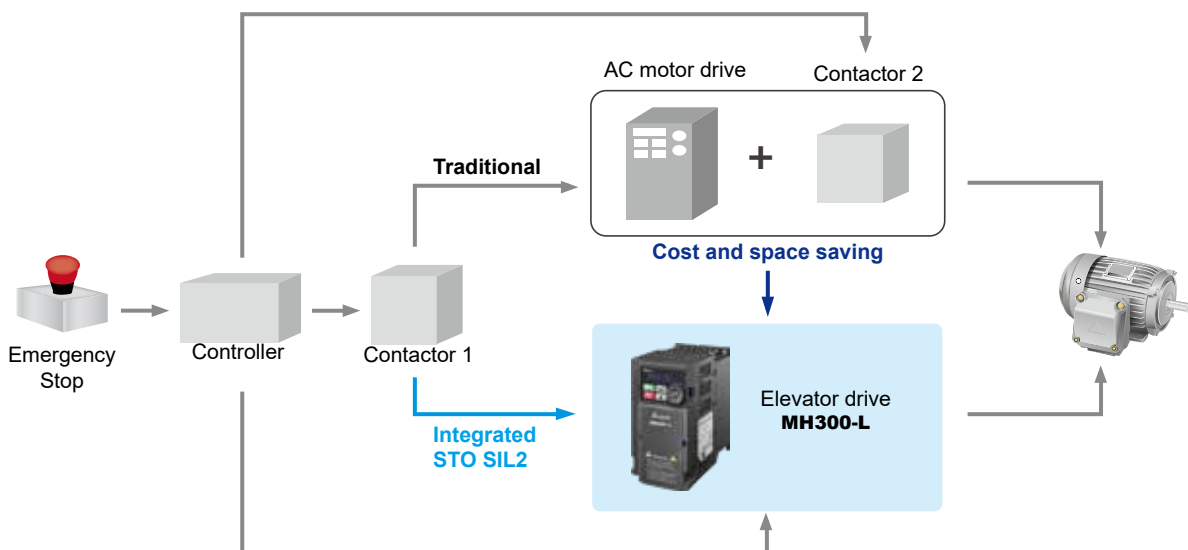

Product Specifications

3-phase 230V							
Models without built-in EMC filter							
Frame	C	D		E		F	
Applicable Motor Output (kW)	2.2	3.7	5.5	7.5	11	15	
Applicable Motor Output (HP)	3	5	7.5	10	15	20	
Output	Rated Output Capacity (kVA)	4.2	6.5	9.5	12.6	24.8	
	Rated Output Current (A)	11.0	17.0	25.0	33.0	65.0	
	Carrier Frequency (kHz)	2 ~ 15 (default 8kHz without derating)					
Input	Rated Input Current (A)	13.2	20.4	30.0	39.6	58.8	78.0
	Rated Voltage / Frequency	3-phase AC 200V ~ 240V (-15% ~ +10%), 50/60Hz					
	Operating Voltage Range	170 ~ 265 V _{AC}					
	Frequency Tolerance	47 ~ 63 Hz					
Brake Chopper	Built-in						
DC Reactor	Optional						
AC Reactor	Optional						
Weight (kg)	1.24	2.07		3.97		6.3	
Cooling Method	Fan cooling						
Dimension (W x H x D mm)	87 x 157 x 167	109 x 207 x 169		130 x 250 x 200		175 x 300 x 207	

3-phase 460V						
Models without built-in EMC filter						
Frame	C	D		E		
Applicable Motor Output (kW)	3.7	5.5	7.5	11	15	
Applicable Motor Output (HP)	5	7.5	10	15	20	
Output	Rated Output Capacity (kVA)	6.9	9.9	13.3	19.1	24.4
	Rated Output Current (A)	9.0	13.0	17.5	25.0	32.0
	Carrier Frequency (kHz)	2 ~ 15 (default 8kHz without derating)				
Input	Rated Input Current (A)	9.9	14.3	19.3	27.5	35.2
	Rated Voltage / Frequency	3-phase AC 230V ~ 480V (-15% ~ +10%), 50/60Hz				
	Operating Voltage Range	323 ~ 528 V _{AC}				
	Frequency Tolerance	47 ~ 63 Hz				
Brake Chopper	Built-in					
DC Reactor	Optional					
AC Reactor	Optional					
Weight (kg)	1.24	2.07		3.97		
Cooling Method	Fan cooling					
Dimension (W x H x D mm)	87 x 157 x 167	109 x 207 x 169		130 x 250 x 200		
Models with built-in EMC filter						
Frame	C	D		E		
Weight (kg)	1.84	2.93		5.19		
Dimension (W x H x D mm)	87 x 157 x 194	109 x 207 x 202		130 x 250 x 234		

General Specifications

Control Functions	Control Methods	V/F, SVC
	Applicant Motors	Induction Motor (IM)
	Max. Output Frequency	0 ~ 599 Hz (Default 60Hz)
	Starting Torque	150%/3Hz
	Speed Control Range	1:50
	Overload Tolerance	150% of rated output current for 60 seconds; 200% of rated output current for 3 seconds
	Frequency Setting Signal	0 ~ +10V/-10V ~ +10V, 4 ~ 20mA/0 ~ +10V, 2 pulse inputs (33 kHz), 1 pulse output (33kHz)
	Main Control Functions	Fast startup, Momentary power loss ride thru, over-torque detection, 16-step speed (max.), accel/decel time switch, S-curve accel/decel, JOG frequency, upper/lower limits for frequency reference, DC injection braking at start and stop, Built-in PLC (5 K steps), Modbus and CAN are integrated as standard
Protection Functions	Motor Protection	Overcurrent, overvoltage, over-temperature, phase loss, over-load
	Stall Prevention	Stall prevention during acceleration, deceleration and running independently
Optional Card	I/O Extension Card	EMM-D3R2CA (digital/relay card - 3 input & 2 relayC output)
Digital Keypad		Externally available operation keypad
Certifications		UL, CE, C-Tick, TUV (SIL2), RoHS, REACH

Operating Environment

Operating Environment	Installation Location	IEC60364-1 / IEC60664-1 pollution level 2, indoor use only		
	Ambient Temperature	Operation	IP20 / UL Open Type	-20 to 50 °C (derating to 60 °C)
		Storage		-40 to 85 °C
		Transportation		-20 to 70 °C
	Rated Humidity	Operation		Max. 90%
		Storage / Transportation		Max. 95%
	Air Pressure	Operation		86 ~ 106 kPa
		Storage / Transportation		70 ~ 106 kPa
	Pollution Level	Compliant with IEC60721-3-3, 3C2		
	Altitude	An altitude of 0 ~ 1000 m for normal operation (derating is required for installation at an altitude above 1000 m)		
Vibration		Compliant with IEC 60068-2-6		
Shock		Compliant with IEC/EN 60068-2-27		

Please refer to the user manual for more details

Wiring

It provides 3-phase power

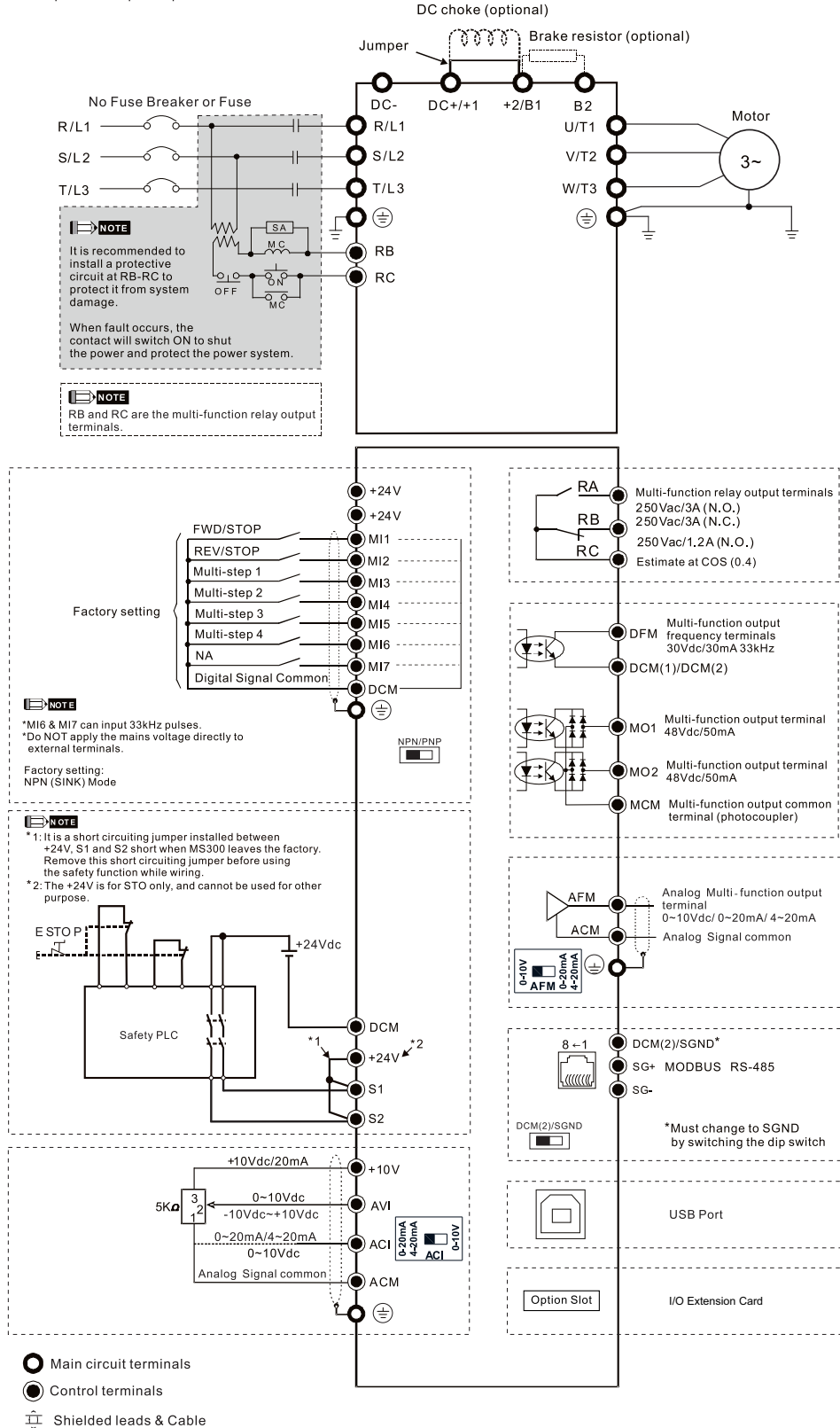

Dimensions

Frame C

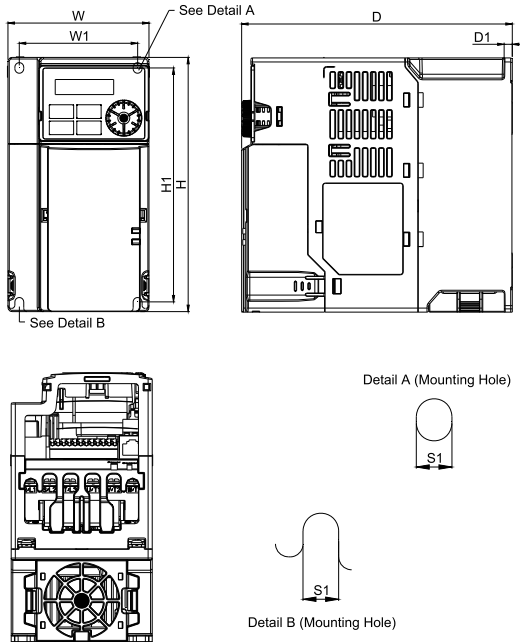

Frame D

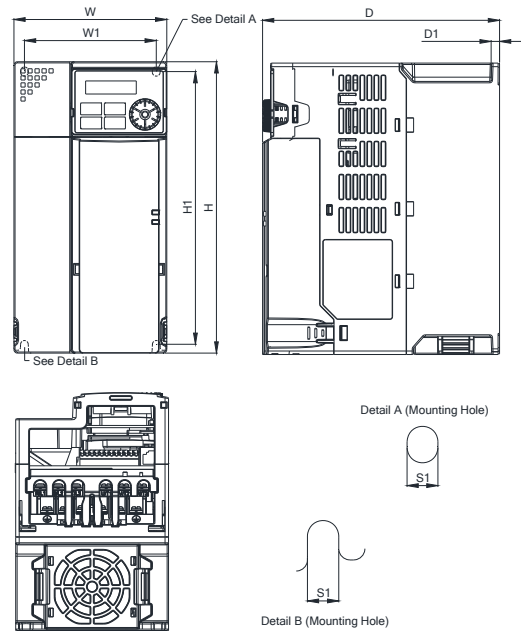

MODEL FRAME C1

VFD11AMH23ANSLA
VFD17AMH23ANSLA
VFD9A0MH43ANSLA

FRAME C2

VFD9A0MH43AFSLA

Frame		W	H	D	W1	H1	D1	S1
C1	mm	87.0	157.0	167.0	73.0	144.5	5.0	5.5
	inch	3.43	6.18	6.57	2.87	5.69	0.20	0.22
Frame		W	H	D	W1	H1	D1	S1
C2	mm	87.0	157.0	194.0	73.0	144.5	5.0	5.5
	inch	3.43	6.18	7.64	2.87	5.69	0.20	0.22

MODEL FRAME D1

VFD25AMH23ANSLA
VFD13AMH43ANSLA
VFD17AMH43ANSLA

FRAME D2

VFD13AMH43AFSLA
VFD17AMH43AFSLA

Frame		W	H	D	W1	H1	D1	S1
D1	mm	109.0	207.0	169.0	94.0	193.8	6.0	5.5
	inch	4.29	8.15	6.65	3.70	7.63	0.24	0.22
Frame		W	H	D	W1	H1	D1	S1
D2	mm	109.0	207.0	202.0	94.0	193.8	6.0	5.5
	inch	4.29	8.15	7.95	3.70	7.63	0.24	0.22

Frame E

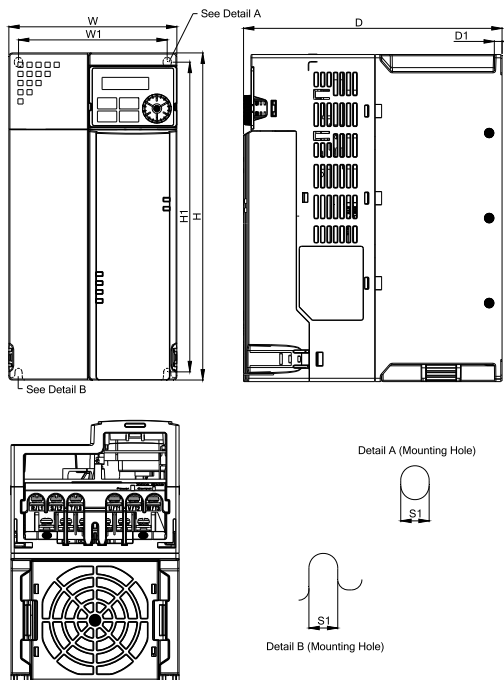

Frame F

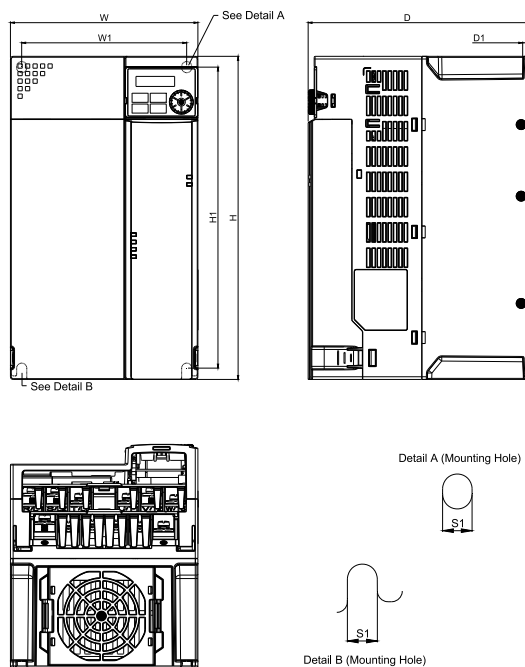

MODEL FRAME E1

VFD33AMH23ANSLA
VFD49AMH23ANSLA
VFD25AMH43ANSLA
VFD32AMH43ANSLA

FRAME E2

VFD25AMH43AFSLA
VFD32AMH43AFSLA

Frame		W	H	D	W1	H1	D1	S1
E1	mm	130.0	250.0	200.0	115.0	236.8	6.0	5.5
	inch	5.12	9.84	7.87	4.53	9.32	0.24	0.22
Frame		W	H	D	W1	H1	D1	S1
E2	mm	130.0	250.0	234.0	115.0	236.8	6.0	5.5
	inch	5.12	9.84	9.21	4.53	9.32	0.24	0.22

MODEL FRAME F1

VFD65AMH23ANSLA

Frame		W	H	D	W1	H1	D1	S1
F1	mm	175.0	300.0	207.0	154.0	279.5	6.5	8.4
	inch	6.89	11.81	8.15	6.06	11.00	0.26	0.33

Option Card

I/O Extension Card (EMM-D3R2CA)

	Terminals	Description
 I/O Extension Card	24V, DCM	Output power: $+24 V_{DC} \pm 10\% < 30mA$
	MI10 ~ MI12	Refer to Pr.02-26~Pr.02-28 to program the multi-function Choose SINK (NPN) / SOURCE (PNP) from SSW1 Internal power is supplied by terminal 24 V: $+24 V_{DC} \pm 5\%$ If external power is $+24 V_{DC}$, the maximum voltage is $30V_{DC}$ and the minimum voltage is $19V_{DC}$ ON: the activation current is 6.5mA OFF: leakage current tolerance is $10\mu A$
	PE	Earthing terminal to reduce noise; this terminal should also be grounded
	RA10 ~ RA11	Refer to Pr. 02-36~ Pr. 02-37 to program the multi-function
	RB10 ~ RB11	Resistive load: 5A(N.O.)/240 VAC Function: To output each monitor signal, such as drive is in operation, frequency attained or overload indication
	RC10 ~ RC11	

Model Name Explanation

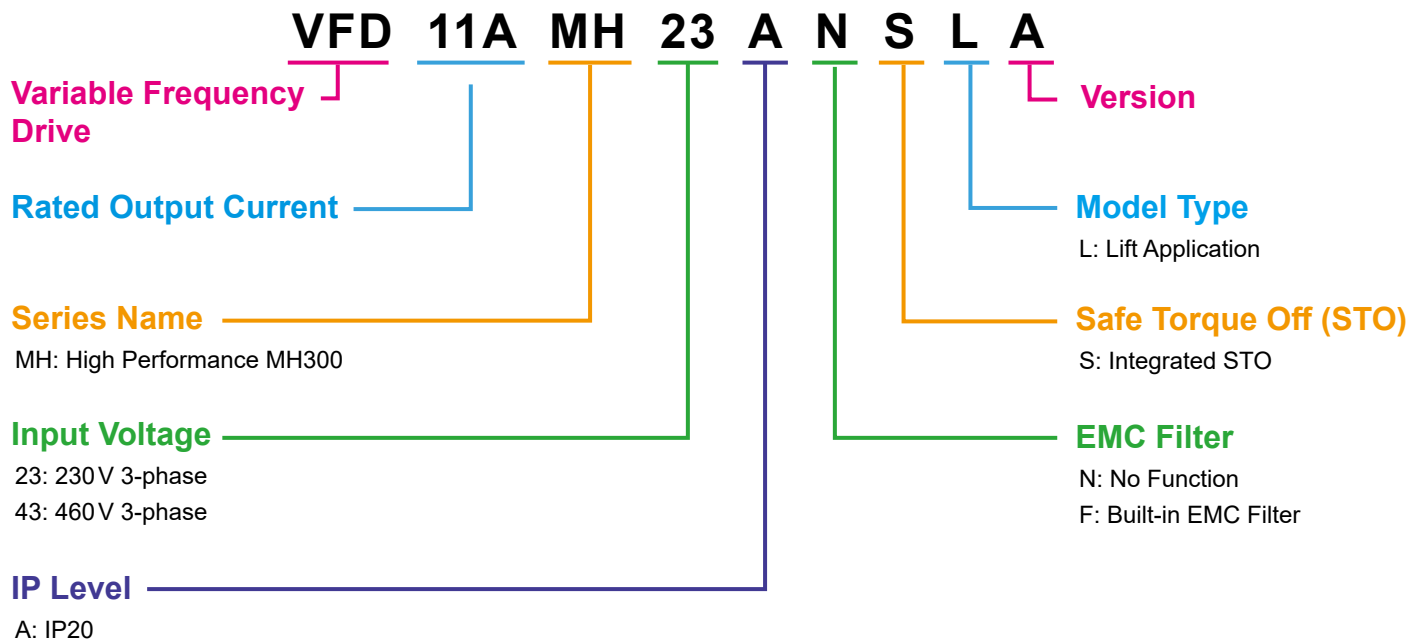

Accessories

Extension Cable for Digital Keypad

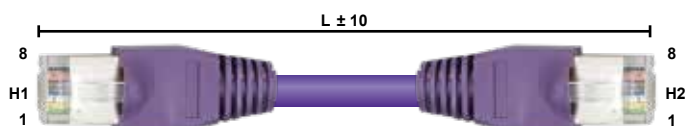

Title	Part No.	L	
		mm	inch
1	UC-CMC003-01A	300	11.8
2	UC-CMC005-01A	500	19.6
3	UC-CMC010-01A	1000	39
4	UC-CMC015-01A	1500	59
5	UC-CMC020-01A	2000	78.7
6	UC-CMC030-01A	3000	118.1
7	UC-CMC050-01A	5000	196.8
8	UC-CMC100-01A	10000	393.7
9	UC-CMC200-01A	20000	787.4

Ordering Information

Standard Models (0 ~ 599 Hz)

Power Range			Frame Size	Model Name	Built-in EMC Filter
Max. Applicable Motor Capacity		Drive Rated Output Current			
[HP]	[kW]	[A]			
230 V/3-phase					
3	2.2	11.0	C	VFD11AMH23ANSLA	-
5	3.7	17.0	C	VFD17AMH23ANSLA	-
7.5	5.5	25.0	D	VFD25AMH23ANSLA	-
10	7.5	33.0	E	VFD33AMH23ANSLA	-
15	11	49.0	E	VFD49AMH23ANSLA	-
20	15	65.0	F	VFD65AMH23ANSLA	-
460 V/3-phase					
5	3.7	9.0	C	VFD9A0MH43ANSLA	-
				VFD9A0MH43AFSLA	✓
7.5	5.5	13.0	D	VFD13AMH43ANSLA	-
				VFD13AMH43AFSLA	✓
10	7.5	17.5	D	VFD17AMH43ANSLA	-
				VFD17AMH43AFSLA	✓
15	11	25.0	E	VFD25AMH43ANSLA	-
				VFD25AMH43AFSLA	✓
20	15	32.0	E	VFD32AMH43ANSLA	-
				VFD32AMH43AFSLA	✓



Smarter. Greener. Together.

Industrial Automation Headquarters

Taiwan: Delta Electronics, Inc.

Taoyuan Technology Center
No.18, Xinglong Rd., Taoyuan District,
Taoyuan City 33068, Taiwan
TEL: +886-3-362-6301 / FAX: +886-3-371-6301

Asia

China: Delta Electronics (Shanghai) Co., Ltd.

No.182 Minyu Rd., Pudong Shanghai, P.R.C.
Post code : 201209
TEL: +86-21-6872-3988 / FAX: +86-21-6872-3996
Customer Service: 400-820-9595

Japan: Delta Electronics (Japan), Inc.

Industrial Automation Sales Department
2-1-14 Shibadaimon, Minato-ku
Tokyo, Japan 105-0012
TEL: +81-3-5733-1155 / FAX: +81-3-5733-1255

Korea: Delta Electronics (Korea), Inc.

1511, 219, Gasan Digital 1-Ro., Geumcheon-gu,
Seoul, 08501 South Korea
TEL: +82-2-515-5305 / FAX: +82-2-515-5302

Singapore: Delta Energy Systems (Singapore) Pte Ltd.

4 Kaki Bukit Avenue 1, #05-04, Singapore 417939
TEL: +65-6747-5155 / FAX: +65-6744-9228

India: Delta Electronics (India) Pvt. Ltd.

Plot No.43, Sector 35, HSIIDC Gurgaon,
PIN 122001, Haryana, India
TEL: +91-124-4874900 / FAX: +91-124-4874945

Thailand: Delta Electronics (Thailand) PCL.

909 Soi 9, Moo 4, Bangpoo Industrial Estate (E.P.Z),
Pattana 1 Rd., T.Phraksa, A.Muang,
Samutprakarn 10280, Thailand
TEL: +66-2709-2800 / FAX: +66-2709-2827

Australia: Delta Electronics (Australia) Pty Ltd.

Unit 20-21/45 Normanby Rd., Notting Hill Vic 3168, Australia
TEL: +61-3-9543-3720

Americas

USA: Delta Electronics (Americas) Ltd.

5101 Davis Drive, Research Triangle Park, NC 27709, U.S.A.
TEL: +1-919-767-3813 / FAX: +1-919-767-3969

Brazil: Delta Electronics Brazil

Rua Itapeva, 26 - 3º, andar Edifício Itapeva,
One - Bela Vista 01332-000 - São Paulo - SP - Brazil
TEL: +55-12-3932-2300 / FAX: +55-12-3932-237

Mexico: Delta Electronics International Mexico S.A. de C.V.

Gustavo Baz No. 309 Edificio E PB 103
Colonia La Loma, CP 54060
Tlalnepantla, Estado de México
TEL: +52-55-3603-9200

EMEA

EMEA Headquarters: Delta Electronics (Netherlands) B.V.

Sales: Sales.IA.EMEA@deltaww.com
Marketing: Marketing.IA.EMEA@deltaww.com
Technical Support: iatechnicalsupport@deltaww.com
Customer Support: Customer-Support@deltaww.com
Service: Service.IA.emea@deltaww.com
TEL: +31(0)40 800 3900

BENELUX: Delta Electronics (Netherlands) B.V.

Automotive Campus 260, 5708 JZ Helmond, The Netherlands
Mail: Sales.IA.Benelux@deltaww.com
TEL: +31(0)40 800 3900

DACH: Delta Electronics (Netherlands) B.V.

Coesterweg 45, D-59494 Soest, Germany
Mail: Sales.IA.DACH@deltaww.com
TEL: +49(0)2921 987 0

France: Delta Electronics (France) S.A.

ZI du bois Challand 2, 15 rue des Pyrénées,
Lisses, 91090 Evry Cedex, France
Mail: Sales.IA.FR@deltaww.com
TEL: +33(0)1 69 77 82 60

Iberia: Delta Electronics Solutions (Spain) S.L.U

Ctra. De Villaverde a Vallecas, 265 1º Dcha Ed.
Hormigueras – P.I. de Vallecas 28031 Madrid
TEL: +34(0)91 223 74 20

Carrer Llacuna 166, 08018 Barcelona, Spain

Mail: Sales.IA.Iberia@deltaww.com

Italy: Delta Electronics (Italy) S.r.l.

Via Meda 2-22060 Novedrate(CO)
Piazza Grazioli 18 00186 Roma Italy
Mail: Sales.IA.Italy@deltaww.com
TEL: +39 039 8900365

Russia: Delta Energy System LLC

Vereyskaya Plaza II, office 112 Vereyskaya str.
17 121357 Moscow Russia
Mail: Sales.IA.RU@deltaww.com
TEL: +7 495 644 3240

Turkey: Delta Greentech Elektronik San. Ltd. Sti. (Turkey)

Şerifali Mah. Hendem Cad. Kule Sok. No:16-A
34775 Ümraniye – İstanbul
Mail: Sales.IA.Turkey@deltaww.com
TEL: + 90 216 499 9910

MEA: Eltek Dubai (Eltek MEA DMCC)

OFFICE 2504, 25th Floor, Saba Tower 1,
Jumeirah Lakes Towers, Dubai, UAE
Mail: Sales.IA.MEA@deltaww.com
TEL: +971(0)4 2690148

*We reserve the right to change the information in this catalogue without prior notice.